



KATALOG PROIZVODA AUTOBUSI
PRODUCT CATALOGUE BUSES
WARENKATALOG BUSSE

2017. godina
I IZDANJE

METALAC FAD d.o.o
Ul. Kneza Aleksandra 210
32300 Gornji Milanovac, Srbija

telefon +381 32 5155 200
fax +381 32 770 489
e-mail fad@metalac.com
www.metalacfad.com

 Succeed with Quality		<h1>CERTIFICATE</h1>	
Quality Austria Trainings-, Zertifizierungs- und Begutachtungs GmbH awards this qualityaustria certificate to the following organisation:		This qualityaustria certificate confirms the application and further development of an effective	
METALAC FAD d.o.o. RS-32300 Gornji Milanovac, Kneza Aleksandra 210		QUALITY MANAGEMENT SYSTEM complying with the requirements of standard ISO/TS 16949:2009 without product design	
Steering and suspension parts production		Registration No.: 01572/0 IATF-Registration No.: 0222452 Issue Date: 28 October 2015 Expiration Date: 14 September 2018	
		Vienna, 28 October 2015	
<small>Dok. Nr. FO_24_203 009940c-6f5a-4a6c-9b3d-5e82b7e6920f</small>		Quality Austria Trainings-, Zertifizierungs- und Begutachtungs GmbH, A-1010 Vienna, Zelinkagasse 10/3	
		 Konrad Scheiber General Manager	 Ing. Michael Dragosits, MSc Specialist representative
		Page 1 / 1	

 Succeed with Quality		<h1>CERTIFICATE</h1>	
Quality Austria Trainings-, Zertifizierungs- und Begutachtungs GmbH awards this qualityaustria certificate to the following organisation:		This qualityaustria certificate confirms the application and further development of an effective	
METALAC FAD d.o.o. RS-32300 Gornji Milanovac, Kneza Aleksandra 210		QUALITY MANAGEMENT SYSTEM complying with the requirements of standard ISO 9001:2008	
Steering and suspension parts production		Registration No.: 08606/0 Date of initial issue: 25 November 2009 Valid until: 14 September 2018	
		Vienna, 28 October 2015	
<small>Quality Austria Trainings-, Zertifizierungs- und Begutachtungs GmbH is accredited according to the Austrian Accreditation Act by the BMM/FW (Federal Ministry of Science, Research and Economy). Quality Austria is accredited as an organisation for environmental verification by the BMA/FLW (Federal Ministry of Agriculture, Forestry, Environment and Water Management). Quality Austria is authorized by the VDA (Association of the Automotive Industry). For accreditation registration details please refer to the applicable decisions or recognition documents. Quality Austria is the Austrian member of IQNet (International Certification Network). Dok. Nr. FO_24_203 3bd93c84-210d-4a16-bd48-445633c03a84</small>		Quality Austria Trainings-, Zertifizierungs- und Begutachtungs GmbH, A-1010 Vienna, Zelinkagasse 10/3	
		 Konrad Scheiber General Manager	 Dr. Mag. Anni Koubek Specialist representative
		The current validity of the certificate is documented exclusively on the Internet under http://www.qualityaustria.com/en/cert EAC: 22.1	

SADRŽAJ

CONTENT

INHALT

AUTOBUSI / BUSES / BUSSE

OBJAŠNJENJE/EXPLANATION/ERKLÄRUNG	1
DAF	5
IVECO, IRISBUS, IRIZAR	7
KÄSSBOHRER	11
MAN	17
MERCEDES-BENZ	28
RENAULT	42
SCANIA	45
SOLARIS	50
VOLVO	52
CROSS. REF. OEM / FAD	59
CROSS. REF. FAD / OEM	71

UPUTSTVO

ERKLÄRUNG

EXPLANATION

Skica Benennung Description	Simbol Symbole Symbols	Objasnjenje Erklärung Explanation
<p>Spona upravljača Lenkstange Drag link</p>	<p>Kugla Ball Ø Größe</p> <p>ØR</p> <p>L</p> <p>K</p>	<p>-Precnik kugle Kugel-Durchmesser Ball pin diameter</p> <p>-Precnik cevi Rohr durchmesser Tube diameter</p> <p>-Duzina spona Längenmass von mitte bis mitte Distance center to center distance</p> <p>-Max. precnik konusa Größtmass am konus Taper Ø max. size</p>
<p>Poprecna spona Spurstange Tie rod</p>	<p>Kugla Ball Ø Größe</p> <p>ØR</p> <p>L</p> <p>K</p>	<p>-Precnik kugle Kugel-Durchmesser Ball pin diameter</p> <p>-Precnik cevi Rohr durchmesser Tube diameter</p> <p>-Duzina spona Längenmass von mitte bis mitte Distance center to center distance</p> <p>-Max. precnik konusa Größtmass am konus Taper Ø max. size</p>
<p>Zglob sa unutrašnjim navojem Kugelgelenk Tie rod end</p>	<p>Kugla Ball Ø Größe</p> <p>L</p> <p>K</p> <p>*</p>	<p>-Precnik kugle Kugel-Durchmesser Ball pin diameter</p> <p>-Duzina zgloba Kugelgelenk länge Tie rod end lenght</p> <p>-Max. precnik konusa Größtmass am konus Taper Ø max. size</p> <p>-Unutrašnji navoj Innengewinde Internal thread</p>

UPUTSTVO

ERKLÄRUNG

EXPLANATION

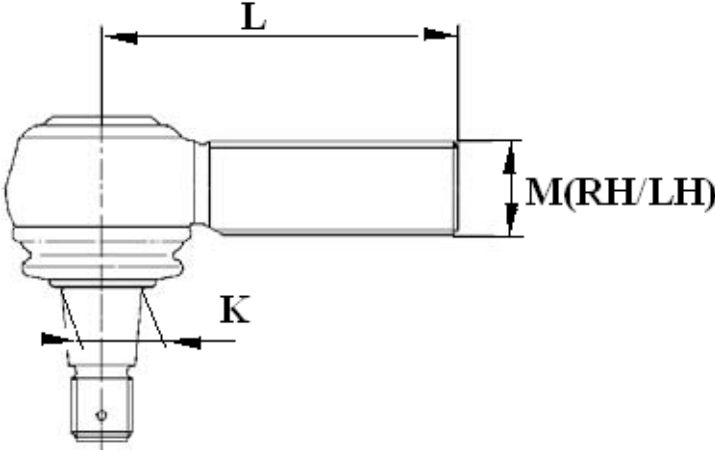
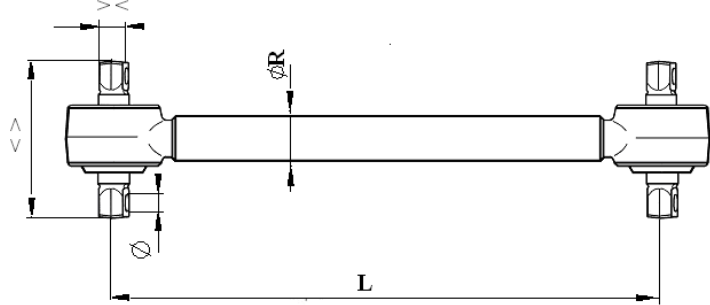
Skica Benennung Description	Simbol Symbole Symbols	Objasnjenje Erklärung Explanation
<p>Zglob Kugelgelenk Tie rod end</p> 	<p>Kugla Ball Ø Größe</p> <p>L</p> <p>K</p> <p>M</p> <p>RH</p> <p>LH</p>	<p>-Precnik kugle Kugel-Durchmesser Ball pin diameter</p> <p>-Duzina zgloba Kugelgelenk länge Tie rod end lenght</p> <p>-Max. precnik konusa Größtmass am konus Taper Ø max. size</p> <p>-Metricki navoj Metrisches gewinde ISO Thread-metrie</p> <p>-Desni navoj Rechtsgewinde Right hand thread</p> <p>-Levi navoj Linksgewinde Left hand thread</p>
<p>Vodjica mosta Achsstrebe Torque rod</p> 	<p>Kugla Ball Ø Größe</p> <p>ØR</p> <p>L</p> <p>Ø</p> <p>> <</p> <p>< ></p>	<p>-Precnik kugle Kugel-Durchmesser Ball pin diameter</p> <p>-Precnik cevi Rohr durchmesser Tube diameter</p> <p>-Duzina vodjice mosta Längenmass von mitte bis mitte Distance center to center distance</p> <p>-Precnik otvora Bohrungs-durchmesser Bore Ø</p> <p>-Debljina flaha Breite Broad</p> <p>-Rastojanje izmedju otvora Lochabstand Hole distance</p>

**UPUTSTVO
ERKLÄRUNG
EXPLANATION**

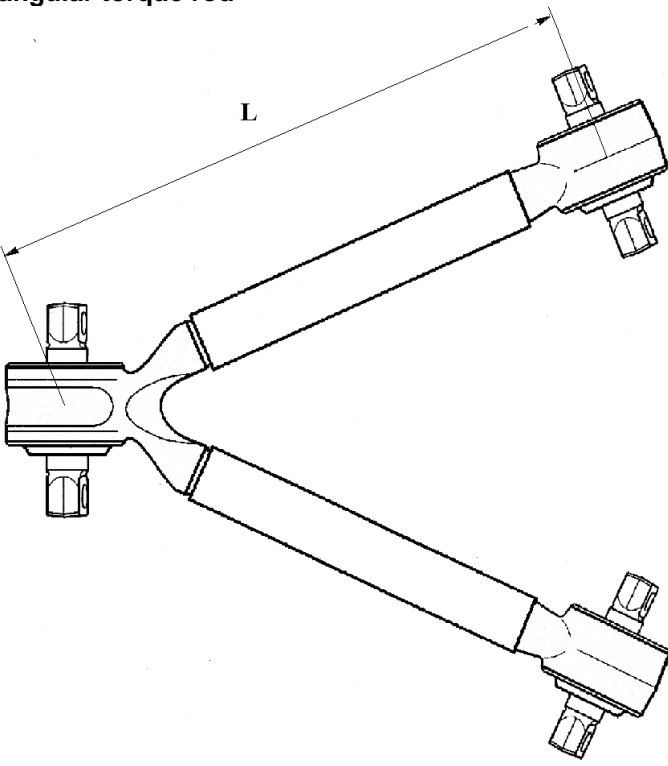
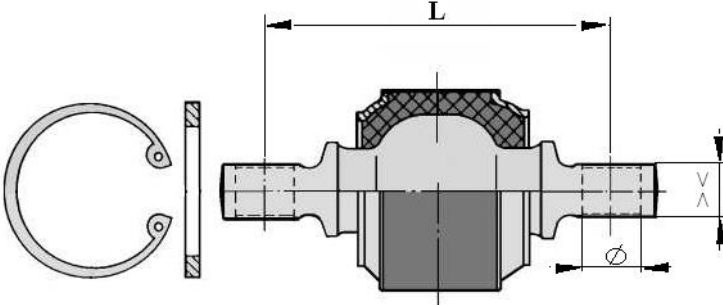
<p>Skica Benennung Description</p>	<p>Simbol Symbole Symbols</p>	<p>Objasnjenje Erklärung Explanation</p>
<p>V-vodjica mosta Dreieckslenker Triangular torque rod</p> 	<p>Kugla Ball Ø Größe</p> <p>ØR</p> <p>L</p> <p>Ø</p> <p>> <</p> <p>< ></p>	<p>-Precnik kugle Kugel-Durchmesser Ball pin diameter</p> <p>-Precnik cevi Rohr durchmesser Tube diameter</p> <p>-Duzina V-vodjice mosta Längenmass von mitte bis mitte Distance center to center distance</p> <p>-Precnik otvora Bohrungs-durchmesser Bore Ø</p> <p>-Debljina flaha Breite Broad</p> <p>-Rastojanje izmedju otvora Lochabstand Hole distance</p>
<p>Izmenljivi podsklop Rep.-satz, kugelstük, molekular Rep.-kit, with pivot pin, molecular</p> 	<p>Kugla Ball Ø Größe</p> <p>Ø</p> <p>> <</p> <p>< ></p>	<p>-Precnik kugle Kugel-Durchmesser Ball pin diameter</p> <p>-Precnik otvora Bohrungs-durchmesser Bore Ø</p> <p>-Debljina flaha Breite Broad</p> <p>-Rastojanje izmedju otvora Lochabstand Hole distance</p>

UPUTSTVO
ERKLÄRUNG
EXPLANATION

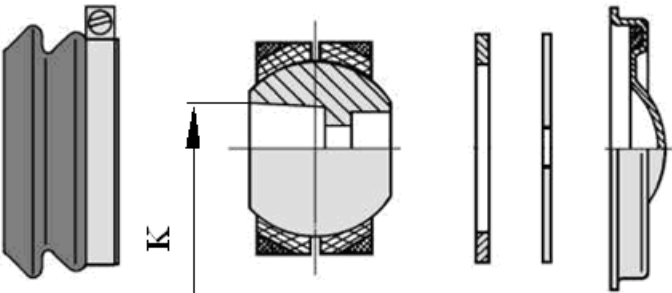
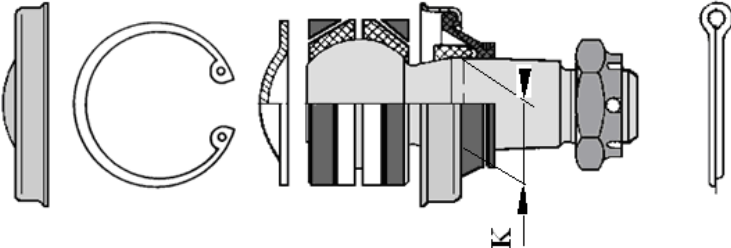

Skica Benennung Description	Simbol Symbole Symbols	Objasnjenje Erklärung Explanation
<p>Izmenljivi podsklop Rep.-satz, kugelhülse Rep.-kit, with ball housing</p> 	<p>Kugla Ball Ø Größe</p> <p>K</p>	<p>-Precnik kugle Kugel-Durchmesser Ball pin diameter</p> <p>-Max. precnik konusnog otvora Größtmass am innen-konus Taper hole Ø</p>
<p>Izmenljivi podsklop Rep.-satz, kugelzapfen Rep.-kit, with ball pin</p> 	<p>Kugla Ball Ø Größe</p> <p>K</p>	<p>-Precnik kugle Kugel-Durchmesser Ball pin diameter</p> <p>- Max. precnik konusa Größtmass am konus Taper Ø max. size</p>

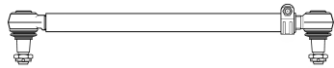
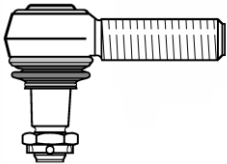
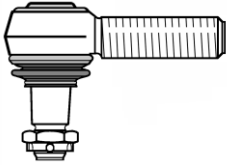
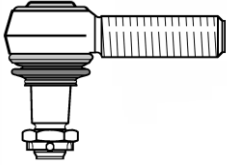
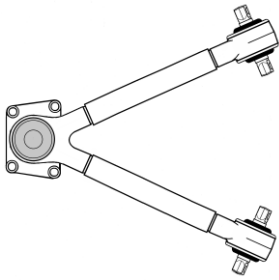

DAF

Originalni broj Cross-Ref.-No. Original Nr.	Br. FAD No. Nr.	Naziv Designation Bezeichnung	Kugla Ball Ø Größe	Konus Taper Konus	Dužina Length Länge	Skica Figure Bild
0 094 044 0 274 878 1 152 427	3889.00.00	Spona upravljača Drag link Lenkstange Izmenjivi delovi Parts list Stuckliste 5743.20.00	40	K30	1130 RØ40	
0 586 753 0 607 999 0 694 298 0 694 360 0 698 609 1 229 944 1 331 925	5741.20.00	Zglob, RH M30x1,5 Ball joint, RH Kugelgelenk, RH	35	K26	115	
0 607 981 0 698 450 1 149 907 1 152 350 1 257 890 1 603 789 1 618 048	5743.20.00	Zglob, RH M30x1,5 Ball joint, RH Kugelgelenk, RH	40	K30	120	
0 607 998 1 319 838	5741.10.00	Zglob, LH M30x1,5 Ball joint, LH Kugelgelenk, LH	35	K26	115	
0 649 819 1 620 437 1 793 877	3876.00.00	V Vođica mosta Triangular torque rod Dreieckslenker Izmenjivi delovi Parts list Stuckliste 5587.96.00 5943.90.00	80	Ø23 >35< <152>	604 RØ58	

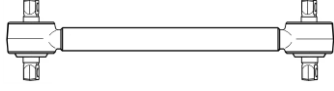
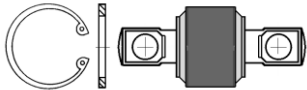
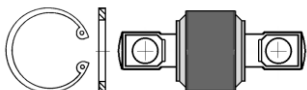
DAF

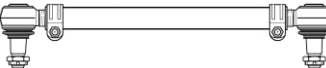

Originalni broj Cross-Ref.-No. Original Nr.	Br. FAD No. Nr.	Naziv Designation Bezeichnung	Kugla Ball Ø Größe	Konus Taper Konus	Dužina Length Länge	Skica Figure Bild
0 658 104 658 104	6772.00.00	Vodica mosta Torque rod Achsstrebe Izmenjivi delovi Parts list Stuckliste 5170.96.00	70	Ø19 >30< <130>	600 RØ50	
0 689 749	5170.96.00	Izmenjivi podsklop Repair kit Reparatur satz	70	Ø19 >30<	<130>	
0 696 321	5587.96.00	Izmenjivi podsklop Repair kit Reparatur satz	80	Ø23 >35<	<152>	
1 143 324 1 191 900	6781.00.00	Spona upravljača Drag link Lenkstange Izmenjivi delovi Parts list Stuckliste 5741.20.00	35	K26	1190 RØ40	
1 270 854 1 337 644	6817.00.00	Spona upravljača Drag link Lenkstange Izmenjivi delovi Parts list Stuckliste 5741.20.00 5741.10.00	35	K26	1734 RØ40	
1 290 321 1 353 394	6780.00.00	Poprečna spona Tie rod Spurstange Izmenjivi delovi Parts list Stuckliste 5741.10.00 5741.20.00	35	K26	1752 RØ40	

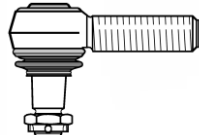
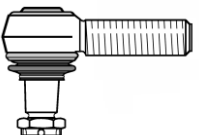
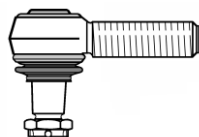
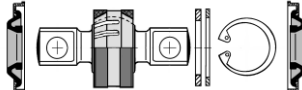
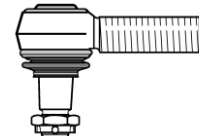
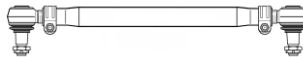
IVECO, IRISBUS, IRIZAR

Originalni broj Cross-Ref.-No. Original Nr.	Br. FAD No. Nr.	Naziv Designation Bezeichnung	Kugla Ball Ø Größe	Konus Taper Konus	Dužina Length Länge	Skica Figure Bild
296 6252 296 9808 4248 3386 4248 8269 4248 9573 4248 9594 4249 1638 480 2443 483 3829 812 2752	5743.20.00	Zglob, RH M30x1.5 Ball joint, RH Kugelgelenk, RH	40	K30	120	
298 0129 298 4511 4249 3782 483 3821 483 3826 483 3828 812 2755	5741.10.00	Zglob, LH M30x1.5 Ball joint, LH Kugelgelenk, LH	35	K26	115	
298 0323 309 6213 4248 3520 4249 3781 59 4989 0760	5741.20.00	Zglob, RH M30x1.5 Ball joint, RH Kugelgelenk, RH	35	K26	115	
298 0884	5959.90.00	Izmenjivi podsklop Repair kit Reparatur satz	65	Ø19 >30<	<130>	
298 4061 4248 9395 4248 9574 4249 1957 480 2444 483 3830 819 0225	5743.10.00	Zglob, LH M30x1.5 Ball joint, LH Kugelgelenk, LH	40	K30	120	
4100 5450 4100 5451 4103 6944 4104 2730 816 3773	6439.00.00	Poprečna spona Tie rod Spurstange Izmenjivi delovi Parts list Stuckliste 5743.10.00 5743.20.00	40	K30	1641 RØ50	



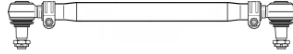
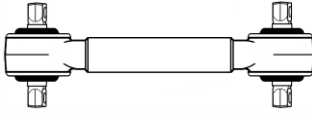
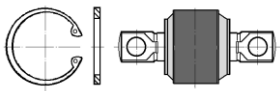
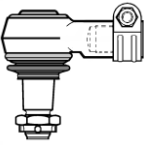
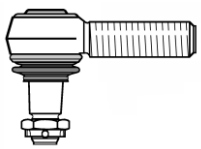



IVECO, IRISBUS, IRIZAR

Originalni broj Cross-Ref.-No. Original Nr.	Br. FAD No. No. Nr.	Naziv Designation Bezeichnung	Kugla Ball Ø Größe	Konus Taper Konus	Dužina Length Länge	Skica Figure Bild
4103 6943	6418.00.00	Poprečna spona Tie rod Spurstange Izmenjivi delovi Parts list Stuckliste 5743.10.00 5743.20.00	40	K30	1620 RØ50	
4212 5057 471 4134 9848 8010	5114.00.00	Vodica mosta Torque rod Achsstrebe Izmenjivi delovi Parts list Stuckliste 5959.90.00	65	Ø19 >30< <130>	580 RØ50	
4248 8722	5170.96.00	Izmenjivi podsklop Repair kit Reparatur satz	70	Ø19 >30<	<130>	
4253 3101 4253 3102	6425.20.00	Zglob, RH M26x1.5 * Ball joint, RH Kugelgelenk, RH	40	K30	80	
468 8941 716 7757 856 5366 858 2332	5122.20.00	Zglob, RH M28x1.5 Ball joint, RH Kugelgelenk, RH	35	K26	115	
477 3359 483 4037	5122.00.00	Spona upravljača Drag link Lenkstange Izmenjivi delovi Parts list Stuckliste 5122.20.00	35	K26	975 RØ36	

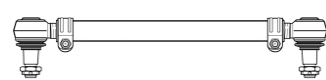
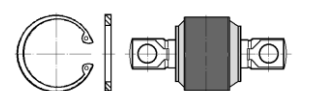

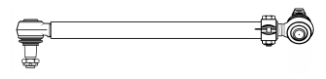

IVECO, IRISBUS, IRIZAR



Originalni broj Cross-Ref.-No. Original Nr.	Br. FAD No. Nr.	Naziv Designation Bezeichnung	Kugla Ball Ø Größe	Konus Taper Konus	Dužina Length Länge	Skica Figure Bild
485 4871	6404.00.00	Poprečna spona Tie rod Spurstange Izmenjivi delovi Parts list Stuckliste 5741.10.00 5741.20.00	35	K26	1584 RØ40	
500 307 556 9840 2553	6402.00.00	Poprečna spona Tie rod Spurstange Izmenjivi delovi Parts list Stuckliste 5741.10.00 5741.20.00	35	K26	1490 RØ40	
500 333 284	4569.96.00	Izmenjivi podsklop Repair kit Reparatur satz	62	Ø19 >24<	<130>	
500 336 085 9945 5009	6433.00.00	Spona upravljača Drag link Lenkstange Izmenjivi delovi Parts list Stuckliste 4681.20.00	40	K30	883 RØ52	
504 113 824	6446.00.00	Spona upravljača Drag link Lenkstange Izmenjivi delovi Parts list Stuckliste 4126.20.00	40	K30	529 RØ50	
504 113 827 5801 890 971	6445.00.00	Poprečna spona Tie rod Spurstange Izmenjivi delovi Parts list Stuckliste 5743.10.00 5743.20.00	40	K30	470 RØ40	

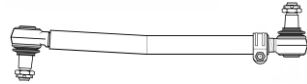
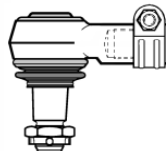
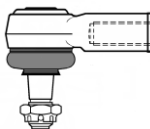
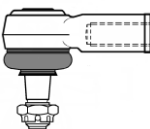
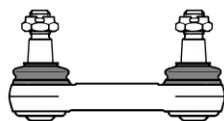
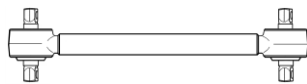

IVECO, IRISBUS, IRIZAR

Originalni broj Cross-Ref.-No. Original Nr.	Br. FAD No. Nr.	Naziv Designation Bezeichnung	Kugla Ball Ø Größe	Konus Taper Konus	Dužina Length Länge	Skica Figure Bild
857 0528	5148.00.00	Spona upravljača Drag link Lenkstange Izmenjivi delovi Parts list Stuckliste 5741.20.00	35	K26	690 RØ40	
9319 2809	6426.20.00	Zglob, RH M30x1.5* Ball joint, RH Kugelgelenk, RH	40	K30	80	
9380 0662 9380 4059	1480.20.00	Zglob, RH M16x1.5* Ball joint, RH Kugelgelenk, RH	25	K18	80	
9380 2209 9380 4060	1481.20.00	Zglob, RH M20x1.5* Ball joint, RH Kugelgelenk, RH	35	K24	72	
9848 4091	6395.00.00	Stabilizator Stabilizer link Koppelstang	35	K26	100 RØ32	
9848 8010	5103.00.00	Vodica mosta Torque rod Achsstrebe Izmenjivi delovi Parts list Stuckliste 5170.96.00	70	Ø19 >30< <130>	583 RØ50	
9944 4744 9948 7779	6344.00.00	Vodica mosta Torque rod Achsstrebe Izmenjivi delovi Parts list Stuckliste 5117.96.00	62	Ø19 >24< <130>	644 RØ50	

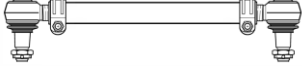

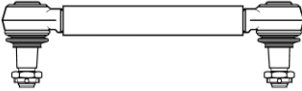
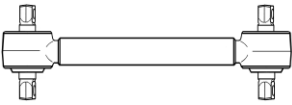
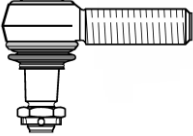
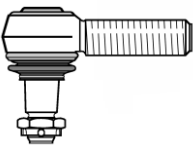

KÄSSBOHRER

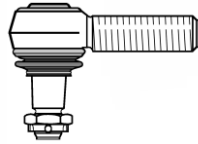
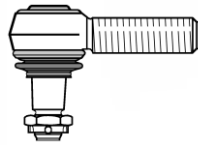
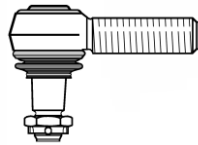
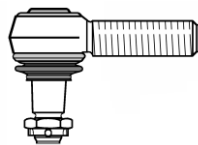
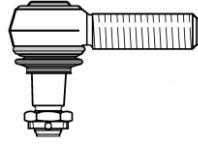
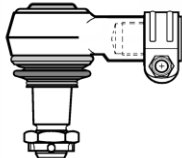
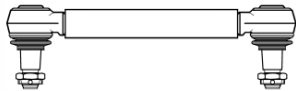
Originalni broj Cross-Ref.-No. Original Nr.	Br. FAD No. Nr.	Naziv Designation Bezeichnung	Kugla Ball Ø Größe	Konus Taper Konus	Dužina Length Länge	Skica Figure Bild
628 330 04 03 628 330 05 03	6909.00.00	Poprečna spona Tie rod Spurstange Izmenljivi delovi Parts list Stuckliste 5741.10.00 5741.20.00	35	K26	768 RØ40	
6.284.600.305	4576.00.00	Spona upravljača Drag link Lenkstange	40	K30	928 RØ42	
628 460 20 05	4595.00.00	Poprečna spona Tie rod Spurstange	40	K30	566 RØ36	
6.293.500.606 8.226.293.000B	6197.00.00	Vođica mosta Torque rod Achsstrebe Izmenljivi delovi Parts list Stuck liste 5170.96.00	70	Ø19 >30< <130>	658 RØ50	
6.851.446.000 6.851.459.000 6.851.479.000 6.851.487.000 6.851.532.000	5742.10.00	Zglob,LH M30x1,5 Ball joint, LH Kugelgelenk, LH	40	K26	120	
6.851.447.000 6.851.478.000 6.851.486.000 6.851.488.000 6.851.523.000	5742.20.00	Zglob,RH M30x1,5 Ball joint, RH Kugelgelenk, RH	40	K26	120	

KÄSSBOHRER

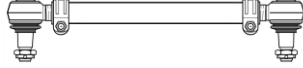
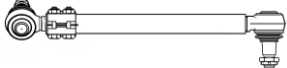

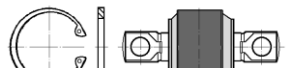
Originalni broj Cross-Ref.-No. Original Nr.	Br. FAD No. Nr.	Naziv Designation Bezeichnung	Kugla Ball Ø Größe	Konus Taper Konus	Dužina Length Länge	Skica Figure Bild
6.851.475.000 6.851.480.000 6.851.484.000 6.851.531.000 8.226.236.059	5743.20.00	Zglob,RH M30x1,5 Ball joint, RH Kugelgelenk, RH	40	K30	120	
6.851.485.000 8.226.236.058	5743.10.00	Zglob,LH M30x1,5 Ball joint, LH Kugelgelenk, LH	40	K30	120	
6.851.490.000	3581.10.00	Zglob,LH M38x1,5 Ball joint, LH Kugelgelenk, LH	50	K38	135	
6.851.491.000	3581.20.00	Zglob,RH M38x1,5 Ball joint, RH Kugelgelenk, RH	50	K38	135	
6.851.517.000	5741.20.00	Zglob,RH M30x1,5 Ball joint, RH Kugelgelenk, RH	35	K26	115	
6.851.529.000	4911.20.00	Zglob,RHM30x1.5* Ball joint,RH Kugelgelenk,RH	40	K30	120	
8.226.137.000 8.226.147.000C 8.226.305.000C 8.226.313.000C	5686.00.00	Spona upravljača Drag link Lenkstange	35	K26	380 RØ40	

KÄSSBOHRER

Originalni broj Cross-Ref.-No. Original Nr.	Br. FAD No. Nr.	Naziv Designation Bezeichnung	Kugla Ball Ø Größe	Konus Taper Konus	Dužina Length Länge	Skica Figure Bild
8.226.138.000 8.226.148.000C	5687.00.00	Spona upravljača Drag link Lenkstange Izmenljivi delovi Parts list Stuckliste 5742.20.00 5742.10.00	40	K26	655 RØ50	
8.226.225.000D	6045.00.00	Poprečna spona Tie rod Spurstange Izmenljivi delovi Part list Stuckliste 3581.20.00	50	K38	647 RØ50	
8.226.232.000 8.226.241.000 8.226.357.000	3491.00.00	Vođica mosta Torque rod Achsstrebe Izmenljivi delovi Parts list Stuck liste 5170.96.00	70	Ø19 >30< <130>	660 RØ50	
8.226.232.066.0	5170.96.00	Izmenljivi podsklop Repair kit Reparatur satz	70	Ø19 >30<	<130>	
8.226.238.000C	6048.00.00	Spona upravljača Drag link Lenkstange Izmenljivi delovi Part list Stuckliste 5743.20.00 5743.10.00	40	K30	1660 RØ50	

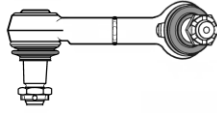
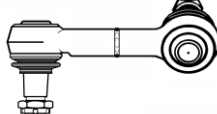
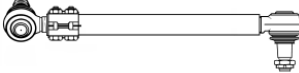

KÄSSBOHRER

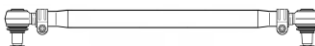
Originalni broj Cross-Ref.-No. Original Nr.	Br. FAD No. No. Nr.	Naziv Designation Bezeichnung	Kugla Ball Ø Größe	Konus Taper Konus	Dužina Length Länge	Skica Figure Bild
8.226.249.000C	6040.00.00	Stabilizator Stabillizer link Koppelstang	40	K30	148 RØ32	
8.226.250.0000 8.226.250.000C	6041.00.00	Stabilizator Stabillizer link Koppelstang	40	K30	148 RØ32	
8.226.257.000	6042.00.00	Spona upravljača Drag link Lenkstange Izmenljivi delovi Parts list Stuckliste 3581.20.00	50	K38	910 RØ50	
8.226.259.000 8.226.262.000 8.226.259.000C 8.226.262.000C	3494.00.00	Spona upravljača Drag link Lenkstange Izmenljivi delovi Parts list Stuckliste 5743.20.00 5743.10.00	40	K30	2165 RØ50	
8.226.261.000C	6043.00.00	Spona upravljača Drag link Lenkstange Izmenljivi delovi Parts list Stuckliste 5743.20.00 5743.10.00	40	K30	1585 RØ50	
8.226.280.000B 8.226.280.000C 8.226.280.0000 8.226.355.000 8.226.355.0000	4920.00.00	Spona upravljača Drag link Lenkstange Izmenljivi delovi Parts list Stuckliste 4563.20.00 6321.10.00	40	K30	2175 RØ50	

KÄSSBOHRER

Originalni broj Cross-Ref.-No. Original Nr.	Br. FAD No. No. Nr.	Naziv Designation Bezeichnung	Kugla Ball Ø Größe	Konus Taper Konus	Dužina Length Länge	Skica Figure Bild
8.226.306.000 8.226.244.000D 8.226.258.000C	3492.00.00	Poprečna spona Tie rod Spurstange Izmenljivi delovi Parts list Stuckliste 5742.20.00 5742.10.00	40	K26	670 RØ40	
8.226.307.000 8.226.347.000 8.226.247.000C	6049.00.00	Poprečna spona Tie rod Spurstange	40	K30	484 RØ40	
8.226.308.000 8.226.308.000C 8.226.248.000C 8.226.381.000	4911.00.00	Poprečna spona Tie rod Spurstange Izmenljivi delovi Part list Stuckliste 4911.20.00	40	K30	630 RØ40	
8.226.318.000B 8.226.323.000B	3497.00.00	Vođica mosta Torque rod Achsstrebe Izmenljivi delovi Parts list Stuckliste 5170.96.00	70	Ø19 >30< <130>	660 RØ50	
8.226.328.000	4912.00.00	Poprečna spona Tie rod Spurstange Izmenljivi delovi Part list Stuckliste 4911.20.00	40	K30	680 RØ40	

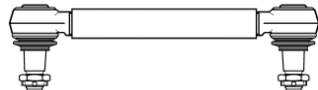
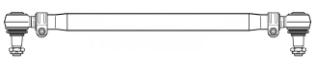
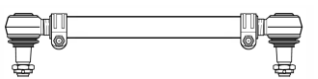
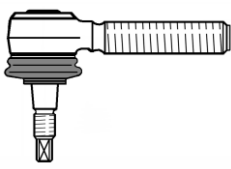
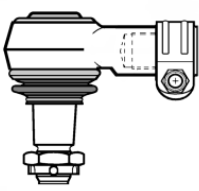

KÄSSBOHRER

Originalni broj Cross-Ref.-No. Original Nr.	Br. FAD No. No. Nr.	Naziv Designation Bezeichnung	Kugla Ball Ø Größe	Konus Taper Konus	Dužina Length Länge	Skica Figure Bild
8.226.330.000	4915.00.00	Poprečna spona Tie rod Spurstange	40	K30	380 RØ40	
8.226.356.000	4913.00.00	Poprečna spona Tie rod Spurstange Izmenljivi delovi Parts list Stuckliste 5743.20.00 5743.10.00	40	K30	2130 RØ50	
8.226.380.000 8.226.380.000C	4914.00.00	Spona upravljača Drag link Lenkstange Izmenljivi delovi Parts list Stuckliste 5855.20.00 5743.10.00	40	K32 K30	870 RØ40	
8.321.999.319	3590.20.00	Zglob, RH M14x1.5 Ball joint, RH Kugelgelenk, RH	22	K12	85	
8.851.360.000	7476.20.00	Zglob, RHM30x1.5 * Ball joint, RH Kugelgelenk, RH	40	K26	120	

MAN

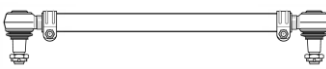
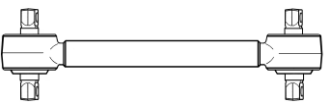
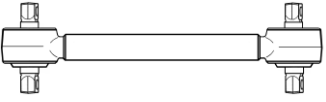
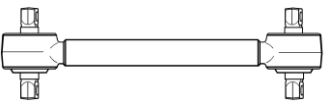
Originalni broj Cross-Ref.-No. Original Nr.	Br. FAD No. Nr.	Naziv Designation Bezeichnung	Kugla Ball Ø Größe	Konus Taper Konus	Dužina Length Länge	Skica Figure Bild
36 46610 6000	6699.00.00	Poprečna spona Tie rod Spurstange Izmenjivi delovi Parts list Stuckliste 6321.10.00 4563.20.00	40	K30	300 RØ40	
36 46710 6003 36 46710 6005	6698.00.00	Poprečna spona Tie rod Spurstange Izmenjivi delovi Parts list Stuckliste 6321.10.00 4563.20.00	40	K30	753 RØ42	
81 43220 6025	5948.00.00	Vođica mosta Torque rod Achsstrebe Izmenjivi delovi Parts list Stuckliste 5170.96.00	70	Ø19 >30< <130>	455 RØ50	
81 43220 6042	5951.00.00	Vođica mosta Torque rod Achsstrebe Izmenjivi delovi Parts list Stuckliste 5170.96.00	70	Ø19 >30< <130>	762 RØ50	
81 43220 6043	5952.00.00	Vođica mosta Torque rod Achsstrebe Izmenjivi delovi Parts list Stuckliste 5170.96.00	70	Ø19 >30< <130>	661 RØ50	



MAN

Originalni broj Cross-Ref.-No. Original Nr.	Br. FAD No. Nr.	Naziv Designation Bezeichnung	Kugla Ball Ø Größe	Konus Taper Konus	Dužina Length Länge	Skica Figure Bild
81 43220 6055 81 43220 6073	5170.96.00	Izmenjivi podsklop Repair kit Reparatur satz	70	Ø19 >30<	<130>	
81 43220 6099 81 43220 6100	5956.00.00	Vođica mosta Torque rod Achsstrebe Izmenjivi delovi Parts list Stuckliste 5170.96.00	70	Ø19 >30< <130>	750 RØ50	
81 43220 6102 81 43220 6148 81 43220 6152 81 43220 6186	5538.00.00	Vođica mosta Torque rod Achsstrebe Izmenjivi delovi Parts list Stuckliste 5170.96.00	70	Ø19 >30< <130>	670 RØ50	
81 43220 6108	5959.90.00	Izmenjivi podsklop Repair kit Reparatur satz	65	Ø19 >30<	<130>	
81 43220 6144 81 43220 6189 81 43220 6210 81 43220 6211 81 43220 6396 81 43220 6409	4107.00.00	Vođica mosta Torque rod Achsstrebe Izmenjivi delovi Parts list Stuckliste 5170.96.00	70	Ø19 >30< <130>	614 RØ50	
81 43220 6151 81 43220 6183 81 43220 6276 81 43220 6277 81 43220 6390	6194.00.00	Vođica mosta Torque rod Achsstrebe Izmenjivi delovi Parts list Stuckliste 5942.96.00	70	Ø19 >24< <130>	570 RØ50	

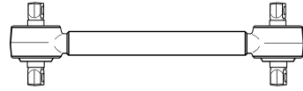
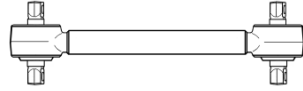
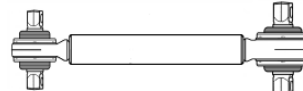
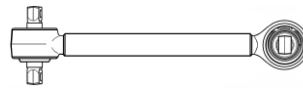
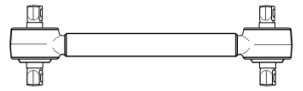
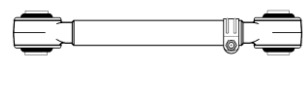
MAN**FAD**

Originalni broj Cross-Ref.-No. Original Nr.	Br. FAD No. Nr.	Naziv Designation Bezeichnung	Kugla Ball Ø Größe	Konus Taper Konus	Dužina Length Länge	Skica Figure Bild
81 43220 6161 81 43220 6190 81 43220 6397	4108.00.00	Vođica mosta Torque rod Achsstrebe Izmenjivi delovi Parts list Stuckliste 5170.96.00	70	Ø19 >30< <130>	531 RØ50	
81 43220 6168	5339.00.00	Vođica mosta Torque rod Achsstrebe Izmenjivi delovi Parts list Stuckliste 3935.96.00	55	Ø17 >20< <100>	570 RØ40	
81 43220 6174	6191.00.00	Vođica mosta Torque rod Achsstrebe Izmenjivi delovi Parts list Stuckliste 5959.90.00	65/40	Ø19/ Ø18.5 >30</ >24< <130>/ <102>	644 RØ50	
81 43220 6258 81 43220 6264 81 43220 6275 81 43220 6278 81 43220 6279 81 43220 6391	6683.00.00	Vođica mosta Torque rod Achsstrebe Izmenjivi delovi Parts list Stuckliste 5942.96.00	70	Ø19 >24< <130>	622 RØ50	
81 43230 6037 81 43230 9037	5537.00.00	Vođica mosta Torque rod Achsstrebe Izmenjivi delovi Parts list Stuckliste 5170.96.00	70	Ø19 >30< <130>	500 RØ50	
81 43250 6011 81 43250 6016	4137.00.00	Vođica mosta Torque rod Achsstrebe	40	Ø20	880 RØ40	

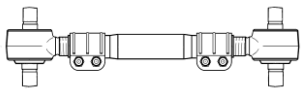
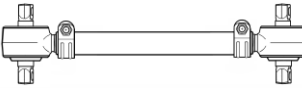
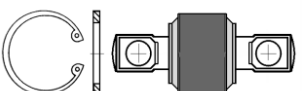
MAN







Originalni broj Cross-Ref.-No. Original Nr.	Br. FAD No. Nr.	Naziv Designation Bezeichnung	Kugla Ball Ø Größe	Konus Taper Konus	Dužina Length Länge	Skica Figure Bild
81 43315 6012	5535.00.00	Vođica mosta Torque rod Achsstrebe Izmenjivi delovi Parts list Stuckliste 5535.10.00 5535.20.00	78.5	Ø34	652 RØ50	
81 43718 6006 81 43718 6007	5522.00.00	Vođica mosta Torque rod Achsstrebe Izmenjivi delovi Parts list Stuckliste 5522.96.00	45	Ø15 >20< <90>	464 RØ40	
81 43718 6009	5522.96.00	Izmenjivi podsklop Repair kit Reparatur satz	45	Ø15 >20<	<90>	
81 46610 6147 81 46610 6194 81 46610 6195 81 46610 6201 81 46610 6257 81 46610 6415 81 46610 6476 81 46610 6503 81 46610 6532 81 46610 6608 81 46610 6630	5946.00.00	Spona upravljajača Drag link Lenkstange Izmenjivi delovi Parts list Stuckliste 5743.10.00 5743.20.00	40	K30	1853 RØ52	
81 46610 6196 81 46610 6202 81 46610 6258 81 46610 6409 81 46610 6504 81 46610 6531 81 46610 6593 81 46610 6609 81 46610 6631 81 46610 6740	5932.00.00	Spona upravljajača Drag link Lenkstange Izmenjivi delovi Parts list Stuckliste 5743.10.00 5743.20.00	40	K30	1953 RØ52	







MAN

Originalni broj Cross-Ref.-No. Original Nr.	Br. FAD No. Nr.	Naziv Designation Bezeichnung	Kugla Ball Ø Größe	Konus Taper Konus	Dužina Length Länge	Skica Figure Bild
81 46610 6292 81 46610 6424 81 46610 6432 81 46610 6434 81 46610 6437 81 46610 6513 81 46610 6537 81 46610 6596 81 46610 6614 81 46610 6635 81 46610 6735 81 46610 6743 81 46611 6051 81 46611 6052	5235.00.00	Spona upravljača Drag link Lenkstange Izmenjivi delovi Parts list Stuckliste 5743.10.00 5743.20.00	40	K30	1922 RØ50	
81 46610 6374 81 46611 6019 82 46610 6080 82 46610 6089 82 46610 6090	5975.00.00	Spona upravljača Drag link Lenkstange Izmenjivi delovi Parts list Stuckliste 5743.10.00 5743.20.00	40	K30	1050 RØ42	
81 46610 6376	6206.00.00	Spona upravljača Drag link Lenkstange Izmenjivi delovi Parts list Stuckliste 5743.20.00	40	K30	1400 RØ40	
81 46610 6548 81 46611 6065	6691.00.00	Spona upravljača Drag link Lenkstange Izmenjivi delovi Parts list Stuckliste 5743.20.00	40	K30	610 RØ40	
81 46610 6606	4097.00.00	Spona upravljača Drag link Lenkstange Izmenjivi delovi Parts list Stuckliste 4563.20.00	40	K30	1270 RØ50	

MAN

Originalni broj Cross-Ref.-No. Original Nr.	Br. FAD No. Nr.	Naziv Designation Bezeichnung	Kugla Ball Ø Größe	Konus Taper Konus	Dužina Length Länge	Skica Figure Bild
81 46610 6648 81 46611 6150	6681.00.00	Spona upravljača Drag link Lenkstange Izmenjivi delovi Parts list Stuckliste 5743.20.00	40	K30	1145 RØ50	
81 46610 6689 81 46610 6720 81 46610 6721	6203.00.00	Poprečna spona Tie rod Spurstange Izmenjivi delovi Parts list Stuckliste 5743.10.00 5743.20.00	40	K30	1406 RØ50	
81 46610 6708 81 46611 6067	6198.00.00	Spona upravljača Drag link Lenkstange Izmenjivi delovi Parts list Stuckliste 5743.20.00	40	K30	905 RØ52	
81 46610 6716 81 46611 6068	6202.00.00	Spona upravljača Drag link Lenkstange Izmenjivi delovi Parts list Stuckliste 5743.20.00	40	K30	745 RØ50	
81 46610 6756	6211.00.00	Spona upravljača Drag link Lenkstange	40	K30	921 RØ60	
81 46610 6795 81 46611 6045 81 46611 6047 81 46611 6049 81 46611 6115 81 46611 6126	6689.00.00	Poprečna spona Tie rod Spurstange	40	K30	628 RØ40	

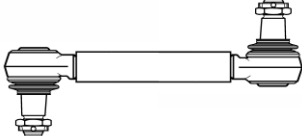
MAN

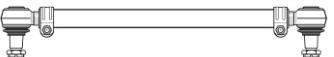





Originalni broj Cross-Ref.-No. Original Nr.	Br. FAD No. Nr.	Naziv Designation Bezeichnung	Kugla Ball Ø Größe	Konus Taper Konus	Dužina Length Länge	Skica Figure Bild
81 46610 6803	6325.00.00	Spona upravljača Drag link Lenkstange Izmenjivi delovi Parts list Stuckliste 5741.20.00	35	K26	1340 RØ40	
81 46611 6108 81 46611 6120 81 46611 6125 81 46611 6129	6688.00.00	Poprečna spona Tie rod Spurstange Izmenjivi delovi Parts list Stuckliste 4126.20.00	40	K30	1358 RØ52	
81 46611 6131	6687.00.00	Spona upravljača Drag link Lenkstange	35	K26	745 RØ40	
81 46611 6217 83 46610 6001 83 46610 6501	6252.00.00	Spona upravljača Drag link Lenkstange Izmenjivi delovi Parts list Stuckliste 6252.20.00	40	K30	1103 RØ50	
81 46710 6080 81 46710 6136 81 46710 6172 81 46710 6295 81 46710 6337 81 46710 6345 81 46710 6421 81 46710 6451 81 46710 6876 81 46710 6882 81 46711 6763 81 46711 6764	5933.00.00	Poprečna spona Tie rod Spurstange Izmenjivi delovi Parts list Stuckliste 5743.10.00 5743.20.00	40	K30	501 RØ40	

MAN

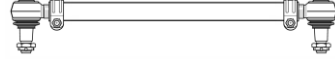

Originalni broj Cross-Ref.-No. Original Nr.	Br. FAD No. Nr.	Naziv Designation Bezeichnung	Kugla Ball Ø Größe	Konus Taper Konus	Dužina Length Länge	Skica Figure Bild
81 46710 6081 81 46710 6137 81 46710 6173 81 46710 6294 81 46710 6419 81 46710 6444 81 46710 6761 81 46710 6877 81 46710 6879 81 46711 6759 81 46711 6760 81 46711 6761	5934.00.00	Poprečna spona Tie rod Spurstange	40	K30	729 RØ40	
81 46710 6117 81 46710 6281 81 46710 6282 81 46710 6370 81 46710 6371 81 46710 6372	4104.00.00	Poprečna spona Tie rod Spurstange Izmenjivi delovi Parts list Stuckliste 5741.10.00 5741.20.00	35	K26	1605 RØ36	
81 46710 6122 81 46710 6167 81 46710 6194 81 46710 6195 81 46710 6378 81 46710 6379 81 46710 6380 81 46710 6830 81 46710 6836 81 46710 6911 81 46710 6912 81 46710 6953 81 46711 6736 81 46711 6747 81 46711 6830	4134.00.00	Poprečna spona Tie rod Spurstange Izmenjivi delovi Parts list Stuckliste 5743.20.00	40	K30	1588 RØ52	
81 46710 6175 81 46710 6242 81 46710 6251 81 46710 6420	3777.00.00	Poprečna spona Tie rod Spurstange	40	K30	786 RØ40	

MAN**FAD**

Originalni broj Cross-Ref.-No. Original Nr.	Br. FAD No. No. Nr.	Naziv Designation Bezeichnung	Kugla Ball Ø Größe	Konus Taper Konus	Dužina Length Länge	Skica Figure Bild
81 46710 6176 81 46710 6340 81 46710 6344 81 46710 6422	3776.00.00	Poprečna spona Tie rod Spurstange Izmenjivi delovi Parts list Stuckliste 5743.10.00 5743.20.00	40	K30	399 RØ40	
81 46710 6236 81 46710 6267 81 46710 6268 81 46710 6355 81 46710 6356 81 46710 6373 81 46711 6723	5210.00.00	Poprečna spona Tie rod Spurstange Izmenjivi delovi Parts list Stuckliste 5743.10.00 5743.20.00	40	K30	1692 RØ50	
81 46710 6453 81 46710 6457 81 46710 6458 81 46710 6875 81 46710 6881 81 46711 6765 81 46711 6766 81 46711 6767	4123.00.00	Poprečna spona Tie rod Spurstange	40	K30	699 RØ40	
81 46710 6459 81 46710 6806 81 46710 6818 81 46710 6819 81 46710 6908	5976.00.00	Poprečna spona Tie rod Spurstange Izmenjivi delovi Parts list Stuckliste 4126.20.00	35	K26	1725 RØ50	
81 46710 6862 81 46710 6863 81 46710 6864 81 46710 6909 81 46710 6910 81 46710 6974 81 46711 6712 81 46711 6845	6792.00.00	Poprečna spona Tie rod Spurstange Izmenjivi delovi Parts list Stuckliste 6791.20.00	35	K26	1698 RØ50	

MAN

Originalni broj Cross-Ref.-No. Original Nr.	Br. FAD No. No. Nr.	Naziv Designation Bezeichnung	Kugla Ball Ø Größe	Konus Taper Konus	Dužina Length Länge	Skica Figure Bild
81 46711 6711 81 46711 6785 81 46711 6846	4132.00.00	Poprečna spona Tie rod Spurstange Izmenjivi delovi Parts list Stuckliste 6791.20.00	35	K26	1650 RØ50	
81 46711 6715 81 46711 6823 81 46711 6842 81 46711 6958	6791.00.00	Poprečna spona Tie rod Spurstange Izmenjivi delovi Parts list Stuckliste 4133.20.00	40	K30	1700 RØ52	
81 46711 6727 81 46711 6732 81 46711 6778 81 46711 6844	6193.00.00	Poprečna spona Tie rod Spurstange Izmenjivi delovi Parts list Stuckliste 5743.20.00	40	K30	1729 RØ50	
81 46711 6770 81 46711 6772 81 46711 6782 81 46711 6783 81 46711 6874 81 46711 6875 81 46711 6876	4096.00.00	Poprečna spona Tie rod Spurstange Izmenjivi delovi Parts list Stuckliste 5743.10.00 5743.20.00	40	K30	661 RØ40	
81 46711 6771 81 46711 6780 81 46711 6877 81 46711 6878 81 46711 6879	4147.00.00	Poprečna spona Tie rod Spurstange	40	K30	413 RØ36	
81 95301 0013 81 95301 0074 81 95301 6068 81 95301 6163 81 95301 6361 90 80415 3107 90 80415 3113	5741.10.00	Zglob, LH M30x1.5 Ball joint, LH Kugelgelenk, LH	35	K26	115	

MAN
FAD

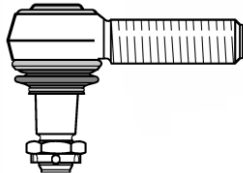
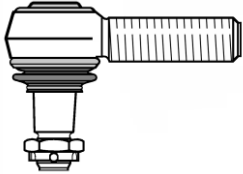
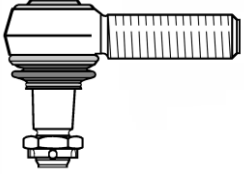
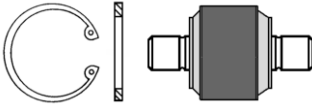
Originalni broj Cross-Ref.-No. Original Nr.	Br. FAD No. No. Nr.	Naziv Designation Bezeichnung	Kugla Ball Ø Größe	Konus Taper Konus	Dužina Length Länge	Skica Figure Bild
81 95301 0014 81 95301 0064 81 95301 6067 81 95301 6162 81 95301 6239 81 95301 6360 90 80415 3111	5741.20.00	Zglob, RH M30x1.5 Ball joint, RH Kugelgelenk, RH	35	K26	115	
81 95301 0015 81 95301 0083 81 95301 0087 81 95301 6030 81 95301 6043 81 95301 6050 81 95301 6054 81 95301 6087 81 95301 6091 81 95301 6155 81 95301 6168 81 95301 6179 81 95301 6237 81 95301 6279	5743.10.00	Zglob, LH M30x1.5 Ball joint, LH Kugelgelenk, LH	40	K30	120	
81 95301 0016 81 95301 0084 81 95301 6048 81 95301 6049 81 95301 6053 81 95301 6090 81 95301 6108 81 95301 6112 81 95301 6126 81 95301 6143 81 95301 6149 81 95301 6154 81 95301 6156 81 95301 6178 81 95301 6194 81 95301 6224 81 95301 6234 81 95301 6274	5743.20.00	Zglob, RH M30x1.5 Ball joint, RH Kugelgelenk, RH	40	K30	120	
81 95302 0039	5535.96.00	Izmenjivi podsklop Repair kit Reparatur satz	78.5	Ø16.5 >34<		

MERCEDES-BENZ

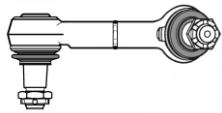
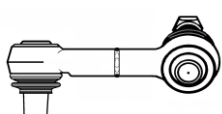
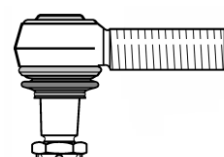
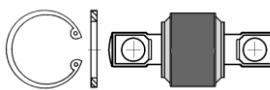
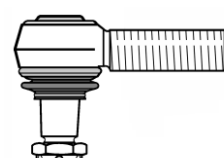
Originalni broj Cross-Ref.-No. Original Nr.	Br. FAD No. Nr.	Naziv Designation Bezeichnung	Kugla Ball Ø Größe	Konus Taper Konus	Dužina Length Länge	Skica Figure Bild
000 320 01 32 000 320 05 32 000 320 08 32 000 320 11 32 632 320 03 32	6890.00.00	Stabilizator Stabilizer link Koppelstang	40	K30	148 RØ32	
000 320 02 32 000 320 06 32 000 320 09 32 000 320 10 32 632 320 04 32	6889.00.00	Stabilizator Stabilizer link Koppelstang	40	K30	148 RØ32	
000 330 00 35 000 330 01 48 001 460 40 48 001 460 43 48 001 460 64 48 002 460 02 48 302 330 00 35 302 330 01 35 302 330 02 35 302 330 03 35 350 330 71 35	5741.10.00	Zglob,LH M30x1.5 Ball joint, LH Kugelgelenk, LH	35	K26	115	
000 330 00 75	3310.96.00	Izmenljivi podsklop Repair kit Reparatur satz	70	Ø16 >30<	<130>	
000 330 02 48 000 330 32 35 000 338 34 10 000 460 83 48 000 463 34 29 001 330 01 35 001 330 02 35 001 330 67 35 001 460 41 48 001 460 44 48 001 460 63 48 001 460 83 48 001 460 84 48 001 460 97 48 002 330 15 35	5741.20.00	Zglob,RH M30x1.5 Ball joint, RH Kugelgelenk, RH	35	K26	115	

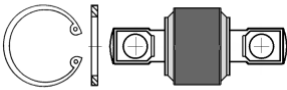
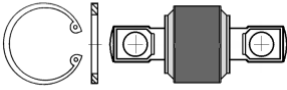
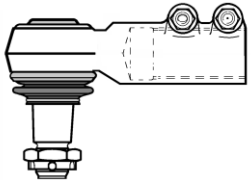
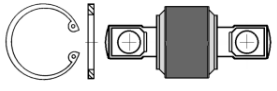
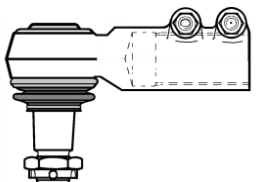
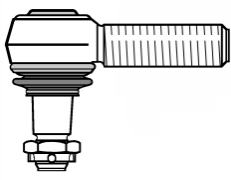
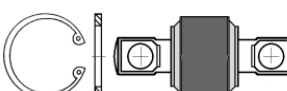

MERCEDES-BENZ

Originalni broj Cross-Ref.-No. Original Nr.	Br. FAD No. Nr.	Naziv Designation Bezeichnung	Kugla Ball Ø Größe	Konus Taper Konus	Dužina Length Länge	Skica Figure Bild
000 330 05 11 000 330 22 11	5128.96.00	Izmenljivi podsklop Repair kit Reparatur satz	55	Ø19 >24<	<130>	
000 330 07 07	5323.96.00	Izmenljivi podsklop Repair kit Reparatur satz	62	Ø17 >24<	<115>	
000 330 19 35 000 330 29 35 000 330 41 35 000 330 78 35 000 338 50 29 001 330 22 35 001 330 27 35	5848.10.00	Zglob,LH M35x1.5 * Ball joint, LH Kugelgelenk, LH	35	K26	150	
000 330 20 11	4569.96.00	Izmenljivi podsklop Repair kit Reparatur satz	62	Ø19 >24<	<130>	
000 330 40 35 000 330 49 29 000 330 77 35 001 330 21 35 001 330 26 35	5848.20.00	Zglob,RH M35x1.5 * Ball joint, RH Kugelgelenk, RH	35	K26	150	
000 330 50 35 000 460 21 48 000 460 41 48 000 460 45 48 000 460 85 48 310 330 04 35 310 330 08 35 310 330 13 35	5774.20.00	Zglob,RH M22x1.5 Ball joint, RH Kugelgelenk, RH	30	K18	95	
000 350 05 06	5170.96.00	Izmenljivi podsklop Repair kit Reparatur satz	70	Ø19 >30<	<130>	

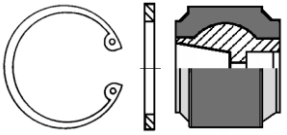
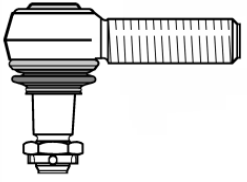
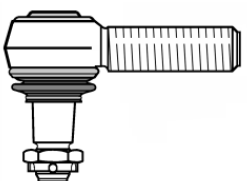
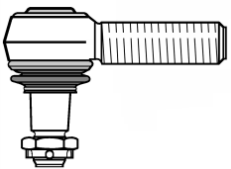
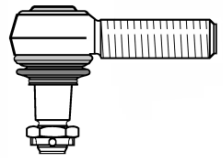
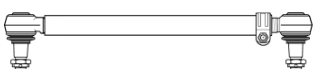
MERCEDES-BENZ

Originalni broj Cross-Ref.-No. Original Nr.	Br. FAD No. Nr.	Naziv Designation Bezeichnung	Kugla Ball Ø Größe	Konus Taper Konus	Dužina Length Länge	Skica Figure Bild
000 350 11 05	5705.96.00	Izmenljivi podsklop Repair kit Reparatur satz	95	K45		
000 460 03 48 000 460 28 48 000 460 29 48 001 460 08 48 001 460 12 48 001 460 22 48 001 460 77 48	5743.20.00	Zglob,RH M30x1.5 Ball joint, RH Kugelgelenk, RH	40	K30	120	
000 460 06 48 000 460 12 48 000 460 34 48 000 460 35 48 001 460 37 48 001 460 78 48 002 460 03 48	5743.10.00	Zglob,LH M30x1.5 Ball joint, LH Kugelgelenk, LH	40	K30	120	
000 460 77 48 001 460 21 48	6050.20.00	Zglob,RH M24x1.5 Ball joint, RH Kugelgelenk, RH	40	K30	120	
000 460 78 48 001 460 20 48	6050.10.00	Zglob,LH M24x1.5 Ball joint, LH Kugelgelenk, LH	40	K30	120	
300 460 02 05 300 460 03 05 301 460 00 05 301 460 01 05	5875.00.00	Spona upravljača Drag link Lenkstange Izmenljivi delovi Parts list Stuckliste 5741.20.00	35	K26	658 RØ40	

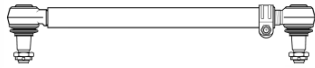
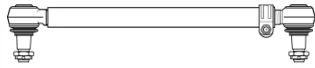

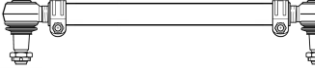
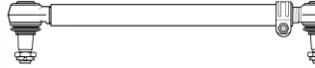

MERCEDES-BENZ

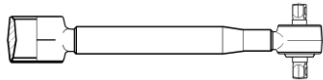
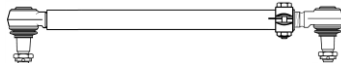
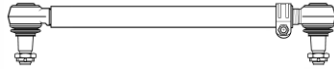
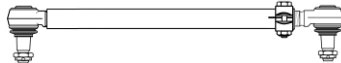
Originalni broj Cross-Ref.-No. Original Nr.	Br. FAD No. Nr.	Naziv Designation Bezeichnung	Kugla Ball Ø Größe	Konus Taper Konus	Dužina Length Länge	Skica Figure Bild
300 460 04 05 300 460 05 05 301 460 05 05	5835.00.00	Spona upravljača Drag link Lenkstange Izmenljivi delovi Parts list Stuckliste 5741.20.00	35	K26	1146 RØ40	
300 460 06 05 300 460 07 05 305 460 03 05	5283.00.00	Spona upravljača Drag link Lenkstange Izmenljivi delovi Parts list Stuckliste 5741.20.00	35	K26	975 RØ36	
302 330 09 03 302 330 13 03 302 330 15 03 302 330 17 03	5725.00.00	Poprečna spona Tie rod Spurstange Izmenljivi delovi Parts list Stuckliste 5848.10.00 5848.20.00	35	K26	1642 RØ40	
305 330 04 03 305 330 08 03 305 330 10 03 305 330 11 03 357 330 11 03 357 330 15 03	6901.00.00	Poprečna spona Tie rod Spurstange Izmenljivi delovi Parts list Stuckliste 5741.10.00 5741.20.00	35	K26	1705 RØ40	
305 460 06 05 357 460 12 05 357 460 13 05	5887.00.00	Spona upravljača Drag link Lenkstange Izmenljivi delovi Parts list Stuckliste 5741.20.00	35	K26	1160 RØ40	

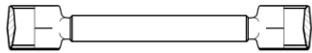
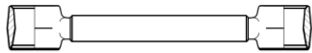
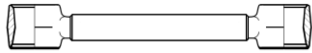
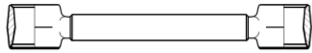

MERCEDES-BENZ

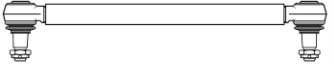
Originalni broj Cross-Ref.-No. Original Nr.	Br. FAD No. Nr.	Naziv Designation Bezeichnung	Kugla Ball Ø Größe	Konus Taper Konus	Dužina Length Länge	Skica Figure Bild
307 330 01 11 357 330 36 11	3310.00.00	Vodica mosta Torque rod Achsstrebe Izmenljivi delovi Parts list Stuckliste 3310.96.00	70	Ø16 >30<	689 RØ56	
307 460 00 05 307 460 05 05	5843.00.00	Spona upravljača Drag link Lenkstange Izmenljivi delovi Parts list Stuckliste 5741.20.00	35	K26	1130 RØ40	
307 460 04 05	5280.00.00	Spona upravljača Drag link Lenkstange Izmenljivi delovi Parts list Stuckliste 5741.20.00	35	K26	1000 RØ40	
309 460 31 05 309 460 03 05 309 460 04 05 309 460 05 05 309 460 08 05 309 460 09 05 309 460 10 05 309 460 11 05 309 460 12 05 309 460 13 05 309 460 14 05 309 460 20 05 309 460 22 05 309 460 23 05 309 460 24 05 309 460 25 05 309 460 26 05 309 460 29 05 309 460 29 05 601 460 00 05 601 460 01 05 601 460 02 05 601 460 03 05	5775.00.00	Spona upravljača Drag link Lenkstange Izmenljivi delovi Parts list Stuckliste 5774.20.00	30	K18	486 RØ26	

MERCEDES-BENZ

Originalni broj Cross-Ref.-No. Original Nr.	Br. FAD No. Nr.	Naziv Designation Bezeichnung	Kugla Ball Ø Größe	Konus Taper Konus	Dužina Length Länge	Skica Figure Bild
317 330 04 11 357 330 42 11	3609.38.00	Vođica mosta Torque rod Achsstrebe	83		960 RØ56	
317 350 06 06 357 330 34 11	3604.38.00	Vođica mosta Torque rod Achsstrebe	83		585 RØ56	
317 350 07 06 600 330 01 11	3602.38.00	Vođica mosta Torque rod Achsstrebe	83		724 RØ56	
322 330 10 11 357 330 31 11	3601.38.00	Vođica mosta Torque rod Achsstrebe	83		775 RØ56	
356 330 00 03 613 330 00 03	6050.00.00	Poprečna spona Tie rod Spurstange Izmenljivi delovi Parts list Stuckliste 6050.10.00 6050.20.00	40	K30	697 RØ32	
356 330 01 03 613 330 01 03	6054.00.00	Poprečna spona Tie rod Spurstange	40	K30	506 RØ30	
356 330 02 03	6051.00.00	Poprečna spona Tie rod Spurstange Izmenljivi delovi Parts list Stuckliste 6050.10.00 6050.20.00	40	K30	648 RØ32	

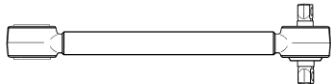
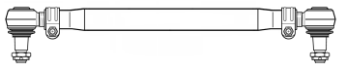

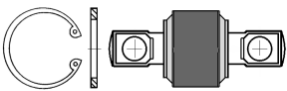
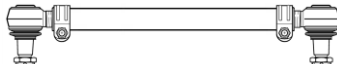
MERCEDES-BENZ

Originalni broj Cross-Ref.-No. Original Nr.	Br. FAD No. Nr.	Naziv Designation Bezeichnung	Kugla Ball Ø Größe	Konus Taper Konus	Dužina Length Länge	Skica Figure Bild
356 350 01 06	5708.00.00	Vođica mosta Torque rod Achsstrebe Izmenljivi delovi Parts list Stuckliste 5705.96.00 6071.96.00	80/62	Ø17 >24< <130> K45	628 RØ50	
356 463 00 15 613 463 00 15	6053.00.00	Spona upravljača Drag link Lenkstange Izmenljivi delovi Parts list Stuckliste 5743.10.00 5743.20.00	40	K30	1708 RØ58	
356 463 02 15	6052.00.00	Spona upravljača Drag link Lenkstange Izmenljivi delovi Parts list Stuckliste 5743.10.00 5743.20.00	40	K30	1453 RØ50	
357 330 00 35	5522.96.00	Izmenljivi podsklop Repair kit Reparatur satz	45	Ø15 >20<	<90>	
357 330 02 03 357 330 04 03 357 330 05 03	6817.00.00	Spona upravljača Drag link Lenkstange Izmenljivi delovi Parts list Stuckliste 5741.20.00 5741.10.00	35	K26	1734 RØ40	

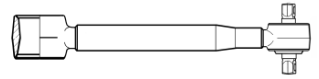
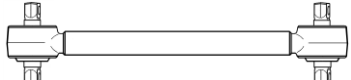
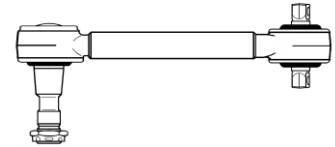
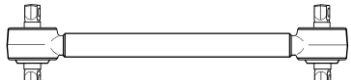
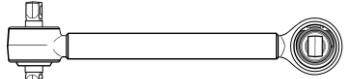

MERCEDES-BENZ

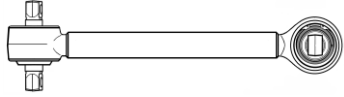
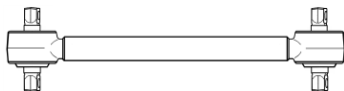
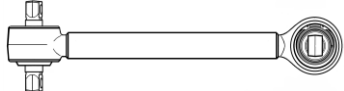
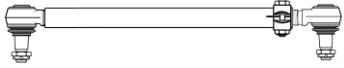
Originalni broj Cross-Ref.-No. Original Nr.	Br. FAD No. Nr.	Naziv Designation Bezeichnung	Kugla Ball Ø Größe	Konus Taper Konus	Dužina Length Länge	Skica Figure Bild
357 330 06 03 357 330 07 03	5976.00.00	Poprečna spona Tie rod Spurstange Izmenjivi delovi Parts list Stuckliste 4126.20.00	35	K26	1725 RØ50	
357 330 17 11	3952.00.00	Vođica mosta Torque rod Achsstrebe Izmenjivi delovi Parts list Stuckliste 3310.96.0	70	Ø16 >30< <130>	960 RØ56	
357 330 19 11 357 330 33 11	6910.00.00	Vođica mosta Torque rod Achsstrebe Izmenjivi delovi Parts list Stuckliste 3310.96.00	70	Ø16 >30< <130>	713 RØ56	
357 333 01 01	6059.00.00	Vođica mosta Torque rod Achsstrebe Izmenjivi delovi Parts list Stuckliste 5323.96.00	70 62	Ø17 >30< <115>	806 RØ50	
357 333 02 05	5956.00.00	Vođica mosta Torque rod Achsstrebe Izmenjivi delovi Parts list Stuckliste 5170.96.00	70	Ø19 >30< <130>	750 RØ50	
357 333 04 05	6039.00.00	Vođica mosta Torque rod Achsstrebe Izmenjivi delovi Parts list Stuckliste 5522.96.00	45	Ø15 >20< <90>	625 RØ36	

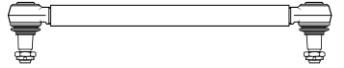

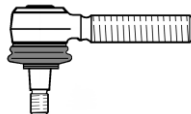
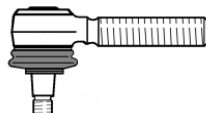
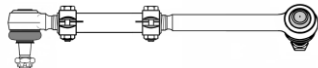

MERCEDES-BENZ

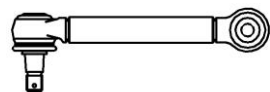
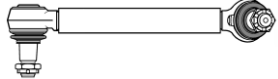
Originalni broj Cross-Ref.-No. Original Nr.	Br. FAD No. No. Nr.	Naziv Designation Bezeichnung	Kugla Ball Ø Größe	Konus Taper Konus	Dužina Length Länge	Skica Figure Bild
357 333 05 05 671 333 02 05	6905.00.00	Vodica mosta Torque rod Achsstrebe Izmenljivi delovi Parts list Stuckliste 5323.96.00	62	Ø17 >24< <115>	659 RØ50	
357 333 06 05 357 333 09 05	4488.00.00	Vodica mosta Torque rod Achsstrebe Izmenljivi delovi Parts list Stuckliste 5128.90.00	55	Ø19 >30< <130>	662 RØ50	
357 333 07 05 671 333 04 05	6906.00.00	Vodica mosta Torque rod Achsstrebe Izmenljivi delovi Parts list Stuckliste 5323.96.00	62	Ø17 >24< <115>	659 RØ50	
357 460 04 05 357 460 10 05 357 460 11 05	5865.00.00	Spona upravljača Drag link Lenkstange Izmenljivi delovi Parts list Stuckliste 5741.20.00	35	K26	988 RØ40	
357 460 14 05 357 460 15 05	3967.00.00	Spona upravljača Drag link Lenkstange Izmenljivi delovi Parts list Stuckliste 5741.20.00	35	K26	1066 RØ40	
357 460 32 05 671 460 03 05	6902.00.00	Spona upravljača Drag link Lenkstange	40	K30	920 RØ36	

MERCEDES-BENZ

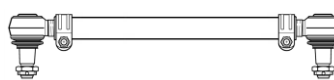
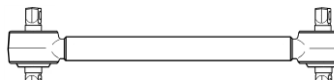
Originalni broj Cross-Ref.-No. Original Nr.	Br. FAD No. Nr.	Naziv Designation Bezeichnung	Kugla Ball Ø Größe	Konus Taper Konus	Dužina Length Länge	Skica Figure Bild
382 330 04 03 628 330 00 03 628 330 01 03	6155.00.00	Poprečna spona Tie rod Spurstange Izmenljivi delovi Parts list Stuckliste 3639.20.00	35	K26	1733 RØ62	
601 330 04 35	5886.20.00	Zglob,RH M20x1.5 Ball joint, RH Kugelgelenk, RH	25	K18	95	
601 330 05 35	5886.10.00	Zglob,LH M20x1.5 Ball joint, LH Kugelgelenk, LH	25	K18	95	
601 460 05 05 601 460 06 05 601 460 07 05 601 460 08 05 601 460 09 05 601 460 10 05 601 460 11 05 601 460 12 05 601 460 13 05 601 460 15 05	5852.00.00	Spona upravljača Drag link Lenkstange Izmenljivi delovi Parts list Stuckliste 5774.20.00	30	K18	483 RØ26	
602 330 00 03 602 330 01 03 602 330 03 03 602 330 52 03	5886.00.00	Poprečna spona Tie rod Spurstange Izmenljivi delovi Parts list Stuckliste 5886.20.00	25	K18	1356 RØ32	
628 320 01 89	6061.00.00	Stabilizator Stabillizer link Koppelstang	35	K26	260 RØ36	
628 320 03 89	6060.00.00	Stabilizator Stabillizer link Koppelstang	35	K26	260 RØ36	

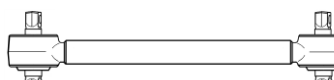

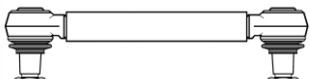
MERCEDES-BENZ

Originalni broj Cross-Ref.-No. Original Nr.	Br. FAD No. Nr.	Naziv Designation Bezeichnung	Kugla Ball Ø Größe	Konus Taper Konus	Dužina Length Länge	Skica Figure Bild
628 330 04 03 628 330 05 03	6909.00.00	Poprečna spona Tie rod Spurstange Izmenljivi delovi Parts list Stuckliste 5741.10.00 5741.20.00	35	K26	768 RØ40	
628 333 00 03 628 333 00 05 628 333 10 05 628 333 18 05 644 350 03 05	6885.00.00	Vođica mosta Torque rod Achsstrebe Izmenljivi delovi Parts list Stuckliste 5942.96.00	70	Ø19 >24< <130>	664 RØ50	
628 333 01 05	6918.00.00	Vođica mosta Torque rod Achsstrebe Izmenljivi delovi Parts list Stuckliste 4569.96.00	62	Ø19 >24< <130>	576 RØ50	
628 333 09 05 628 333 17 05 644 350 03 06	6913.00.00	Vođica mosta Torque rod Achsstrebe Izmenljivi delovi Parts list Stuckliste 5942.96.00	70	Ø19 >24< <130>	576 RØ50	
628 460 03 05 628 460 12 05	4576.00.00	Spona upravljača Drag link Lenkstange	40	K30	928 RØ42	
628 460 20 05	4595.00.00	Poprečna spona Tie rod Spurstange	40	K30	566 RØ36	

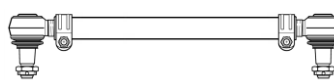
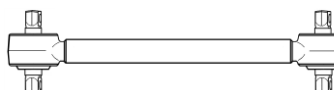
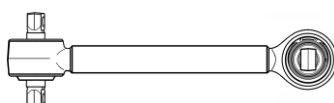
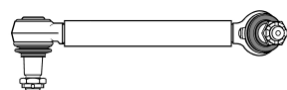
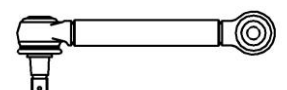
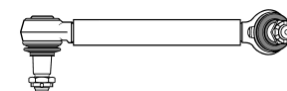
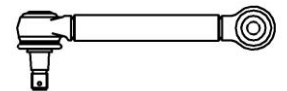

MERCEDES-BENZ

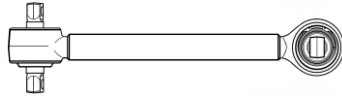
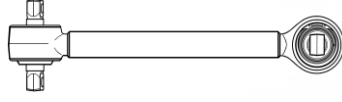
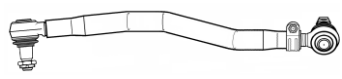
Originalni broj Cross-Ref.-No. Original Nr.	Br. FAD No. No. Nr.	Naziv Designation Bezeichnung	Kugla Ball Ø Größe	Konus Taper Konus	Dužina Length Länge	Skica Figure Bild
629 330 00 03 629 330 06 03 632 330 01 03	4581.00.00	Spona upravljača Drag link Lenkstange Izmenljivi delovi Parts list Stuckliste 5743.10.00 5743.20.00	40	K30	880 RØ40	
629 350 05 06 629 350 06 06	6197.00.00	Vođica mosta Torque rod Achsstrebe Izmenljivi delovi Parts list Stuckliste 5170.96.00	70	Ø19 >30< <130>	658 RØ50	
629 350 12 06 629 350 28 06	4566.00.00	Vođica mosta Torque rod Achsstrebe Izmenljivi delovi Parts list Stuckliste 5942.96.00	70	Ø19 >24< <130>	628 RØ50	
634 323 02 16 634 323 04 16	4586.00.00	Stabilizator Stabillizer link Koppelstang	35	K26	375 RØ36	
634 323 03 16 634 323 05 16	4587.00.00	Stabilizator Stabillizer link Koppelstang	35	K26	375 RØ36	
634 326 00 16 634 326 05 16	4588.00.00	Stabilizator Stabillizer link Koppelstang	35	K26	300 RØ36	
634 326 01 16 634 326 06 16	4589.00.00	Stabilizator Stabillizer link Koppelstang	35	K26	300 RØ36	

MERCEDES-BENZ

Originalni broj Cross-Ref.-No. Original Nr.	Br. FAD No. No. Nr.	Naziv Designation Bezeichnung	Kugla Ball Ø Größe	Konus Taper Konus	Dužina Length Länge	Skica Figure Bild
634 352 00 04	6156.00.00	Vodica mosta Torque rod Achsstrebe Izmenljivi delovi Parts list Stuckliste 4569.96.00	62	Ø19 >24< <130>	675 RØ50	
634 352 00 05	6157.00.00	Vodica mosta Torque rod Achsstrebe Izmenljivi delovi Parts list Stuckliste 4569.96.00	62	Ø19 >24< <130>	585 RØ50	
634 460 06 05	6154.00.00	Spona upravljača Drag link Lenkstange Izmenljivi delovi Parts list Stuckliste 5743.20.00	40	K30	933 RØ52	
667 460 15 05 667 460 17 05	4534.00.00	Spona upravljača Drag link Lenkstange Izmenljivi delovi Parts list Stuckliste 5746.20.00	30	K22	504 RØ36	
667 460 16 05 667 460 18 05	4573.00.00	Spona upravljača Drag link Lenkstange Izmenljivi delovi Parts list Stuckliste 5746.20.00	30	K22	485 RØ36	

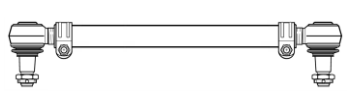
MERCEDES-BENZ

Originalni broj Cross-Ref.-No. Original Nr.	Br. FAD No. No. Nr.	Naziv Designation Bezeichnung	Kugla Ball Ø Größe	Konus Taper Konus	Dužina Length Länge	Skica Figure Bild
671 333 03 05	6158.00.00	Vodica mosta Torque rod Achsstrebe Izmenljivi delovi Parts list Stuckliste 5170.96.00	70	Ø19 >30< <130>	662 RØ50	
671 460 00 05 671 460 02 05	6900.00.00	Spona upravljača Drag link Lenkstange Izmenljivi delovi Parts list Stuckliste 5743.10.00 5743.20.00	40	K30	1140 RØ40	
901 460 01 48 901 460 03 48	1711.20.00	Zglob,RH M16x1.5 * Ball joint, RH Kugelgelenk, RH	25	K20	80	

RENAULT

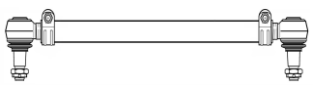
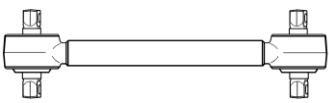
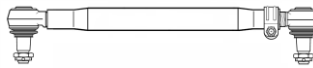
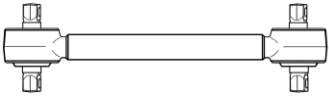
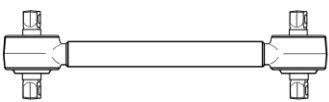

Originalni broj Cross-Ref.-No. Original Nr.	Br. FAD No. Nr.	Naziv Designation Bezeichnung	Kugla Ball Ø Größe	Konus Taper Konus	Dužina Length Länge	Skica Figure Bild
00 03 401 170 50 00 288 361 50 01 832 581 50 01 858 774	5743.10.00	Zglob, LH M30x1.5 Ball joint, LH Kugelgelenk, LH	40	K30	120	
00 03 406 169 00 03 406 236 00 03 406 251 00 03 406 254 00 03 406 260 00 03 406 261 50 00 288 360 50 00 590 236 50 00 804 824 50 01 858 773 77 01 011 412	5743.20.00	Zglob, RH M30x1.5 Ball joint, RH Kugelgelenk, RH	40	K30	120	
00 03 406 212 00 03 406 253 50 00 242 159 50 00 295 214 50 00 812 483 50 01 832 582 50 01 850 549 50 01 859 985 77 01 016 946	5741.20.00	Zglob, RH M30x1.5 Ball joint, RH Kugelgelenk, RH	35	K26	115	
00 03 406 218 50 00 295 215 50 01 834 533 50 01 850 550 50 01 852 263 50 01 859 984	5741.10.00	Zglob, LH M30x1.5 Ball joint, LH Kugelgelenk, LH	35	K26	115	
50 00 761 671 50 10 151 528 50 10 207 724	4731.00.00	Spona upravljača Drag link Lenkstange Izmenjivi delovi Parts list Stuckliste 4563.20.00	40	K30	1475 RØ40	
50 00 819 365 50 10 104 465	5992.96.00	Izmenjivi podsklop Repair kit Reparatur satz	62	Ø17 >24<	<122>	

RENAULT

Originalni broj Cross-Ref.-No. Original Nr.	Br. FAD No. No. Nr.	Naziv Designation Bezeichnung	Kugla Ball Ø Größe	Konus Taper Konus	Dužina Length Länge	Skica Figure Bild
50 10 104 286 50 10 207 728	4700.00.00	Spona upravljača Drag link Lenkstange	40	K30	555 RØ40	
50 10 104 287 50 10 207 729	4701.00.00	Spona upravljača Drag link Lenkstange Izmenjivi delovi Parts list Stuckliste 5743.10.00 5743.20.00	40	K30	525 RØ40	
50 10 197 399	3286.00.00	Vođica mosta Torque rod Achsstrebe Izmenjivi delovi Parts list Stuckliste 5992.96.00	62	Ø17 >24< <122>	570 RØ50	
50 10 207 725	4702.00.00	Spona upravljača Drag link Lenkstange Izmenjivi delovi Parts list Stuckliste 5743.20.00	40	K30	2085 RØ50	
50 10 207 726	3944.00.00	Vođica mosta Torque rod Achsstrebe Izmenjivi delovi Parts list Stuckliste 5992.96.00	62	Ø17 >24< <122>	550 RØ50	
50 10 207 727	3945.00.00	Vođica mosta Torque rod Achsstrebe Izmenjivi delovi Parts list Stuckliste 5992.96.00	62	Ø17 >24< <122>	692 RØ50	



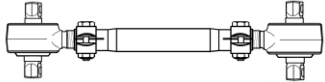

RENAULT

Originalni broj Cross-Ref.-No. Original Nr.	Br. FAD No. Nr.	Naziv Designation Bezeichnung	Kugla Ball Ø Größe	Konus Taper Konus	Dužina Length Länge	Skica Figure Bild
50 10 207 771	3288.00.00	Vođica mosta Torque rod Achsstrebe Izmenjivi delovi Parts list Stuckliste 5992.96.00	62	Ø17 >24< <122>	490 RØ50	
50 10 393 015	4732.00.00	Poprečna spona Tie rod Spurstange Izmenjivi delovi Parts list Stuckliste 5741.10.00 5741.20.00	35	K26	776 RØ40	

SCANIA

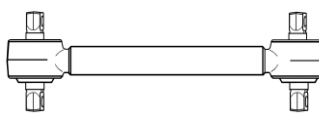
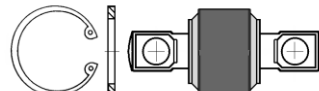
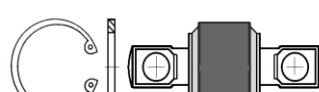
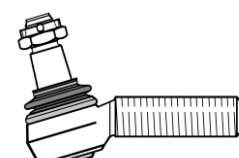
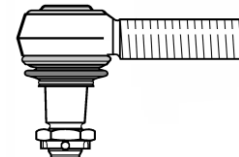



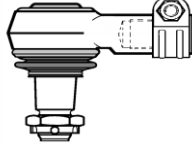
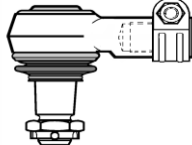
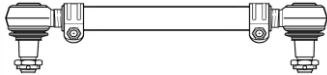
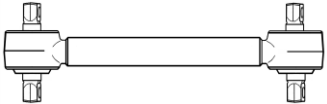
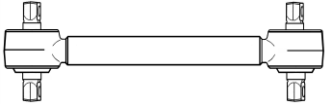
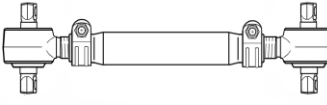

Originalni broj Cross-Ref.No. Original Nr.	Br. FAD No. Nr.	Naziv Designation Bezeichnung	Kugla Ball Ø Größe	Konus Taper Konus	Dužina Length Länge	Skica Figure Bild
1 101 843 1 379 423 1 393 298 1 942 075	6841.00.00	Vođica mosta Torque rod Achsstrebe Izmenjivi delovi Parts list Stuckliste 6409.96.00	55	Ø17 >24< <115>	752 RØ50	
1 104 334 550 806 639 370	5323.96.00	Izmenjivi podsklop Repair kit Reparatur satz	62	Ø17 >24<	<115>	
1 104 335 1 953 248 638 862 639 287	5170.96.00	Izmenjivi podsklop Repair kit Reparatur satz	70	Ø19 >30<	<130>	
1 357 674 1 738 379	6832.20.00	Zglob,RH M30x1,5 Ball joint, RH Kugelgelenk, RH	40	K30	140	
1 358 792 1 738 380 1 914 426 2 051 165 283 784 395 010	5743.10.00	Zglob,RH M30x1.5 Ball joint, RH Kugelgelenk, RH	40	K30	120	
1 361 413 1 395 614 1 734 019 1 897 333 2 040 254 2 146 105	6832.00.00	Poprečna spona Tie rod Spurstange Izmenjivi delovi Parts list Stuckliste 6832.20.00	40	K30	1743 RØ62	

SCANIA

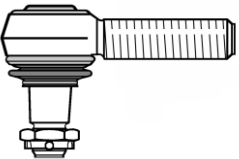
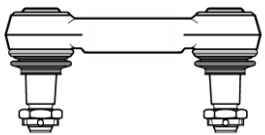
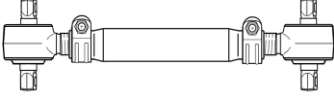

Originalni broj Cross-Ref.-No. Original Nr.	Br. FAD No. Nr.	Naziv Designation Bezeichnung	Kugla Ball Ø Größe	Konus Taper Konus	Dužina Length Länge	Skica Figure Bild
1 394 443	7981.20.00	Zglob, RH 26x1.5 * Ball joint, RH Kugelgelenk, RH	40	K30	75	
1 394 444	7982.20.00	Zglob, RH 26x1.5 * Ball joint, RH Kugelgelenk, RH	40	K30	90	
1 397 866 1 734 020 2 028 998 2 113 904 395 350	3126.00.00	Poprečna spona Tie rod Spurstange Izmenjivi delovi Parts list Stuckliste 5743.20.00 5743.10.00	40	K30	1736 RØ40	
1 431 471 477 889	4785.00.00	Vodica mosta Torque rod Achsstrebe Izmenjivi delovi Parts list Stuckliste 5323.96.00	62	Ø17 >24< <115>	532 RØ50	
1 431 472 1 770 732 477 890	4779.00.00	Vodica mosta Torque rod Achsstrebe Izmenjivi delovi Parts list Stuckliste 5323.96.00	62	Ø17 >24< <115>	637 RØ50	
1 431 475 481 959	4782.00.00	Vodica mosta Torque rod Achsstrebe Izmenjivi delovi Parts list Stuckliste 5170.96.00	70	Ø19 >30< <130>	670 RØ50	

SCANIA

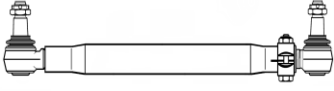
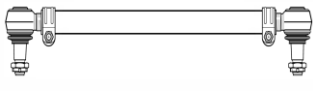
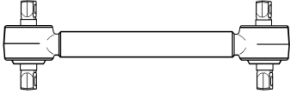
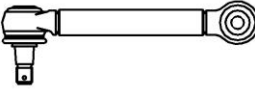

Originalni broj Cross-Ref.-No. Original Nr.	Br. FAD No. Nr.	Naziv Designation Bezeichnung	Kugla Ball Ø Größe	Konus Taper Konus	Dužina Length Länge	Skica Figure Bild
1 438 475 1 863 130	4792.00.00	Vodica mosta Torque rod Achsstrebe Izmenjivi delovi Parts list Stuckliste 5323.96.00	62	Ø17 >24< <115>	539 RØ50	
1 455 327 1 751 418 1 789 082 1 928 859 483 527	6844.00.00	Stabilizator Stabilizer link Koppelstang	35	K26	282 RØ36	
1 738 381 1 767 328 1 914 427 2 051 166 283 784 395 010	5743.20.00	Zglob, LH M30x1.5 Ball joint, LH Kugelgelenk, LH	40	K30	120	
1 766 015 445 626	6851.00.00	Stabilizator Stabilizer link Koppelstang	35	K26	130 RØ32	
1 796 671 445 599 489 989	3361.00.00	Vodica mosta Torque rod Achsstrebe Izmenjivi delovi Parts list Stuckliste 5170.96.00	70	Ø19 >30< <130>	650 RØ50	
1 897 671 481 690	4777.00.00	Spona upravljača Drag link Lenkstange Izmenjivi delovi Parts list Stuckliste 5856.20.00	40	K30	1256 RØ62	

SCANIA

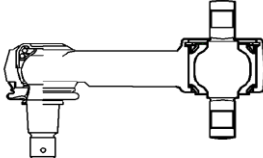
Originalni broj Cross-Ref.-No. Original Nr.	Br. FAD No. No. Nr.	Naziv Designation Bezeichnung	Kugla Ball Ø Größe	Konus Taper Konus	Dužina Length Länge	Skica Figure Bild
1 897 673 475 463	6834.00.00	Spona upravljača Drag link Lenkstange Izmenjivi delovi Parts list Stuckliste 5743.20.00	40	K30	870 RØ50	
434 493	4795.00.00	Spona upravljača Drag link Lenkstange Izmenjivi delovi Parts list Stuckliste 6321.10.00 4563.20.00	40	K30	672 RØ40	
465 816 466 801 489 987	3362.00.00	Vođica mosta Torque rod Achsstrebe Izmenjivi delovi Parts list Stuckliste 5170.96.00	70	Ø19 >30< <130>	650 RØ50	
486 590	4787.00.00	Stabilizator Stabillizer link Koppelstang	35	K26	160 RØ32	
488 056	4788.00.00	Stabilizator Stabillizer link Koppelstang	35	K26	160 RØ32	
488 739	4784.00.00	Stabilizator Stabillizer link Koppelstang Izmenjivi delovi Parts list Stuckliste 5522.96.00	35/45	K26	145 RØ32	

SCANIA



Originalni broj Cross-Ref.-No. Original Nr.	Br. FAD No. No. Nr.	Naziv Designation Bezeichnung	Kugla Ball Ø Größe	Konus Taper Konus	Dužina Length Länge	Skica Figure Bild
550 808	6409.96.00	Izmenjivi podsklop Repair kit Reparatur satz	55	Ø17 >24<	<115>	
621 863	3363.00.00	Vodica mosta Torque rod Achsstrebe Izmenjivi delovi Parts list Stuckliste 3363.96.00	70	>32<	990 RØ50	
638 860	3363.96.00	Izmenjivi podsklop Repair kit Reparatur satz	70	Ø32	166	
638 861	5847.96.00	Izmenjivi podsklop Repair kit Reparatur satz	85	K45	133	
649 346	3364.00.00	Vodica mosta Torque rod Achsstrebe Izmenjivi delovi Parts list Stuckliste 3363.96.00 5847.96.00	70	K45 Ø32	803 RØ50	
651 156	3365.00.00	Vodica mosta Torque rod Achsstrebe Izmenjivi delovi Parts list Stuckliste 3363.96.00 5847.96.00	70	K45 Ø32	725 RØ50	

SOLARIS

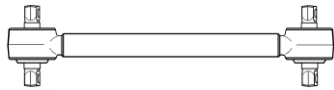
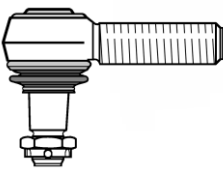
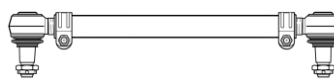
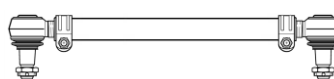
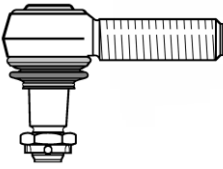
Originalni broj Cross-Ref.-No. Original Nr.	Br. FAD No. No. Nr.	Naziv Designation Bezeichnung	Kugla Ball Ø Größe	Konus Taper Konus	Dužina Length Länge	Skica Figure Bild
0720 385 069	6086.00.00	Vođica mosta Torque rod Achsstrebe Izmenjivi delovi Parts list Stuckliste 5117.96.00	62	Ø19 >24< <130>	662 RØ50	
0801 211 835 0820 352 140	4563.20.00	Zglob, RH M30x1,5 Ball joint, RH Kugelgelenk, RH	40	K30	120	
0820 352 208	6068.00.00	Poprečna spona Tie rod Spurstange Izmenjivi delovi Parts list Stuckliste 6321.10.00 4563.20.00	40	K30	738 RØ40	
0820 352 211	6069.00.00	Poprečna spona Tie rod Spurstange Izmenjivi delovi Parts list Stuckliste 5741.10.00 5741.20.00	35	K26	707 RØ40	
0820 352 213	5741.10.00	Zglob, LH M30x1,5 Ball joint, LH Kugelgelenk, LH	35	K26	115	

SOLARIS



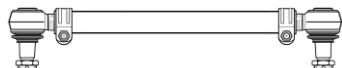
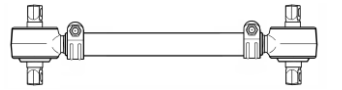
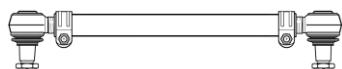
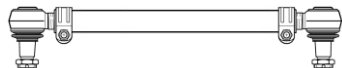
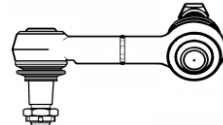
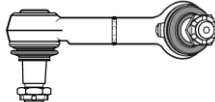

Originalni broj Cross-Ref.-No. Original Nr.	Br. FAD No. Nr.	Naziv Designation Bezeichnung	Kugla Ball Ø Größe	Konus Taper Konus	Dužina Length Länge	Skica Figure Bild
0870 006 836	6067.00.00	Poprečna spona Tie rod Spurstange Izmenjivi delovi Parts list Stuckliste 6321.10.00 4563.20.00	40	K30	1720 RØ40	
0870 317 843	6087.00.00	Vođica mosta Torque rod Achsstrebe Izmenjivi delovi Parts list Stuckliste 4569.96.00	62	Ø19 >24< <130>	576 RØ46	
1203 228 500	6063.00.00	Spona upravljača Drag link Lenkstange Izmenjivi delovi Parts list Stuckliste 6321.10.00 4563.20.00	40	K30	840 RØ40	
1203 228 520	6064.00.00	Spona upravljača Drag link Lenkstange Izmenjivi delovi Parts list Stuckliste 6321.10.00 4563.20.00	40	K30	510 RØ40	
1203 228 600	6065.00.00	Stabilizator Stabillizer link Koppelstang	40	K30	148 RØ32	
1203 228 700	6066.00.00	Stabilizator Stabillizer link Koppelstang	40	K30	148 RØ32	

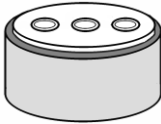
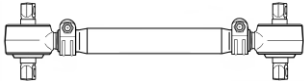
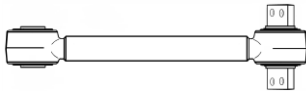
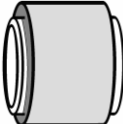
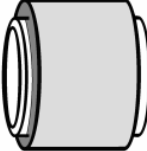
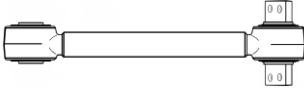
VOLVO

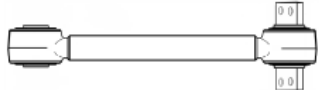

Originalni broj Cross-Ref.-No. Original Nr.	Br. FAD No. No. Nr.	Naziv Designation Bezeichnung	Kugla Ball Ø Größe	Konus Taper Konus	Dužina Length Länge	Skica Figure Bild
1 075 255 1 591 689 20 554 908 3 173 759	5580.90.00	Izmenjivi podsklop Repair kit Reparatur satz	138	K87	96	
1 075 260 1 629 072	4256.00.00	Vođica mosta Torque rod Achsstrebe Izmenjivi delovi Parts list Stuckliste 5581.90.00	91	Ø14 <125>	666 RØ50	
1 082 104 1 605 035	6758.00.00	Vođica mosta Torque rod Achsstrebe Izmenjivi delovi Parts list Stuckliste 5581.90.00 5597.90.00	91	Ø14 >20< <125>	666 RØ58	
1 134 955	5388.90.00	Izmenjivi podsklop Repair kit Reparatur satz	57.5	Ø28	55	
1 135 080	5597.90.00	Izmenjivi podsklop Repair kit Reparatur satz	91.3	Ø52	74	
1 135 427	5599.00.00	Vođica mosta Torque rod Achsstrebe Izmenjivi delovi Parts list Stuckliste 5597.90.00 5581.90.00	91	Ø14 >20< <125>	666 RØ58	

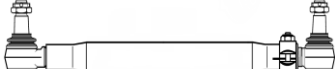
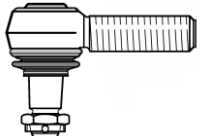
VOLVO
FAD

Originalni broj Cross-Ref.-No. Original Nr.	Br. FAD No. No.	Naziv Designation Bezeichnung	Kugla Ball Ø Größe	Konus Taper Konus	Dužina Length Länge	Skica Figure Bild
1 135 429 8 365 399	6756.00.00	Vođica mosta Torque rod Achsstrebe Izmenjivi delovi Parts list Stuckliste 5597.90.00 5581.90.00	91	Ø14 >20< <125>	510 RØ58	
1 194 390	6753.00.00	Poprečna spona Tie rod Spurstange Izmenjivi delovi Parts list Stuckliste 7720.10.00 7720.20.00	40	K31.5	1674 RØ42	
1 197 338	5493.00.00	Spona upravljača Drag link Lenkstange Izmenjivi delovi Parts list Stuckliste 5493.20.00	40	K31.5	1025 RØ60	
1 197 339	4252.00.00	Spona upravljača Drag link Lenkstange Izmenjivi delovi Parts list Stuckliste 7720.20.00	40	K31.5	1028 RØ60	
1 507 826 1 695 585 1 695 776 1 698 557 6 882 111 6 889 480 6889 482 85 114 146	7720.20.00	Zglob, RH 30x1.5 Ball joint, RH Kugelgelenk, RH	40	K31.5	120	

VOLVO

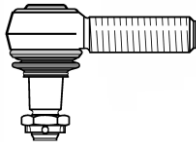
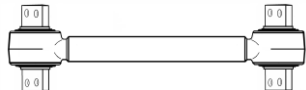
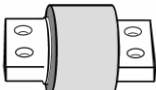
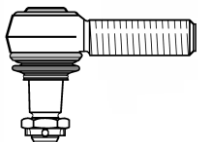
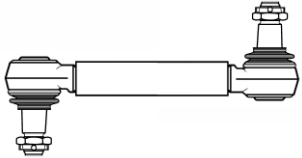
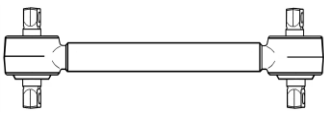



Originalni broj Cross-Ref.-No. Original Nr.	Br. FAD No. No. Nr.	Naziv Designation Bezeichnung	Kugla Ball Ø Größe	Konus Taper Konus	Dužina Length Länge	Skica Figure Bild
1 527 234 382 745	6762.20.00	Zglob, RH 28x1.5 Ball joint, RH Kugelgelenk, RH	25	K16	85	
1 589 817	5584.00.00	Vođica mosta Torque rod Achsstrebe Izmenjivi delovi Parts list Stuckliste 5581.90.00	91	Ø14 >20< <125>	666 RØ58	
1 598 588	5581.90.00	Izmenjivi podsklop Repair kit Reparatur satz	91	Ø14	<125>	
1 698 558 1 698 840 6 869 744 85 114 147	7720.10.00	Zglob,LH M30x1.5 Ball joint, LH Kugelgelenk, LH	40	K31.5	120	
20 443 063 20 443 067 20 539 988 20 994 420	6262.00.00	Stabilizator Stabilizer link Koppelstang	40	K28.6	350 RØ36	
20 453 121 20 453 123	4264.00.00	Vođica mosta Torque rod Achsstrebe Izmenjivi delovi Parts list Stuckliste 5323.96.00	62	Ø17 >24< <115>	449 RØ50	

VOLVO





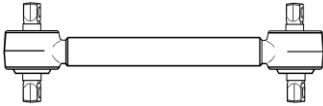
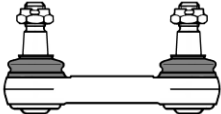
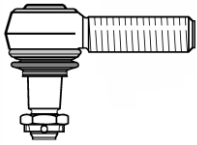
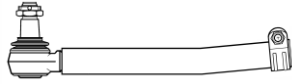
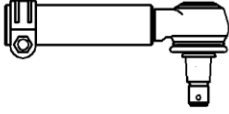

Originalni broj Cross-Ref.-No. Original Nr.	Br. FAD No. Nr.	Naziv Designation Bezeichnung	Kugla Ball Ø Größe	Konus Taper Konus	Dužina Length Länge	Skica Figure Bild
20 490 123 20 745 923 21 308 022 9 519 278	5494.00.00	Spona upravljača Drag link Lenkstange Izmenjivi delovi Parts list Stuckliste 5494.20.00	40	K28.8	1025 RØ60	
20 497 798 3 112 050 85 114 240 9 959 151	6261.00.00	Stabilizator Stabilizer link Koppelstang	40	K28.6	300 RØ30	
20 497 799 3 112 273 9 959 152	6263.00.00	Poprečna spona Tie rod Spurstange	40	K28.6	743 RØ40	
20 497 800 3 112 122 85 114 185 9 959 153	6731.00.00	Spona upravljača Drag link Lenkstange Izmenjivi delovi Parts list Stuckliste 5596.20.00	35	K28.6	763 RØ40	
20 739 082 70 311 664	6260.00.00	Spona upravljača Drag link Lenkstange	35	K28.6	1243 RØ40	
21 426 652 21 525 264 22 627 712 70 311 662 85 115 635	6274.00.00	Spona upravljača Drag link Lenkstange Izmenjivi delovi Parts list Stuckliste 4233.20.00	40	K28.6	1728 RØ50	

VOLVO
FAD

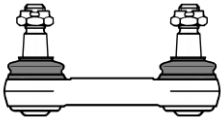
Originalni broj Cross-Ref.-No. Original Nr.	Br. FAD No. Nr.	Naziv Designation Bezeichnung	Kugla Ball Ø Größe	Konus Taper Konus	Dužina Length Länge	Skica Figure Bild
21 461 309 70 371 272	6283.00.00	Vođica mosta Torque rod Achsstrebe Izmenjivi delovi Parts list Stuckliste 6271.90.00	70	Ø17 >24< <115>	444 RØ50	
22 342 057 24 425 411	6272.00.00	Stabilizator Stabilizer link Koppelstang	40	K30	160 RØ32	
3 097 999 85 104 188	5494.20.00	Zglob,RH M20x1.5 Ball joint, RH Kugelgelenk, RH	40	K28.8	120	
3 098 294 85 104 265 85 114 167	6748.00.00	Spona upravljača Drag link Lenkstange	40	K28.6	495 RØ40	
3 098 295 85 104 266	6263.10.00	Zglob,RH 28x1.5* Ball joint, RH Kugelgelenk, RH	40	K28.6	202	
3 111 274 85 104 649	6269.90.00	Izmenjivi podsklop Repair kit Reparatur satz		K35	<72>	
3 112 049 70 308 561	6270.90.00	Izmenjivi podsklop Repair kit Reparatur satz		K43	<81>	

VOLVO

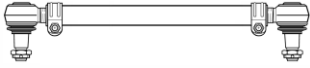
Originalni broj Cross-Ref.-No. Original Nr.	Br. FAD No. Nr.	Naziv Designation Bezeichnung	Kugla Ball Ø Größe	Konus Taper Konus	Dužina Length Länge	Skica Figure Bild
3 112 282	6281.00.00	Stabilizator Stabilizer link Koppelstang	40	K30	220 RØ32	
3 116 050	4209.00.00	Poprečna spona Tie rod Spurstange Izmenjivi delovi Parts list Stuckliste 7720.20.00	40	K31.5	1820 RØ50	
6 771 112	5140.00.00	Poprečna spona Tie rod Spurstange Izmenjivi delovi Parts list Stuckliste 5741.10.00 5741.20.00	35	K26	1582 RØ40	
70 311 665	6273.00.00	Spona upravljača Drag link Lenkstange Izmenjivi delovi Parts list Stuckliste 5596.20.00	35	K28.6	793 RØ42	
8 156 123	6754.00.00	Poprečna spona Tie rod Spurstange Izmenjivi delovi Parts list Stuckliste 5596.10.00 5596.20.00	35	K28.6	1674 RØ42	

VOLVO

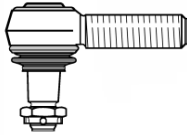
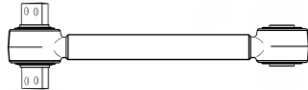
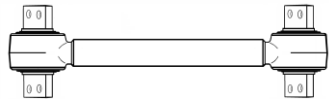
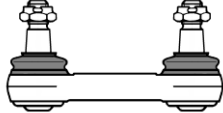
Originalni broj Cross-Ref.-No. Original Nr.	Br. FAD No. No.	Naziv Designation Bezeichnung	Kugla Ball Ø Größe	Konus Taper Konus	Dužina Length Länge	Skica Figure Bild
85 112 073 85 125 126	5596.20.00	Zglob,RH M30x1.5 Ball joint, RH Kugelgelenk, RH	35	K28.6	115	
9 523 794	6759.00.00	Vodica mosta Torque rod Achsstrebe Izmenjivi delovi Parts list Stuckliste 5581.90.00 5597.90.00	91	Ø14 >20< <125>	535 RØ60	
9 523 795	6755.00.00	Vodica mosta Torque rod Achsstrebe Izmenjivi delovi Parts list Stuckliste 5581.90.00	91	Ø14 >20< <125>	535 RØ58	
9 959 503	4237.00.00	Stabilizator Stabilizer link Koppelstang	40	K31,5	150 RØ32	



Pregled uporednih oznaka OEM / FAD

Cross references OEM / FAD



IVECO, IRISBUS, IRIZAR /FAD

OEM	FAD	OEM	FAD	OEM	FAD
296 6252	5743.20.00	856 5366	5122.20.00		
296 9808	5743.20.00	857 0528	5148.00.00		
298 0323	5741.20.00	858 2332	5122.20.00		
298 0129	5741.10.00	9319 2809	6426.20.00		
298 0884	5959.90.00	9380 0662	1480.20.00		
298 4061	5743.10.00	9380 2209	1481.20.00		
298 4511	5741.10.00	9380 4059	1480.20.00		
309 6213	5741.20.00	9380 4060	1481.20.00		
4100 5450	6439.00.00	9840 2553	6402.00.00		
4100 5451	6439.00.00	9848 4091	6395.00.00		
4103 6943	6418.00.00	9848 8010	5114.00.00		
4103 6944	6439.00.00	9848 8010	5103.00.00		
4104 2730	6439.00.00	9944 4744	6344.00.00		
4212 5057	5114.00.00	9945 5009	6433.00.00		
4248 3386	5743.20.00	9948 7779	6344.00.00		
4248 3520	5741.20.00				
4248 8269	5743.20.00				
4248 8722	5170.96.00				
4248 9395	5743.10.00				
4248 9573	5743.20.00				
4248 9574	5743.10.00				
4248 9594	5743.20.00				
4249 1638	5743.20.00				
4249 1957	5743.10.00				
4249 3781	5741.20.00				
4249 3782	5741.10.00				
4253 3101	6425.20.00				
4253 3102	6425.20.00				
468 8941	5122.20.00				
471 4134	5114.00.00				
480 2443	5743.20.00				
480 2444	5743.10.00				
483 3821	5741.10.00				
483 3826	5741.10.00				
483 3828	5741.10.00				
483 3829	5743.20.00				
483 3830	5743.10.00				
485 4871	6404.00.00				
500 307 556	6402.00.00				
500 333 284	4569.96.00				
500 336 085	6433.00.00				
504 113 824	6446.00.00				
504 113 827	6445.00.00				
5801 890 971	6445.00.00				
59 4989 0760	5741.20.00				
716 7757	5122.20.00				
812 2752	5743.20.00				
812 2755	5741.10.00				
816 3773	6439.00.00				
819 0225	5743.10.00				



KÄSSBOHRER/FAD

OEM	FAD	OEM	FAD
628 330 05 03	6909.00.00	8.226.148.000 C	5687.00.00
6.284.600.305	4576.00.00	8.226.225.000 D	6045.00.00
628 460 20 05	4595.00.00	8.226.238.000 C	6048.00.00
6.293.500.606	6197.00.00	8.226.244.000 D	3492.00.00
6.851.446.000	5742.10.00	8.226.247.000 C	6049.00.00
6.851.447.000	5742.20.00	8.226.248.000 C	4911.00.00
6.851.459.000	5742.10.00	8.226.249.000 C	6040.00.00
6.851.475.000	5743.20.00	8.226.250.000 C	6041.00.00
6.851.478.000	5742.20.00	8.226.258.000 C	3492.00.00
6.851.479.000	5742.10.00	8.226.259.000 C	3494.00.00
6.851.480.000	5743.20.00	8.226.261.000 C	6043.00.00
6.851.484.000	5743.20.00	8.226.262.000 C	3494.00.00
6.851.485.000	5743.10.00	8.226.280.000 B	4920.00.00
6.851.486.000	5742.20.00	8.226.280.000 C	4920.00.00
6.851.487.000	5742.10.00	8.226.293.000 B	6197.00.00
6.851.488.000	5742.20.00	8.226.305.000 C	5686.00.00
6.851.490.000	3581.10.00	8.226.308.000 C	4911.00.00
6.851.491.000	3581.20.00	8.226.313.000 C	5686.00.00
6.851.517.000	5741.20.00	8.226.318.000 B	3497.00.00
6.851.523.000	5742.20.00	8.226.323.000 B	3497.00.00
6.851.529.000	4911.20.00	8.226.355.000	4920.00.00
6.851.531.000	5743.20.00	8.226.380.000 C	4914.00.00
6.851.532.000	5742.10.00	8.226.380.000.0	4914.00.00
8.226.137.000	5686.00.00	82 262 320 660	5170.96.00
8.226.138.000	5687.00.00	82.262.800.000	4920.00.00
8.226.232.000	3491.00.00	82.263.550.000	4920.00.00
8.226.236.058	5743.10.00		
8.226.236.059	5743.20.00		
8.226.241.000	3491.00.00		
8.226.250.0000	6041.00.00		
8.226.257.000	6042.00.00		
8.226.259.000	3494.00.00		
8.226.262.000	3494.00.00		
8.226.306.000	3492.00.00		
8.226.307.000	6049.00.00		
8.226.308.000	4911.00.00		
8.226.328.000	4912.00.00		
8.226.330.000	4915.00.00		
8.226.347.000	6049.00.00		
8.226.356.000	4913.00.00		
8.226.357.000	3491.00.00		
8.226.380.000	4914.00.00		
8.226.381.000	4911.00.00		
8.321.999.319	3590.20.00		
8.226.147.000 C	5686.00.00		

MAN/FAD

OEM	FAD	OEM	FAD	OEM	FAD
36 46610 6000	6699.00.00	81 46610 6202	5932.00.00	81 46611 6108	6688.00.00
36 46710 6003	6698.00.00	81 46610 6257	5946.00.00	81 46611 6115	6689.00.00
36 46710 6005	6698.00.00	81 46610 6258	5932.00.00	81 46611 6120	6688.00.00
81 43220 6025	5948.00.00	81 46610 6292	5235.00.00	81 46611 6125	6688.00.00
81 43220 6042	5951.00.00	81 46610 6374	5975.00.00	81 46611 6126	6689.00.00
81 43220 6043	5952.00.00	81 46610 6376	6206.00.00	81 46611 6129	6688.00.00
81 43220 6055	5170.96.00	81 46610 6409	5932.00.00	81 46611 6131	6687.00.00
81 43220 6073	5170/96/00	81 46610 6415	5946.00.00	81 46611 6150	6681.00.00
81 43220 6099	5956.00.00	81 46610 6424	5235.00.00	81 46710 6080	5933.00.00
81 43220 6100	5956/00/00	81 46610 6432	5235.00.00	81 46710 6081	5934.00.00
81 43220 6102	5538.00.00	81 46610 6434	5235.00.00	81 46710 6117	4104.00.00
81 43220 6108	5959.90.00	81 46610 6437	5235.00.00	81 46710 6122	4134.00.00
81 43220 6144	4107.00.00	81 46610 6476	5946.00.00	81 46710 6136	5933.00.00
81 43220 6148	5538.00.00	81 46610 6503	5946.00.00	81 46710 6137	5934.00.00
81 43220 6151	6194.00.00	81 46610 6504	5932.00.00	81 46710 6167	4134.00.00
81 43220 6152	5538.00.00	81 46610 6513	5235.00.00	81 46710 6172	5933.00.00
81 43220 6161	4108.00.00	81 46610 6531	5932.00.00	81 46710 6173	5934.00.00
81 43220 6168	5339.00.00	81 46610 6532	5946.00.00	81 46710 6175	3777.00.00
81 43220 6174	6191.00.00	81 46610 6537	5235.00.00	81 46710 6176	3776.00.00
81 43220 6183	6194.00.00	81 46610 6548	6691.00.00	81 46710 6194	4134.00.00
81 43220 6186	5538.00.00	81 46610 6593	5932.00.00	81 46710 6195	4134.00.00
81 43220 6189	4107.00.00	81 46610 6596	5235.00.00	81 46710 6236	5210.00.00
81 43220 6190	4108.00.00	81 46610 6606	4097.00.00	81 46710 6242	3777.00.00
81 43220 6210	4107.00.00	81 46610 6608	5946.00.00	81 46710 6251	3777.00.00
81 43220 6211	4107.00.00	81 46610 6609	5932.00.00	81 46710 6267	5210.00.00
81 43220 6258	6683.00.00	81 46610 6614	5235.00.00	81 46710 6268	5210.00.00
81 43220 6264	6683.00.00	81 46610 6630	5946.00.00	81 46710 6281	4104.00.00
81 43220 6275	6683.00.00	81 46610 6631	5932.00.00	81 46710 6282	4104.00.00
81 43220 6276	6194.00.00	81 46610 6635	5235.00.00	81 46710 6294	5934.00.00
81 43220 6277	6194.00.00	81 46610 6648	6681.00.00	81 46710 6295	5933.00.00
81 43220 6278	6683.00.00	81 46610 6689	6203.00.00	81 46710 6337	5933.00.00
81 43220 6279	6683.00.00	81 46610 6708	6198.00.00	81 46710 6340	3776.00.00
81 43220 6390	6194.00.00	81 46610 6716	6202.00.00	81 46710 6344	3776.00.00
81 43220 6391	6683.00.00	81 46610 6720	6203.00.00	81 46710 6345	5933.00.00
81 43220 6396	4107.00.00	81 46610 6721	6203.00.00	81 46710 6355	5210.00.00
81 43220 6397	4108.00.00	81 46610 6735	5235.00.00	81 46710 6356	5210.00.00
81 43220 6409	4107.00.00	81 46610 6740	5932.00.00	81 46710 6370	4104.00.00
81 43230 6037	5537.00.00	81 46610 6743	5235.00.00	81 46710 6371	4104.00.00
81 43230 9037	5537.00.00	81 46610 6756	6211.00.00	81 46710 6372	4104.00.00
81 43250 6011	4137.00.00	81 46610 6795	6689.00.00	81 46710 6373	5210.00.00
81 43250 6016	4137.00.00	81 46610 6803	6325.00.00	81 46710 6378	4134.00.00
81 43315 6012	5535.00.00	81 46611 6019	5975.00.00	81 46710 6379	4134.00.00
81 43718 6006	5522.00.00	81 46611 6045	6689.00.00	81 46710 6380	4134.00.00
81 43718 6007	5522.00.00	81 46611 6047	6689.00.00	81 46710 6419	5934.00.00
81 43718 6009	5522.96.00	81 46611 6049	6689.00.00	81 46710 6420	3777.00.00
81 46610 6147	5946.00.00	81 46611 6051	5235.00.00	81 46710 6421	5933.00.00
81 46610 6194	5946.00.00	81 46611 6052	5235.00.00	81 46710 6422	3776.00.00
81 46610 6195	5946.00.00	81 46611 6065	6691.00.00	81 46710 6444	5934.00.00
81 46610 6196	5932.00.00	81 46611 6067	6198.00.00	81 46710 6451	5933.00.00
81 46610 6201	5946.00.00	81 46611 6068	6202.00.00	81 46710 6453	4123.00.00

MAN/FAD



OEM	FAD	OEM	FAD	OEM	FAD
81 46710 6457	4123.00.00	81 46711 6823	6791.00.00	81 95301 6234	5743.20.00
81 46710 6458	4123.00.00	81 46711 6830	4134.00.00	81 95301 6237	5743.10.00
81 46710 6459	5976.00.00	81 46711 6842	6791.00.00	81 95301 6239	5741.20.00
81 46710 6761	5934.00.00	81 46711 6844	6193.00.00	81 95301 6274	5743.20.00
81 46710 6806	5976.00.00	81 46711 6845	6792.00.00	81 95301 6279	5743.10.00
81 46710 6818	5976.00.00	81 46711 6846	4132.00.00	81 95301 6360	5741.20.00
81 46710 6819	5976.00.00	81 46711 6874	4096.00.00	81 95301 6361	5741.10.00
81 46710 6830	4134.00.00	81 46711 6875	4096.00.00	81 95302 0039	5535.96.00
81 46710 6836	4134.00.00	81 46711 6876	4096.00.00	82 46610 6080	5975.00.00
81 46710 6862	6792.00.00	81 46711 6877	4147.00.00	82 46610 6089	5975.00.00
81 46710 6863	6792.00.00	81 46711 6878	4147.00.00	82 46610 6090	5975.00.00
81 46710 6864	6792.00.00	81 46711 6879	4147.00.00	90 80415 3107	5741.10.00
81 46710 6875	4123.00.00	81 46711 6958	6791.00.00	90 80415 3111	5741.20.00
81 46710 6876	5933.00.00	81 95301 0013	5741.10.00	90 80415 3113	5741.10.00
81 46710 6877	5934.00.00	81 95301 0014	5741.20.00		
81 46710 6879	5934.00.00	81 95301 0015	5743.10.00		
81 46710 6881	4123.00.00	81 95301 0016	5743.20.00		
81 46710 6882	5933.00.00	81 95301 0064	5741.20.00		
81 46710 6908	5976.00.00	81 95301 0074	5741.10.00		
81 46710 6909	6792.00.00	81 95301 0083	5743.10.00		
81 46710 6910	6792.00.00	81 95301 0084	5743.20.00		
81 46710 6911	4134.00.00	81 95301 0087	5743.10.00		
81 46710 6912	4134.00.00	81 95301 6030	5743.10.00		
81 46710 6953	4134.00.00	81 95301 6043	5743.10.00		
81 46710 6974	6792.00.00	81 95301 6048	5743.20.00		
81 46711 6711	4132.00.00	81 95301 6049	5743.20.00		
81 46711 6712	6792.00.00	81 95301 6050	5743.10.00		
81 46711 6715	6791.00.00	81 95301 6053	5743.20.00		
81 46711 6723	5210.00.00	81 95301 6054	5743.10.00		
81 46711 6727	6193.00.00	81 95301 6067	5741.20.00		
81 46711 6732	6193.00.00	81 95301 6068	5741.10.00		
81 46711 6736	4134.00.00	81 95301 6087	5743.10.00		
81 46711 6747	4134.00.00	81 95301 6090	5743.20.00		
81 46711 6759	5934.00.00	81 95301 6091	5743.10.00		
81 46711 6760	5934.00.00	81 95301 6108	5743.20.00		
81 46711 6761	5934.00.00	81 95301 6112	5743.20.00		
81 46711 6763	5933.00.00	81 95301 6126	5743.20.00		
81 46711 6764	5933.00.00	81 95301 6143	5743.20.00		
81 46711 6765	4123.00.00	81 95301 6149	5743.20.00		
81 46711 6766	4123.00.00	81 95301 6154	5743.20.00		
81 46711 6767	4123.00.00	81 95301 6155	5743.10.00		
81 46711 6770	4096.00.00	81 95301 6156	5743.20.00		
81 46711 6771	4147.00.00	81 95301 6162	5741.20.00		
81 46711 6772	4096.00.00	81 95301 6163	5741.10.00		
81 46711 6778	6193.00.00	81 95301 6168	5743.10.00		
81 46711 6780	4147.00.00	81 95301 6178	5743.20.00		
81 46711 6782	4096.00.00	81 95301 6179	5743.10.00		
81 46711 6783	4096.00.00	81 95301 6194	5743.20.00		
81 46711 6785	4132.00.00	81 95301 6224	5743.20.00		

MERCEDES-BENZ/FAD

OEM	FAD		OEM	FAD		OEM	FAD
000 320 01 32	6890.00.00		001 330 67 35	5741.20.00		309 460 05 05	5775.00.00
000 320 02 32	6889.00.00		001 460 08 48	5743.20.00		309 460 08 05	5775.00.00
000 320 05 32	6890.00.00		001 460 12 48	5743.20.00		309 460 09 05	5775.00.00
000 320 06 32	6889.00.00		001 460 20 48	6050.10.00		309 460 10 05	5775.00.00
000 320 08 32	6890.00.00		001 460 21 48	6050.20.00		309 460 11 05	5775.00.00
000 320 09 32	6889.00.00		001 460 22 48	5743.20.00		309 460 12 05	5775.00.00
000 320 10 32	6889.00.00		001 460 37 48	5743.10.00		309 460 13 05	5775.00.00
000 320 11 32	6890.00.00		001 460 40 48	5741.10.00		309 460 14 05	5775.00.00
000 330 00 35	5741.10.00		001 460 41 48	5741.20.00		309 460 20 05	5775.00.00
000 330 00 75	3310.96.00		001 460 43 48	5741.10.00		309 460 22 05	5775.00.00
000 330 01 48	5741.10.00		001 460 44 48	5741.20.00		309 460 23 05	5775.00.00
000 330 02 48	5741.20.00		001 460 63 48	5741.20.00		309 460 24 05	5775.00.00
000 330 05 11	5128.96.00		001 460 64 48	5741.10.00		309 460 25 05	5775.00.00
000 330 07 07	5323.96.00		001 460 77 48	5743.20.00		309 460 26 05	5775.00.00
000 330 19 35	5848.10.00		001 460 78 48	5743.10.00		309 460 29 05	5775.00.00
000 330 20 11	4569.96.00		001 460 83 48	5741.20.00		309 460 29 05	5775.00.00
000 330 22 11	5128.96.00		001 460 84 48	5741.20.00		309 460 31 05	5775.00.00
000 330 29 35	5848.10.00		001 460 97 48	5741.20.00		310 330 04 35	5774.20.00
000 330 32 35	5741.20.00		002 330 15 35	5741.20.00		310 330 08 35	5774.20.00
000 330 40 35	5848.20.00		002 460 02 48	5741.10.00		310 330 13 35	5774.20.00
000 330 41 35	5848.10.00		002 460 03 48	5743.10.00		317 330 04 11	3609.38.00
000 330 49 29	5848.20.00		300 460 02 05	5875.00.00		317 350 06 06	3604.38.00
000 330 50 35	5774.20.00		300 460 03 05	5875.00.00		317 350 07 06	3602.38.00
000 330 77 35	5848.20.00		300 460 04 05	5835.00.00		322 330 10 11	3601.38.00
000 330 78 35	5848.10.00		300 460 05 05	5835.00.00		350 330 71 35	5741.10.00
000 338 34 10	5741.20.00		300 460 06 05	5283.00.00		356 330 00 03	6050.00.00
000 338 50 29	5848.10.00		300 460 07 05	5283.00.00		356 330 01 03	6054.00.00
000 350 05 06	5170.96.00		301 460 00 05	5875.00.00		356 330 02 03	6051.00.00
000 350 11 05	5705.96.00		301 460 01 05	5875.00.00		356 350 01 06	5708.00.00
000 460 03 48	5743.20.00		301 460 05 05	5835.00.00		356 463 00 15	6053.00.00
000 460 06 48	5743.10.00		302 330 00 35	5741.10.00		356 463 02 15	6052.00.00
000 460 12 48	5743.10.00		302 330 01 35	5741.10.00		357 330 00 35	5522.96.00
000 460 21 48	5774.20.00		302 330 02 35	5741.10.00		357 330 02 03	6817.00.00
000 460 28 48	5743.20.00		302 330 03 35	5741.10.00		357 330 04 03	6817.00.00
000 460 29 48	5743.20.00		302 330 09 03	5725.00.00		357 330 05 03	6817.00.00
000 460 34 48	5743.10.00		302 330 13 03	5725.00.00		357 330 06 03	5976.00.00
000 460 35 48	5743.10.00		302 330 15 03	5725.00.00		357 330 07 03	5976.00.00
000 460 41 48	5774.20.00		302 330 17 03	5725.00.00		357 330 11 03	6901.00.00
000 460 45 48	5774.20.00		305 330 04 03	6901.00.00		357 330 15 03	6901.00.00
000 460 77 48	6050.20.00		305 330 08 03	6901.00.00		357 330 17 11	3952.00.00
000 460 78 48	6050.10.00		305 330 10 03	6901.00.00		357 330 19 11	6910.00.00
000 460 83 48	5741.20.00		305 330 11 03	6901.00.00		357 330 31 11	3601.00.00
000 460 85 48	5774.20.00		305 460 03 05	5283.00.00		357 330 33 11	6910.00.00
000 463 34 29	5741.20.00		305 460 06 05	5887.00.00		357 330 34 11	3604.00.00
001 330 01 35	5741.20.00		307 330 01 11	3310.00.00		357 330 36 11	3310.00.00
001 330 02 35	5741.20.00		307 460 00 05	5843.00.00		357 330 42 11	3609.00.00
001 330 21 35	5848.20.00		307 460 04 05	5280.00.00		357 333 01 01	6059.00.00
001 330 22 35	5848.10.00		307 460 05 05	5843.00.00		357 333 04 05	6039.00.00
001 330 26 35	5848.20.00		309 460 03 05	5775.00.00		357 333 05 05	6905.00.00
001 330 27 35	5848.10.00		309 460 04 05	5775.00.00		357 333 06 05	4488.00.00



MERCEDES-BENZ/FAD

OEM	FAD		OEM	FAD		OEM	FAD
357 333 07 05	6906.00.00		629 330 00 03	4581.00.00			
357 333 09 05	4488.00.00		629 330 06 03	4581.00.00			
357 460 04 05	5865.00.00		629 350 05 06	6197.00.00			
357 460 10 05	5865.00.00		629 350 06 06	6197.00.00			
357 460 11 05	5865.00.00		629 350 12 06	4566.00.00			
357 460 12 05	5887.00.00		629 350 28 06	4566.00.00			
357 460 13 05	5887.00.00		632 320 03 32	6890.00.00			
357 460 14 05	3967.00.00		632 320 04 32	6889.00.00			
357 460 15 05	3967.00.00		632 330 01 03	4581.00.00			
357 460 32 05	6902.00.00		634 323 02 16	4586.00.00			
382 330 04 03	6155.00.00		634 323 03 16	4587.00.00			
600 330 01 11	3602.00.00		634 323 04 16	4586.00.00			
601 330 04 35	5886.20.00		634 323 05 16	4587.00.00			
601 330 05 35	5886.10.00		634 326 00 16	4588.00.00			
601 460 00 05	5775.00.00		634 326 01 16	4589.00.00			
601 460 01 05	5775.00.00		634 326 05 16	4588.00.00			
601 460 02 05	5775.00.00		634 326 06 16	4589.00.00			
601 460 03 05	5775.00.00		634 352 00 04	6156.00.00			
601 460 05 05	5852.00.00		634 352 00 05	6157.00.00			
601 460 06 05	5852.00.00		634 460 06 05	6154.00.00			
601 460 07 05	5852.00.00		644 350 03 05	6885.00.00			
601 460 08 05	5852.00.00		644 350 03 06	6913.00.00			
601 460 09 05	5852.00.00		667 460 15 05	4534.00.00			
601 460 10 05	5852.00.00		667 460 16 05	4573.00.00			
601 460 11 05	5852.00.00		667 460 17 05	4534.00.00			
601 460 12 05	5852.00.00		667 460 18 05	4573.00.00			
601 460 13 05	5852.00.00		671 333 02 05	6905.00.00			
601 460 15 05	5852.00.00		671 333 03 05	6158.00.00			
602 330 00 03	5886.00.00		671 333 04 05	6906.00.00			
602 330 01 03	5886.00.00		671 460 00 05	6900.00.00			
602 330 03 03	5886.00.00		671 460 02 05	6900.00.00			
602 330 52 03	5886.00.00		671 460 03 05	6902.00.00			
613 330 00 03	6050.00.00		901 460 01 48	1711.20.00			
613 463 00 15	6053.00.00,		901 460 03 48	1711.20.00			
628 320 01 89	6061.00.00						
628 320 03 89	6060.00.00						
628 330 00 03	6155.00.00						
628 330 01 03	6155.00.00						
628 330 04 03	6909.00.00						
628 330 05 03	6909.00.00						
628 333 00 03	6885.00.00						
628 333 00 05	6885.00.00						
628 333 01 05	6918.00.00						
628 333 09 05	6913.00.00						
628 333 10 05	6885.00.00						
628 333 17 05	6913.00.00						
628 333 18 05	6885.00.00						
628 460 03 05	4576.00.00						
628 460 12 05	4576.00.00						
628 460 20 05	4595.00.00						



RENAULT /FAD

OEM	FAD		OEM	FAD		OEM	FAD
00 03 401 170	5743.10.00						
00 03 406 169	5743.20.00						
00 03 406 212	5741.20.00						
00 03 406 218	5741.10.00						
00 03 406 236	5743.20.00						
00 03 406 251	5743.20.00						
00 03 406 253	5741.20.00						
00 03 406 254	5743.20.00						
00 03 406 260	5743.20.00						
00 03 406 261	5743.20.00						
50 00 242 159	5741.20.00						
50 00 288 360	5743.20.00						
50 00 288 361	5743.10.00						
50 00 295 214	5741.20.00						
50 00 295 215	5741.10.00						
50 00 590 236	5743.20.00						
50 00 761 671	4731.00.00						
50 00 804 824	5743.20.00						
50 00 812 483	5741.20.00						
50 00 819 365	5992.96.00						
50 01 832 581	5743.10.00						
50 01 832 582	5741.20.00						
50 01 834 533	5741.10.00						
50 01 850 549	5741.20.00						
50 01 850 550	5741.10.00						
50 01 852 263	5741.10.00						
50 01 858 773	5743.20.00						
50 01 858 774	5743.10.00						
50 01 859 984	5741.10.00						
50 01 859 985	5741.20.00						
50 10 104 286	4700.00.00						
50 10 104 287	4701.00.00						
50 10 104 465	5992.96.00						
50 10 151 528	4731.00.00						
50 10 197 399	3286.00.00						
50 10 207 724	4731.00.00						
50 10 207 725	4702.00.00						
50 10 207 726	3944.00.00						
50 10 207 727	3945.00.00						
50 10 207 728	4700.00.00						
50 10 207 729	4701.00.00						
50 10 207 771	3288.00.00						
50 10 393 015	4732.00.00						
77 01 011 412	5743.20.00						
77 01 016 946	5741.20.00						

SCANIA/FAD



OEM	FAD	OEM	FAD	OEM	FAD
1 101 843	6841.00.00	445 599	3361.00.00		
1 104 334	5323.96.00	445 626	6851.00.00		
1 104 335	5170.96.00	465 816	3362.00.00		
1 357 674	6832.20.00	466 801	3362.00.00		
1 358 792	5743.10.00	475 463	6834.00.00		
1 361 413	6832.00.00	477 889	4785.00.00		
1 379 423	6841.00.00	477 890	4779.00.00		
1 393 298	6841.00.00	481 690	4777.00.00		
1 394 443	7981.20.00	481 959	4782.00.00		
1 394 444	7982.20.00	483 527	6844.00.00		
1 395 614	6832.00.00	486 590	4787.00.00		
1 397 866	3126.00.00	488 056	4788.00.00		
1 431 471	4785.00.00	488 739	4784.00.00		
1 431 472	4779.00.00	489 987	3362.00.00		
1 431 475	4782.00.00	489 989	3361.00.00		
1 438 475	4792.00.00	550 806	5323.96.00		
1 455 327	6844.00.00	550 808	6409.96.00		
1 734 019	6832.00.00	621 863	3363.00.00		
1 734 020	3126.00.00	638 860	3363.96.00		
1 738 379	6832.20.00	638 861	5847.96.00		
1 738 380	5743.10.00.	638 862	5170.96.00		
1 738 381	5743.20.00	639 287	5170.96.00		
1 751 418	6844.00.00	639 370	5323.96.00		
1 766 015	6851.00.00	649 346	3364.00.00		
1 767 328	5743.20.00	651 156	3365.00.00		
1 770 732	4779.00.00				
1 789 082	6844.00.00				
1 796 671	3361.00.00				
1 863 130	4792.00.00				
1 897 333	6832.00.00				
1 897 671	4777.00.00				
1 897 673	6834.00.00				
1 914 426	5743.10.01				
1 914 427	5743.20.00				
1 928 859	6844.00.00				
1 942 075	6841.00.00				
1 953 248	5170.96.00				
2 028 998	3126.00.00				
2 040 254	6832.00.00				
2 051 165	5743.10.00.				
2 051 166	5743.20.00				
2 113 904	3126.00.00				
2 146 105	6832.00.00				
283 784	5743.10.02				
283 784	5743.20.00				
395 010	5743.10.00.				
395 010	5743.20.00				
395 350	3126.00.00				
434 493	4795.00.00				

VOLVO/FAD



OEM	FAD	OEM	FAD	OEM	FAD
1 075 255	5580.90.00	3 112 282	6281.00.00		
1 075 260	4256.00.00	3 116 050	4209.00.00		
1 082 104	6758.00.00	3 173 759	5580.90.00		
1 134 955	5388.90.00	382 745	6762.20.00		
1 135 080	5597.90.00	6 771 112	5140.00.00		
1 135 427	5599.00.00	6 869 744	7720.10.00		
1 135 429	6756.00.00	6 882 111	7720.20.00		
1 194 390	6753.00.00	6 889 480	7720.20.00		
1 197 338	5493.00.00	6 889 482	7720.20.00		
1 197 339	4252.00.00	70 308 561	6270.00.00		
1 507 826	7720.20.00	70 311 662	6274.00.00		
1 527 234	6762.20.00	70 311 664	6260.00.00		
1 589 817	5584.00.00	70 311 665	6273.00.00		
1 591 689	5580.90.00	70 371 272	6283.00.00		
1 598 588	5581.90.00	8 156 123	6754.00.00		
1 605 035	6758.00.00	8 365 399	6756.00.00		
1 629 072	4256.00.00	85 104 188	5494.20.00		
1 695 585	7720.20.00	85 104 265	6748.00.00		
1 695 776	7720.20.00	85 104 266	6263.10.00		
1 698 557	7720.20.00	85 104 274	6269.00.00		
1 698 558	7720.10.00	85 112 073	5596.20.00		
1 698 840	7720.10.00	85 114 146	7720.20.00		
20 443 063	6262.00.00	85 114 147	7720.10.00		
20 443 067	6262.00.00	85 114 167	6748.00.00		
20 453 121	4264.00.00	85 114 185	6731.00.00		
20 453 123	4264.00.00	85 114 240	6261.00.00		
20 490 123	5494.00.00	85 115 635	6274.00.00		
20 497 798	6261.00.00	85 125 126	5596.20.00		
20 497 799	6263.00.00	9 519 278	5494.00.00		
20 497 800	6731.00.00	9 523 794	6759.00.00		
20 539 988	6262.00.00	9 523 795	6755.00.00		
20 554 908	5580.90.00	9 959 151	6261.00.01		
20 739 082	6260.00.00	9 959 152	6263.00.00		
20 745 923	5494.00.00	9 959 153	6731.00.00		
20 994 420	6262.00.00	9 959 503	4237.00.00		
21 308 022	5494.00.00				
21 426 652	6274.00.00				
21 461 309	6283.00.00				
21 525 264	6274.00.00				
22 342 057	6272.00.00				
22 627 712	6274.00.00				
24 425 411	6272.00.00				
3 097 999	5494.20.00				
3 098 294	6748.00.00				
3 098 295	6263.10.00				
3 111 274	6269.00.00				
3 112 050	6261.00.00				
3 112 122	6731.00.00				
3 112 273	6263.00.00				
3 112 049	6270.00.00				



**Pregled uporednih oznaka
FAD / OEM**

**Cross references
FAD / OEM**



FAD/ IVECO, IRISBUS, IRIZAR

FAD	OEM	FAD	OEM	FAD	OEM
1480.20.00	9380 0662	6404.00.00	485 4871		
1480.20.00	9380 4059	6418.00.00	4103 6943		
1481.20.00	9380 2209	6425.20.00	4253 3101		
1481.20.00	9380 4060	6425.20.00	4253 3102		
4569.96.00	500 333 284	6426.20.00	9319 2809		
5103.00.00	9848 8010	6433.00.00	500 336 085		
5114.00.00	4212 5057	6433.00.00	9945 5009		
5114.00.00	471 4134	6439.00.00	4100 5450		
5114.00.00	9848 8010	6439.00.00	4100 5451		
5122.20.00	468 8941	6439.00.00	4103 6944		
5122.20.00	716 7757	6439.00.00	4104 2730		
5122.20.00	856 5366	6439.00.00	816 3773		
5122.20.00	858 2332	6445.00.00	504 113 827		
5148.00.00	857 0528	6445.00.00	5801 890 971		
5170.96.00	4248 8722	6446.00.00	504 113 824		
5741.10.00	298 0129				
5741.10.00	298 4511				
5741.10.00	4249 3782				
5741.10.00	483 3821				
5741.10.00	483 3826				
5741.10.00	483 3828				
5741.10.00	812 2755				
5741.20.00	298 0323				
5741.20.00	309 6213				
5741.20.00	4248 3520				
5741.20.00	4249 3781				
5741.20.00	59 4989 0760				
5743.10.00	298 4061				
5743.10.00	4248 9395				
5743.10.00	4248 9574				
5743.10.00	4249 1957				
5743.10.00	480 2444				
5743.10.00	483 3830				
5743.10.00	819 0225				
5743.20.00	296 6252				
5743.20.00	296 9808				
5743.20.00	4248 3386				
5743.20.00	4248 8269				
5743.20.00	4248 9573				
5743.20.00	4248 9594				
5743.20.00	4249 1638				
5743.20.00	480 2443				
5743.20.00	483 3829				
5743.20.00	812 2752				
5959.90.00	298 0884				
6344.00.00	9944 4744				
6344.00.00	9948 7779				
6395.00.00	9848 4091				
6402.00.00	500 307 556				
6402.00.00	9840 2553				



FAD/KÄSSBOHRER

FAD	OEM	FAD	OEM
3491.00.00	8.226.232.000	5742.20.00	6.851.488.000
3491.00.00	8.226.241.000	5742.20.00	6.851.523.000
3491.00.00	8.226.357.000	5743.10.00	6.851.485.000
3492.00.00	8.226.306.000	5743.10.00	8.226.236.058
3492.00.00	8.226.244.000 D	5743.20.00	6.851.475.000
3492.00.00	8.226.258.000 C	5743.20.00	6.851.480.000
3494.00.00	8.226.259.000	5743.20.00	6.851.484.000
3494.00.00	8.226.262.000	5743.20.00	6.851.531.000
3494.00.00	8.226.259.000 C	5743.20.00	8.226.236.059
3494.00.00	8.226.262.000 C	6040.00.00	8.226.249.000 C
3497.00.00	8.226.318.000 B	6041.00.00	8.226.250.000 C
3497.00.00	8.226.323.000 B	6041.00.00	8.226.250.0000
3581.10.00	6.851.490.000	6042.00.00	8.226.257.000
3581.20.00	6.851.491.000	6043.00.00	8.226.261.000 C
3590.20.00	8.321.999.319	6045.00.00	8.226.225.000 D
4576.00.00	6.284.600.305	6048.00.00	8.226.238.000 C
4911.00.00	8.226.308.000	6049.00.00	8.226.307.000
4911.00.00	8.226.381.000	6049.00.00	8.226.347.000
4911.00.00	8.226.248.000 C	6049.00.00	8.226.247.000 C
4911.00.00	8.226.308.000 C	6197.00.00	6.293.500.606
4911.20.00	68.515.290.000	6197.00.00	8.226.293.000B
4912.00.00	8.226.328.000	6909.00.00	628 330 05 03
4913.00.00	8.226.356.000		
4914.00.00	8.226.380.000		
4914.00.00	8.226.380.000 C		
4914.00.00	8.226.380.000.0		
4915.00.00	8.226.330.000		
4595.00.00	628 460 20 05		
4920.00.00	8.226.355.000		
4920.00.00	82.262.800.000		
4920.00.00	82.263.550.000		
4920.00.00	8.226.280.000 B		
4920.00.00	8.226.280.000 C		
5170.96.00	82 262 320 660		
5686.00.00	8.226.137.000		
5686.00.00	8.226.147.000 C		
5686.00.00	8.226.305.000 C		
5686.00.00	8.226.313.000 C		
5687.00.00	8.226.138.000		
5687.00.00	8.226.148.000 C		
5741.20.00	6.851.517.000		
5742.10.00	6.851.446.000		
5742.10.00	6.851.459.000		
5742.10.00	6.851.479.000		
5742.10.00	6.851.487.000		
5742.10.00	6.851.532.000		
5742.20.00	6.851.447.000		
5742.20.00	6.851.478.000		
5742.20.00	6.851.486.000		

FAD/MAN

FAD	OEM	FAD	OEM	FAD	OEM
3776.00.00	81 46710 6176	4134.00.00	81 46710 6836	5741.10.00	81 95301 0074
3776.00.00	81 46710 6340	4134.00.00	81 46710 6911	5741.10.00	81 95301 6068
3776.00.00	81 46710 6344	4134.00.00	81 46710 6912	5741.10.00	81 95301 6163
3776.00.00	81 46710 6422	4134.00.00	81 46710 6953	5741.10.00	81 95301 6361
3777.00.00	81 46710 6175	4134.00.00	81 46711 6736	5741.10.00	90 80415 3107
3777.00.00	81 46710 6242	4134.00.00	81 46711 6747	5741.10.00	90 80415 3113
3777.00.00	81 46710 6251	4134.00.00	81 46711 6830	5741.20.00	81 95301 0014
3777.00.00	81 46710 6420	4137.00.00	81 43250 6011	5741.20.00	81 95301 0064
4096.00.00	81 46711 6770	4137.00.00	81 43250 6016	5741.20.00	81 95301 6067
4096.00.00	81 46711 6772	4147.00.00	81 46711 6771	5741.20.00	81 95301 6162
4096.00.00	81 46711 6782	4147.00.00	81 46711 6780	5741.20.00	81 95301 6239
4096.00.00	81 46711 6783	4147.00.00	81 46711 6877	5741.20.00	81 95301 6360
4096.00.00	81 46711 6874	4147.00.00	81 46711 6878	5741.20.00	90 80415 3111
4096.00.00	81 46711 6875	4147.00.00	81 46711 6879	5743.10.00	81 95301 0015
4096.00.00	81 46711 6876	5170.96.00	81 43220 6055	5743.10.00	81 95301 0083
4097.00.00	81 46610 6606	5170/96/00	81 43220 6073	5743.10.00	81 95301 0087
4104.00.00	81 46710 6117	5210.00.00	81 46710 6236	5743.10.00	81 95301 6030
4104.00.00	81 46710 6281	5210.00.00	81 46710 6267	5743.10.00	81 95301 6043
4104.00.00	81 46710 6282	5210.00.00	81 46710 6268	5743.10.00	81 95301 6050
4104.00.00	81 46710 6370	5210.00.00	81 46710 6355	5743.10.00	81 95301 6054
4104.00.00	81 46710 6371	5210.00.00	81 46710 6356	5743.10.00	81 95301 6087
4104.00.00	81 46710 6372	5210.00.00	81 46710 6373	5743.10.00	81 95301 6091
4107.00.00	81 43220 6144	5210.00.00	81 46711 6723	5743.10.00	81 95301 6155
4107.00.00	81 43220 6189	5235.00.00	81 46610 6292	5743.10.00	81 95301 6168
4107.00.00	81 43220 6210	5235.00.00	81 46610 6424	5743.10.00	81 95301 6179
4107.00.00	81 43220 6211	5235.00.00	81 46610 6432	5743.10.00	81 95301 6237
4107.00.00	81 43220 6396	5235.00.00	81 46610 6434	5743.10.00	81 95301 6279
4107.00.00	81 43220 6409	5235.00.00	81 46610 6437	5743.20.00	81 95301 0016
4108.00.00	81 43220 6161	5235.00.00	81 46610 6513	5743.20.00	81 95301 0084
4108.00.00	81 43220 6190	5235.00.00	81 46610 6537	5743.20.00	81 95301 6048
4108.00.00	81 43220 6397	5235.00.00	81 46610 6596	5743.20.00	81 95301 6049
4123.00.00	81 46710 6453	5235.00.00	81 46610 6614	5743.20.00	81 95301 6053
4123.00.00	81 46710 6457	5235.00.00	81 46610 6635	5743.20.00	81 95301 6090
4123.00.00	81 46710 6458	5235.00.00	81 46610 6735	5743.20.00	81 95301 6108
4123.00.00	81 46710 6875	5235.00.00	81 46610 6743	5743.20.00	81 95301 6112
4123.00.00	81 46710 6881	5235.00.00	81 46611 6051	5743.20.00	81 95301 6126
4123.00.00	81 46711 6765	5235.00.00	81 46611 6052	5743.20.00	81 95301 6143
4123.00.00	81 46711 6766	5339.00.00	81 43220 6168	5743.20.00	81 95301 6149
4123.00.00	81 46711 6767	5522.00.00	81 43718 6006	5743.20.00	81 95301 6154
4132.00.00	81 46711 6711	5522.00.00	81 43718 6007	5743.20.00	81 95301 6156
4132.00.00	81 46711 6785	5522.96.00	81 43718 6009	5743.20.00	81 95301 6178
4132.00.00	81 46711 6846	5535.00.00	81 43315 6012	5743.20.00	81 95301 6194
4134.00.00	81 46710 6122	5535.96.00	81 95302 0039	5743.20.00	81 95301 6224
4134.00.00	81 46710 6167	5537.00.00	81 43230 6037	5743.20.00	81 95301 6234
4134.00.00	81 46710 6194	5537.00.00	81 43230 9037	5743.20.00	81 95301 6274
4134.00.00	81 46710 6195	5538.00.00	81 43220 6102	5932.00.00	81 46610 6196
4134.00.00	81 46710 6378	5538.00.00	81 43220 6148	5932.00.00	81 46610 6202
4134.00.00	81 46710 6379	5538.00.00	81 43220 6152	5932.00.00	81 46610 6258
4134.00.00	81 46710 6380	5538.00.00	81 43220 6186	5932.00.00	81 46610 6409
4134.00.00	81 46710 6830	5741.10.00	81 95301 0013	5932.00.00	81 46610 6504

FAD/MAN



FAD	OEM	FAD	OEM	FAD	OEM
5932.00.00	81 46610 6531	5975.00.00	82 46610 6090	6791.00.00	81 46711 6715
5932.00.00	81 46610 6593	5976.00.00	81 46710 6459	6791.00.00	81 46711 6823
5932.00.00	81 46610 6609	5976.00.00	81 46710 6806	6791.00.00	81 46711 6842
5932.00.00	81 46610 6631	5976.00.00	81 46710 6818	6791.00.00	81 46711 6958
5932.00.00	81 46610 6740	5976.00.00	81 46710 6819	6792.00.00	81 46710 6862
5933.00.00	81 46710 6080	5976.00.00	81 46710 6908	6792.00.00	81 46710 6863
5933.00.00	81 46710 6136	6191.00.00	81 43220 6174	6792.00.00	81 46710 6864
5933.00.00	81 46710 6172	6193.00.00	81 46711 6727	6792.00.00	81 46710 6909
5933.00.00	81 46710 6295	6193.00.00	81 46711 6732	6792.00.00	81 46710 6910
5933.00.00	81 46710 6337	6193.00.00	81 46711 6778	6792.00.00	81 46710 6974
5933.00.00	81 46710 6345	6193.00.00	81 46711 6844	6792.00.00	81 46711 6712
5933.00.00	81 46710 6421	6194.00.00	81 43220 6151	6792.00.00	81 46711 6845
5933.00.00	81 46710 6451	6194.00.00	81 43220 6183		
5933.00.00	81 46710 6876	6194.00.00	81 43220 6276		
5933.00.00	81 46710 6882	6194.00.00	81 43220 6277		
5933.00.00	81 46711 6763	6194.00.00	81 43220 6390		
5933.00.00	81 46711 6764	6198.00.00	81 46610 6708		
5934.00.00	81 46710 6081	6198.00.00	81 46611 6067		
5934.00.00	81 46710 6137	6202.00.00	81 46610 6716		
5934.00.00	81 46710 6173	6202.00.00	81 46611 6068		
5934.00.00	81 46710 6294	6203.00.00	81 46610 6689		
5934.00.00	81 46710 6419	6203.00.00	81 46610 6720		
5934.00.00	81 46710 6444	6203.00.00	81 46610 6721		
5934.00.00	81 46710 6761	6206.00.00	81 46610 6376		
5934.00.00	81 46710 6877	6211.00.00	81 46610 6756		
5934.00.00	81 46710 6879	6325.00.00	81 46610 6803		
5934.00.00	81 46711 6759	6681.00.00	81 46610 6648		
5934.00.00	81 46711 6760	6681.00.00	81 46611 6150		
5934.00.00	81 46711 6761	6683.00.00	81 43220 6258		
5946.00.00	81 46610 6147	6683.00.00	81 43220 6264		
5946.00.00	81 46610 6194	6683.00.00	81 43220 6275		
5946.00.00	81 46610 6195	6683.00.00	81 43220 6278		
5946.00.00	81 46610 6201	6683.00.00	81 43220 6279		
5946.00.00	81 46610 6257	6683.00.00	81 43220 6391		
5946.00.00	81 46610 6415	6687.00.00	81 46611 6131		
5946.00.00	81 46610 6476	6688.00.00	81 46611 6108		
5946.00.00	81 46610 6503	6688.00.00	81 46611 6120		
5946.00.00	81 46610 6532	6688.00.00	81 46611 6125		
5946.00.00	81 46610 6608	6688.00.00	81 46611 6129		
5946.00.00	81 46610 6630	6689.00.00	81 46610 6795		
5948.00.00	81 43220 6025	6689.00.00	81 46611 6045		
5951.00.00	81 43220 6042	6689.00.00	81 46611 6047		
5952.00.00	81 43220 6043	6689.00.00	81 46611 6049		
5956.00.00	81 43220 6099	6689.00.00	81 46611 6115		
5956.00.00	81 43220 6100	6689.00.00	81 46611 6126		
5959.90.00	81 43220 6108	6691.00.00	81 46610 6548		
5975.00.00	81 46610 6374	6691.00.00	81 46611 6065		
5975.00.00	81 46611 6019	6698.00.00	36 46710 6003		
5975.00.00	82 46610 6080	6698.00.00	36 46710 6005		
5975.00.00	82 46610 6089	6699.00.00	36 46610 6000		



FAD/MERCEDES-BENZ

FAD	OEM	FAD	OEM	FAD	OEM
1711.20.00	901 460 01 48	5725.00.00	302 330 09 03	5774.20.00	310 330 08 35
1711.20.00	901 460 03 48	5725.00.00	302 330 13 03	5774.20.00	310 330 13 35
3310.00.00	307 330 01 11	5725.00.00	302 330 15 03	5775.00.00	309 460 31 05
3310.00.00	357 330 36 11	5725.00.00	302 330 17 03	5775.00.00	309 460 03 05
3310.96.00	000 330 00 75	5741.10.00	000 330 00 35	5775.00.00	309 460 04 05
3601.00.00	357 330 31 11	5741.10.00	000 330 01 48	5775.00.00	309 460 05 05
3601.38.00	322 330 10 11	5741.10.00	001 460 40 48	5775.00.00	309 460 08 05
3602.00.0	600 330 01 11	5741.10.00	001 460 43 48	5775.00.00	309 460 09 05
3602.38.00	317 350 07 06	5741.10.00	001 460 64 48	5775.00.00	309 460 10 05
3604.00.00	357 330 34 11	5741.10.00	302 330 00 35	5775.00.00	309 460 11 05
3604.38.00	317 350 06 06	5741.10.00	302 330 01 35	5775.00.00	309 460 12 05
3609.00.00	357 330 42 11	5741.10.00	302 330 02 35	5775.00.00	309 460 13 05
3609.38.00	317 330 04 11	5741.10.00	302 330 03 35	5775.00.00	309 460 14 05
3952.00.00	357 330 17 11	5741.10.00	350 330 71 35	5775.00.00	309 460 20 05
3967.00.00	357 460 14 05	5741.10.00	002 460 02 48	5775.00.00	309 460 22 05
3967.00.00	357 460 15 05	5741.20.00	000 330 02 48	5775.00.00	309 460 23 05
4488.00.00	357 333 06 05	5741.20.00	000 330 32 35	5775.00.00	309 460 24 05
4488.00.00	357 333 09 05	5741.20.00	000 338 34 10	5775.00.00	309 460 25 05
4534.00.00	667 460 15 05	5741.20.00	000 460 83 48	5775.00.00	309 460 26 05
4534.00.00	667 460 17 05	5741.20.00	000 463 34 29	5775.00.00	309 460 29 05
4566.00.00	629 350 12 06	5741.20.00	001 330 01 35	5775.00.00	309 460 29 05
4566.00.00	629 350 28 06	5741.20.00	001 330 02 35	5775.00.00	601 460 00 05
4569.96.00	000 330 20 11	5741.20.00	001 330 67 35	5775.00.00	601 460 01 05
4573.00.00	667 460 16 05	5741.20.00	001 460 41 48	5775.00.00	601 460 02 05
4573.00.00	667 460 18 05	5741.20.00	001 460 44 48	5775.00.00	601 460 03 05
4576.00.00	628 460 03 05	5741.20.00	001 460 63 48	5835.00.00	300 460 04 05
4576.00.00	628 460 12 05	5741.20.00	001 460 83 48	5835.00.00	300 460 05 05
4581.00.00	629 330 00 03	5741.20.00	001 460 84 48	5835.00.00	301 460 05 05
4581.00.00	629 330 06 03	5741.20.00	001 460 97 48	5843.00.00	307 460 00 05
4581.00.00	632 330 01 03	5741.20.00	002 330 15 35	5843.00.00	307 460 05 05
4586.00.00	634 323 02 16	5743.10.00	000 460 06 48	5848.10.00	000 330 19 35
4586.00.00	634 323 04 16	5743.10.00	000 460 12 48	5848.10.00	000 330 29 35
4587.00.00	634 323 03 16	5743.10.00	000 460 34 48	5848.10.00	000 330 41 35
4587.00.00	634 323 05 16	5743.10.00	000 460 35 48	5848.10.00	000 330 78 35
4588.00.00	634 326 00 16	5743.10.00	001 460 37 48	5848.10.00	000 338 50 29
4588.00.00	634 326 05 16	5743.10.00	001 460 78 48	5848.10.00	001 330 22 35
4589.00.00	634 326 01 16	5743.10.00	002 460 03 48	5848.10.00	001 330 27 35
4589.00.00	634 326 06 16	5743.20.00	000 460 03 48	5848.20.00	000 330 40 35
4595.00.00	628 460 20 05	5743.20.00	000 460 28 48	5848.20.00	000 330 49 29
5128.96.00	000 330 05 11	5743.20.00	000 460 29 48	5848.20.00	000 330 77 35
5128.96.00	000 330 22 11	5743.20.00	001 460 08 48	5848.20.00	001 330 21 35
5170.96.00	000 350 05 06	5743.20.00	001 460 12 48	5848.20.00	001 330 26 35
5280.00.00	307 460 04 05	5743.20.00	001 460 22 48	5852.00.00	601 460 05 05
5283.00.00	300 460 06 05	5743.20.00	001 460 77 48	5852.00.00	601 460 06 05
5283.00.00	300 460 07 05	5774.20.00	000 330 50 35	5852.00.00	601 460 07 05
5283.00.00	305 460 03 05	5774.20.00	000 460 21 48	5852.00.00	601 460 08 05
5323.96.00	000 330 07 07	5774.20.00	000 460 41 48	5852.00.00	601 460 09 05
5522.96.00	357 330 00 35	5774.20.00	000 460 45 48	5852.00.00	601 460 10 05
5705.96.00	000 350 11 05	5774.20.00	000 460 85 48	5852.00.00	601 460 11 05
5708.00.00	356 350 01 06	5774.20.00	310 330 04 35	5852.00.00	601 460 12 05



FAD/MERCEDES-BENZ

FAD	OEM	FAD	OEM	FAD	OEM
5852.00.00	601 460 13 05	6890.00.00	000 320 01 32		
5852.00.00	601 460 15 05	6890.00.00	000 320 05 32		
5865.00.00	357 460 04 05	6890.00.00	000 320 08 32		
5865.00.00	357 460 10 05	6890.00.00	000 320 11 32		
5865.00.00	357 460 11 05	6890.00.00	632 320 03 32		
5875.00.00	300 460 02 05	6900.00.00	671 460 00 05		
5875.00.00	300 460 03 05	6900.00.00	671 460 02 05		
5875.00.00	301 460 00 05	6901.00.00	305 330 04 03		
5875.00.00	301 460 01 05	6901.00.00	305 330 08 03		
5886.00.00	602 330 00 03	6901.00.00	305 330 10 03		
5886.00.00	602 330 01 03	6901.00.00	305 330 11 03		
5886.00.00	602 330 03 03	6901.00.00	357 330 11 03		
5886.00.00	602 330 52 03	6901.00.00	357 330 15 03		
5886.10.00	601 330 05 35	6902..00.00	671 460 03 05		
5886.20.00	601 330 04 35	6902.00.00	357 460 32 05		
5887.00.00	305 460 06 05	6905.00.00	357 333 05 05		
5887.00.00	357 460 12 05	6905.00.00	671 333 02 05		
5887.00.00	357 460 13 05	6906.00.00	357 333 07 05		
5976.00.00	357 330 06 03	6906.00.00	671 333 04 05		
5976.00.00	357 330 07 03	6909.00.00	628 330 04 03		
6039.00.00	357 333 04 05	6909.00.00	628 330 05 03		
6050.00.00	356 330 00 03	6910.00.00	357 330 19 11		
6050.00.00	613 330 00 03	6910.00.00	357 330 33 11		
6050.10.00	000 460 78 48	6913.00.00	628 333 09 05		
6050.10.00	001 460 20 48	6913.00.00	628 333 17 05		
6050.20.00	000 460 77 48	6913.00.00	644 350 03 06		
6050.20.00	001 460 21 48	6918.00.00	628 333 01 05		
6051.00.00	356 330 02 03				
6052.00.00	356 463 02 15				
6053.00.00	356 463 00 15				
6053.00.00,	613 463 00 15				
6054.00.00	356 330 01 03				
6059.00.00	357 333 01 01				
6060.00.00	628 320 03 89				
6061.00.00	628 320 01 89				
6197.00.00	629 350 05 06				
6197.00.00	629 350 06 06				
6817.00.00	357 330 02 03				
6817.00.00	357 330 04 03				
6817.00.00	357 330 05 03				
6885.00.00	628 333 00 03				
6885.00.00	628 333 00 05				
6885.00.00	628 333 10 05				
6885.00.00	628 333 18 05				
6885.00.00	644 350 03 05				
6889.00.00	000 320 02 32				
6889.00.00	000 320 06 32				
6889.00.00	000 320 09 32				
6889.00.00	000 320 10 32				
6889.00.00	632 320 04 32				



FAD/RENAULT

FAD	OEM		FAD	OEM		FAD	OEM
3286.00.00	50 10 197 399						
3288.00.00	50 10 207 771						
3944.00.00	50 10 207 726						
3945.00.00	50 10 207 727						
4700.00.00	50 10 104 286						
4700.00.00	50 10 207 728						
4701.00.00	50 10 104 287						
4701.00.00	50 10 207 729						
4702.00.00	50 10 207 725						
4731.00.00	50 00 761 671						
4731.00.00	50 10 151 528						
4731.00.00	50 10 207 724						
4732.00.00	50 10 393 015						
5741.10.00	00 03 406 218						
5741.10.00	50 00 295 215						
5741.10.00	50 01 834 533						
5741.10.00	50 01 850 550						
5741.10.00	50 01 852 263						
5741.10.00	50 01 859 984						
5741.20.00	00 03 406 212						
5741.20.00	00 03 406 253						
5741.20.00	50 00 242 159						
5741.20.00	50 00 295 214						
5741.20.00	50 00 812 483						
5741.20.00	50 01 832 582						
5741.20.00	50 01 850 549						
5741.20.00	50 01 859 985						
5741.20.00	77 01 016 946						
5743.10.00	00 03 401 170						
5743.10.00	50 00 288 361						
5743.10.00	50 01 832 581						
5743.10.00	50 01 858 774						
5743.20.00	00 03 406 169						
5743.20.00	00 03 406 236						
5743.20.00	00 03 406 251						
5743.20.00	00 03 406 254						
5743.20.00	00 03 406 260						
5743.20.00	00 03 406 261						
5743.20.00	50 00 288 360						
5743.20.00	50 00 590 236						
5743.20.00	50 00 804 824						
5743.20.00	50 01 858 773						
5743.20.00	77 01 011 412						
5992.96.00	50 00 819 365						
5992.96.00	50 10 104 465						



FAD/SCANIA

FAD	OEM	FAD	OEM	FAD	OEM
3126.00.00	1 397 866	6409.96.00	550 808		
3126.00.00	1 734 020	6832.00.00	1 361 413		
3126.00.00	2 028 998	6832.00.00	1 395 614		
3126.00.00	2 113 904	6832.00.00	1 734 019		
3126.00.00	395 350	6832.00.00	1 897 333		
3361.00.00	1 796 671	6832.00.00	2 040 254		
3361.00.00	445 599	6832.00.00	2 146 105		
3361.00.00	489 989	6832.20.00	1 357 674		
3362.00.00	465 816	6832.20.00	1 738 379		
3362.00.00	466 801	6834.00.00	1 897 673		
3362.00.00	489 987	6834.00.00	475 463		
3363.00.00	621 863	6841.00.00	1 101 843		
3363.96.00	638 860	6841.00.00	1 379 423		
3364.00.00	649 346	6841.00.00	1 393 298		
3365.00.00	651 156	6841.00.00	1 942 075		
4777.00.00	1 897 671	6844.00.00	1 455 327		
4777.00.00	481 690	6844.00.00	1 751 418		
4779.00.00	1 431 472	6844.00.00	1 789 082		
4779.00.00	1 770 732	6844.00.00	1 928 859		
4779.00.00	477 890	6844.00.00	483 527		
4782.00.00	1 431 475	6851.00.00	1 766 015		
4782.00.00	481 959	6851.00.00	445 626		
4784.00.00	488 739	7981.20.00	1 394 443		
4785.00.00	1 431 471	7982.20.00	1 394 444		
4785.00.00	477 889				
4787.00.00	486 590				
4788.00.00	488 056				
4792.00.00	1 438 475				
4792.00.00	1 863 130				
4795.00.00	434 493				
5170.96.00	1 104 335				
5170.96.00	1 953 248				
5170.96.00	638 862				
5170.96.00	639 287				
5323.96.00	1 104 334				
5323.96.00	550 806				
5323.96.00	639 370				
5743.10.00	1 358 792				
5743.10.00.	1 738 380				
5743.10.00.	2 051 165				
5743.10.00.	395 010				
5743.10.01	1 914 426				
5743.10.02	283 784				
5743.20.00	1 738 381				
5743.20.00	1 767 328				
5743.20.00	1 914 427				
5743.20.00	2 051 166				
5743.20.00	283 784				
5743.20.00	395 010				
5847.96.00	638 861				

FAD/VOLVO



FAD	OEM	FAD	OEM	FAD	OEM
4209.00.00	3 116 050	6283.00.00	21 461 309		
4237.00.00	9 959 503	6283.00.00	70 371 272		
4252.00.00	1 197 339	6269.00.00	3 111 274		
4256.00.00	1 075 260	6269.00.00	85 104 649		
4256.00.00	1 629 072	6270.00.00	3 112 049		
4264.00.00	20 453 121	6270.00.00	70 308 561		
4264.00.00	20 453 123	6731.00.00	20 497 800		
5140.00.00	6 771 112	6731.00.00	3 112 122		
5388.90.00	1 134 955	6731.00.00	85 114 185		
5493.00.00	1 197 338	6731.00.00	9 959 153		
5494.00.00	20 490 123	6748.00.00	3 098 294		
5494.00.00	20 745 923	6748.00.00	85 104 265		
5494.00.00	21 308 022	6748.00.00	85 114 167		
5494.00.00	9 519 278	6753.00.00	1 194 390		
5494.20.00	3 097 999	6754.00.00	8 156 123		
5494.20.00	85 104 188	6755.00.00	9 523 795		
5580.90.00	1 075 255	6756.00.00	1 135 429		
5580.90.00	1 591 689	6756.00.00	8 365 399		
5580.90.00	20 554 908	6758.00.00	1 082 104		
5580.90.00	3 173 759	6758.00.00	1 605 035		
5581.90.00	1 598 588	6759.00.00	9 523 794		
5584.00.00	1 589 817	6762.20.00	1 527 234		
5596.20.00	85 112 073	6762.20.00	382 745		
5596.20.00	85 125 126	7720.10.00	1 698 558		
5597.90.00	1 135 080	7720.10.00	1 698 840		
5599.00.00	1 135 427	7720.10.00	6 869 744		
6260.00.00	20 739 082	7720.10.00	85 114 147		
6260.00.00	70 311 664	7720.20.00	1 507 826		
6261,00,00	85 114 240	7720.20.00	1 695 585		
6261.00.00	20 497 798	7720.20.00	1 695 776		
6261.00.00	3 112 050	7720.20.00	1 698 557		
6261.00.01	9 959 151	7720.20.00	6 882 111		
6262.00.00	20 443 063	7720.20.00	6 889 480		
6262.00.00	20 443 067	7720.20.00	6 889 482		
6262.00.00	20 539 988	7720.20.00	85 114 146		
6262.00.00	20 994 420				
6263.00.00	20 497 799				
6263.00.00	3 112 273				
6263.00.00	9 959 152				
6263.10.00	3 098 295				
6263.10.00	85 104 266				
6272.00.00	22 342 057				
6272.00.00	24 425 411				
6273.00.00	70 311 665				
6274.00.00	21 426 652				
6274.00.00	21 525 264				
6274.00.00	22 627 712				
6274.00.00	70 311 662				
6274.00.00	85 115 635				
6281.00.00	3 112 282				