

**FAD**

**KATALOG PROIZVODA  
PRODUCT CATALOGUE  
WARENKATALOG**

# CERTIFICATE

Quality Austria Trainings-, Zertifizierungs- und Begutachtungs GmbH awards this **qualityaustria** certificate to the following organisation:

This **qualityaustria** certificate confirms the application and further development of an effective



**METALAC FAD d.o.o.**

RS-32300 Gornji Milanovac, Kneza Aleksandra 210

**QUALITY MANAGEMENT SYSTEM**

complying with the requirements of standard  
**ISO 9001:2008**

Quality Austria Trainings-, Zertifizierungs- und Begutachtungs GmbH is accredited according to the Austrian Accreditation Act by the BMWF/W (Federal Ministry of Science, Research and Economy).

Quality Austria is accredited as an organisation for environmental verification by the BMLFUW (Federal Ministry of Agriculture, Forestry, Environment and Water Management).

Quality Austria is authorized by the VDA (Association of the Automotive Industry).

For accreditation registration details please refer to the applicable decisions or recognition documents.

Quality Austria is the Austrian member of IQNet (International Certification Network).

Dok. Nr. FO\_24\_058

08-069333e-3eef-4838-976-17062669628b

The current validity of the certificate is documented exclusively on the Internet under <http://www.qualityaustria.com/en/cert> EAC: 22.1

Steering and suspension parts production

Registration No.: 08606/0

Date of initial issue: 25 November 2009

Valid until: 14 September 2018



 **qualityaustria**



Vienna, 28 October 2015

Quality Austria Trainings-, Zertifizierungs- und Begutachtungs GmbH,  
A-1010 Vienna, Zelinkagasse 10/3

Signatures removed for security reasons

Konrad Scheiber  
General Manager

Dr. Mag. Anni Koubek  
Specialist representative



# CERTIFICATE

Quality Austria Trainings-, Zertifizierungs- und Begutachtungs GmbH awards this **qualityaustria** certificate to the following organisation:

This **qualityaustria** certificate confirms the application and further development of an effective

**METALAC FAD d.o.o.**

RS-32300 Gornji Milanovac, Kneza Aleksandra 210

**QUALITY MANAGEMENT SYSTEM**

complying with the requirements of standard  
**ISO/TS 16949:2009**  
without product design

Steering and suspension parts production

Registration No.: 01572/0

IATF-Registration No.: 0222452

Issue Date: 28 October 2015

Expiration Date: 14 September 2018

Vienna, 28 October 2015

Quality Austria Trainings-, Zertifizierungs- und Begutachtungs GmbH,  
A-1010 Vienna, Zelinkagasse 10/3

Signatures removed for security reasons

Konrad Scheiber  
General Manager

Ing. Michael Dragosits, MSc  
Specialist representative

Page 1 / 1

# **SADRŽAJ**

## **CONTENT**

### **INHALT**

#### **KAMIONI I AUTOBUSI / TRUCKS AND BUSES / LKW UND BUSSE**

OBJAŠNJENJE/EXPLANATION/ERKLÄRUNG	1
DAF	5
IVECO	20
KÄSSBOHRER	38
LIEBHERR	44
MAN	48
MERCEDES-BENZ	80
RABA	148
RENAULT	155
SCANIA	176
VOLVO	190
CROSS. REF. OEM / FAD	215
CROSS. REF. FAD / OEM	240

**UPUTSTVO**  
**ERKLÄRUNG**  
**EXPLANATION**

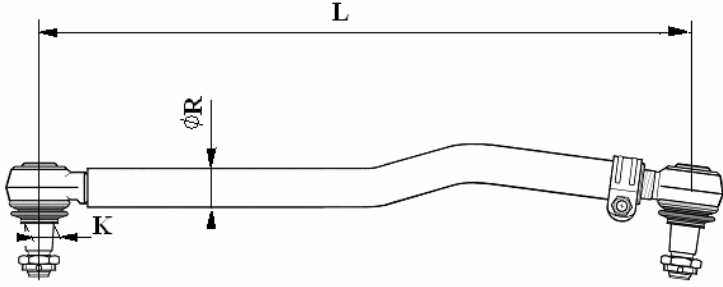
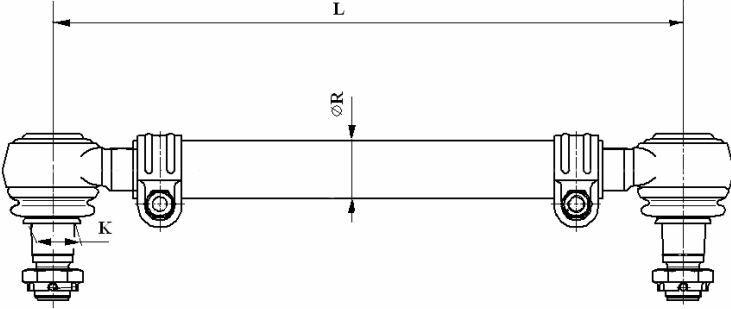
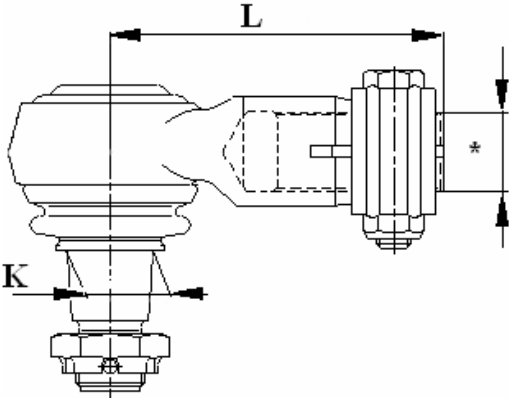

Skica Benennung Description	Simbol Symbole Symbols	Objasnjenje Erklärung Explanation
<p><b>Spona upravljava</b>  <b>Lenkstange</b>  <b>Drag link</b></p> 	<p>Kugla Ball Ø Größe</p> <p>ØR</p> <p>L</p> <p>K</p>	<p>-Precnik kugle Kugel-Durchmesser Ball pin diameter</p> <p>-Precnik cevi Rohr durchmesser Tube diameter</p> <p>-Duzina spone Längenmass von mitte bis mitte Distance center to center distance</p> <p>-Max. precnik konusa Größtmass am konus Taper Ø max. size</p>
<p><b>Poprecna spona</b>  <b>Spurstange</b>  <b>Tie rod</b></p> 	<p>Kugla Ball Ø Größe</p> <p>ØR</p> <p>L</p> <p>K</p>	<p>-Precnik kugle Kugel-Durchmesser Ball pin diameter</p> <p>-Precnik cevi Rohr durchmesser Tube diameter</p> <p>-Duzina spone Längenmass von mitte bis mitte Distance center to center distance</p> <p>-Max. precnik konusa Größtmass am konus Taper Ø max. size</p>
<p><b>Zglob sa untrasnjim navojem</b>  <b>Kugelgelenk</b>  <b>Tie rod end</b></p> 	<p>Kugla Ball Ø Größe</p> <p>L</p> <p>K</p> <p>*</p>	<p>-Precnik kugle Kugel-Durchmesser Ball pin diameter</p> <p>-Duzina zgloba Kugelgelenk länge Tie rod end lenght</p> <p>-Max. precnik konusa Größtmass am konus Taper Ø max. size</p> <p>-Untrasnji navoj Innengewinde Internal thread</p>

**UPUTSTVO**  
**ERKLÄRUNG**  
**EXPLANATION**



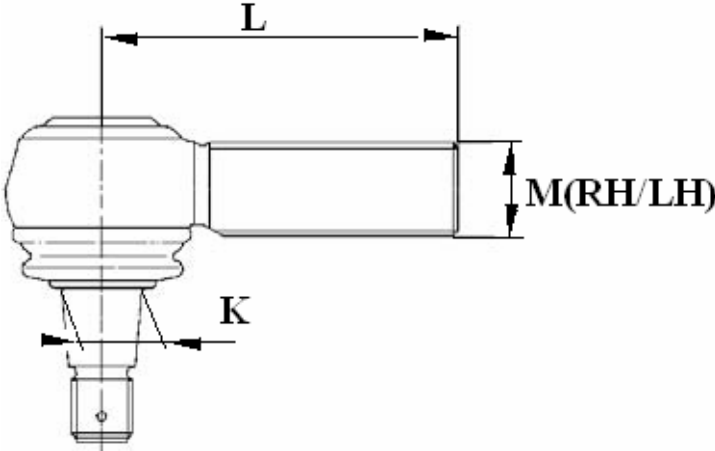
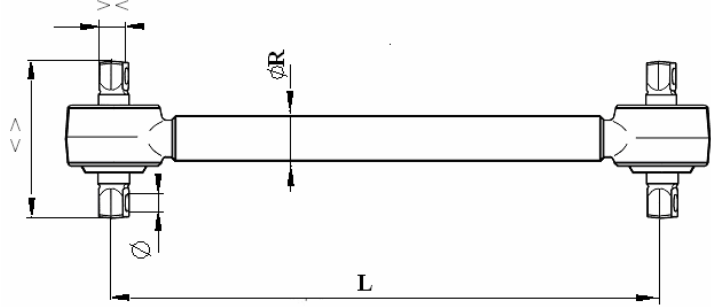

Skica Benennung Description	Simbol Symbole Symbols	Objasnjenje Erklärung Explanation
<p><b>Zglob</b>  <b>Kugelgelenk</b>  <b>Tie rod end</b></p> 	<p>Kugla Ball Ø Größe</p> <p>L</p> <p>K</p> <p>M</p> <p>RH</p> <p>LH</p>	<p>-Prečnik kugle Kugel-Durchmesser Ball pin diameter</p> <p>-Duzina zgloba Kugelgelenk länge Tie rod end lenght</p> <p>-Max. prečnik konusa Größtmass am konus Taper Ø max. size</p> <p>-Metricki navoj Metrisches gewinde ISO Thread-metrie</p> <p>-Desni navoj Rechtsgewinde Right hand thread</p> <p>-Levi navoj Linksgewinde Left hand thread</p>
<p><b>Vodjica mosta</b>  <b>Achsstrebe</b>  <b>Torque rod</b></p> 	<p>Kugla Ball Ø Größe</p> <p>ØR</p> <p>L</p> <p>Ø</p> <p>&gt; &lt;</p> <p>&lt; &gt;</p>	<p>-Prečnik kugle Kugel-Durchmesser Ball pin diameter</p> <p>-Prečnik cevi Rohr durchmesser Tube diameter</p> <p>-Duzina vodjice mosta Längenmass von mitte bis mitte Distance center to center distance</p> <p>-Prečnik otvora Bohrungs-durchmesser Bore Ø</p> <p>-Debljina flaha Breite Broad</p> <p>-Rastojanje izmedju otvora Lochabstand Hole distance</p>

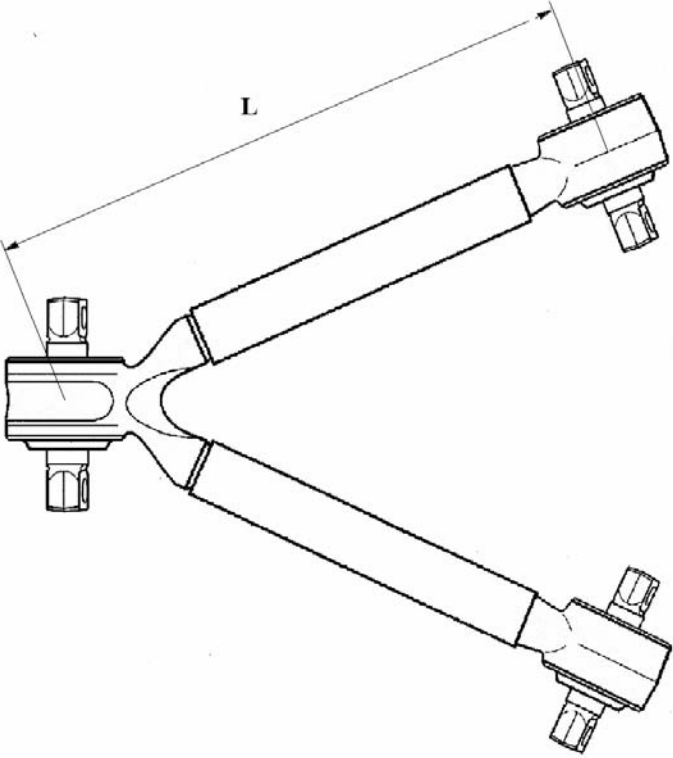
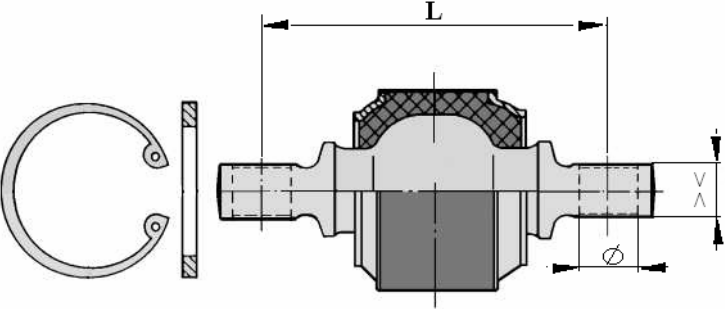
**UPUTSTVO**  
**ERKLÄRUNG**  
**EXPLANATION**

Skica Benennung Description	Simbol Symbole Symbols	Objasnjenje Erklärung Explanation
<p><b>V-vodjica mosta</b>  <b>Dreieckslenker</b>  <b>Triangular torque rod</b></p> 	<p>Kugla                  Ball Ø                  Größe</p> <p>ØR</p> <p>L</p> <p>Ø</p> <p>&gt; &lt;</p> <p>&lt; &gt;</p>	<p>-Precnik kugle                  Kugel-Durchmesser                  Ball pin diameter</p> <p>-Precnik cevi                  Rohr durchmesser                  Tube diameter</p> <p>-Duzina V-vodjice mosta                  Längenmass von mitte bis mitte                  Distance center to center distance</p> <p>-Precnik otvora                  Bohrungs-durchmesser                  Bore Ø</p> <p>-Debljina flaha                  Breite                  Broad</p> <p>-Rastojanje izmedju otvora                  Lochabstand                  Hole distance</p>
<p><b>Izmenljivi podsklop</b>  <b>Rep.-satz, kugelstük, molekular</b>  <b>Rep.-kit, with pivot pin, molecular</b></p> 	<p>Kugla                  Ball Ø                  Größe</p> <p>Ø</p> <p>&gt; &lt;</p> <p>&lt; &gt;</p>	<p>-Precnik kugle                  Kugel-Durchmesser                  Ball pin diameter</p> <p>-Precnik otvora                  Bohrungs-durchmesser                  Bore Ø</p> <p>-Debljina flaha                  Breite                  Broad</p> <p>-Rastojanje izmedju otvora                  Lochabstand                  Hole distance</p>

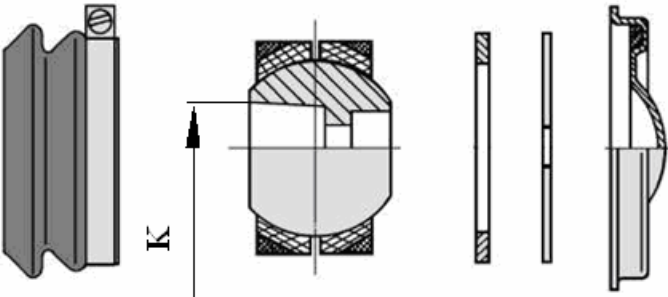
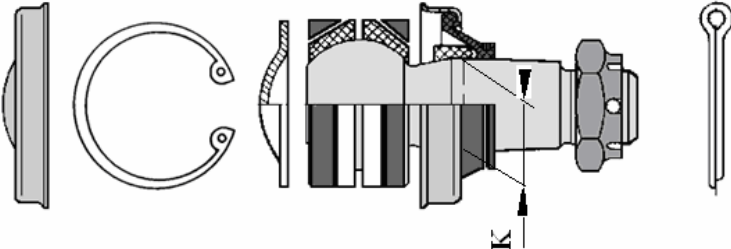
**UPUTSTVO**  
**ERKLÄRUNG**  
**EXPLANATION**

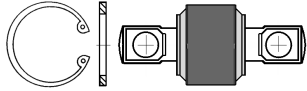
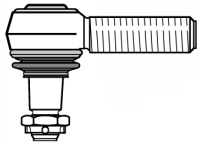
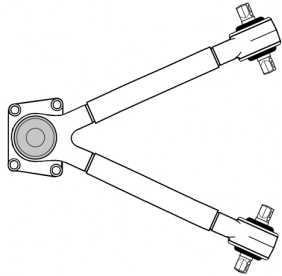
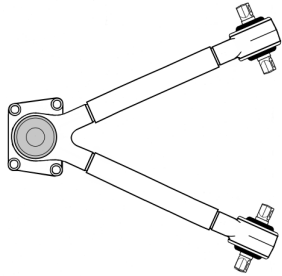
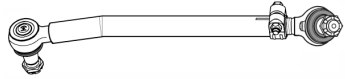
Skica Benennung Description	Simbol Symbole Symbols	Objasnjenje Erklärung Explanation
<p><b>Izmenljivi podsklop</b>  <b>Rep.-satz, kugelhülse</b>  <b>Rep.-kit, with ball housing</b></p> 	<p>Kugla            Ball Ø            Größe</p> <p>K</p>	<p>-Prečnik kugle            Kugel-Durchmesser            Ball pin diameter</p> <p>-Max. prečnik konusnog otvora            Größtmass am innen-konus            Taper hole Ø</p>
<p><b>Izmenljivi podsklop</b>  <b>Rep.-satz, kugelzapfen</b>  <b>Rep.-kit, with ball pin</b></p> 	<p>Kugla            Ball Ø            Größe</p> <p>K</p>	<p>-Prečnik kugle            Kugel-Durchmesser            Ball pin diameter</p> <p>- Max. prečnik konusa            Größtmass am konus            Taper Ø max. size</p>

Originalni broj Cross-Ref.-No. Original Nr.	Br. FAD No. Nr.	Naziv Designation Bezeichnung	Kugla Ball Ø Größe	Konus Taper Konus	Dužina Length Länge	Skica Figure Bild
<b>0 067 354</b>	<b>5117.96.00</b>	Izmenjivi podsklop Repair kit Reparatur satz	62	Ø19 >24<	<130>	
<b>0 069 867</b> 0 161 376 0 608 000 1 142 173	<b>5742.20.00</b>	Zglob, RH M30x1,5 Ball joint, RH Kugelgelenk, RH	40	K26	120	
<b>0 080 521</b>	<b>3873.00.00</b>	V Vođica mosta Triangular torque rod Dreieckslenker  Izmenjivi delovi Parts list Stuckliste 3873.96.00 3875.90.00	65/70	Ø23 >24< <152> K38	608  RØ50	
<b>0 080 521</b> <b>1 368 270</b> 1 390 932 1 617 096	<b>6770.00.00</b>	V Vođica mosta Triangular torque rod Dreieckslenker  Izmenjivi delovi Parts list Stuckliste 6770.90.00 6771.96.00	65/62	Ø23 >24< <152> K38	608  RØ50	
<b>0 094 016</b> 0 171 215	<b>5394.00.00</b>	Spona upravljača Drag link Lenkstange  Izmenjivi delovi Parts list Stuckliste 5810.20.00	50/40	K30	725  RØ40	
<b>0 094 029</b> 0 117 343 94 029	<b>5393.00.00</b>	Spona upravljača Drag link Lenkstange  Izmenjivi delovi Parts list Stuckliste 5810.20.00	50/40	K30	860  RØ40	



Originalni broj Cross-Ref.-No. Original Nr.	Br. FAD No. Nr.	Naziv Designation Bezeichnung	Kugla Ball Ø Größe	Konus Taper Konus	Dužina Length Länge	Skica Figure Bild
<b>0 094 038</b> 0 525 433	<b>5392.00.00</b>	Spona upravljača Drag link Lenkstange  Izmenjivi delovi Parts list Stuckliste 5810.20.00	50/40	K30	1005  RØ52	
<b>0 094 044</b> 0 274 878 1 152 427	<b>3889.00.00</b>	Spona upravljača Drag link Lenkstange  Izmenjivi delovi Parts list Stuckliste 5743.20.00	40	K30	1130  RØ40	
<b>0 099 990</b> 099 990	<b>5385.00.00</b>	Vodica mosta Torque rod Achsstrebe  Izmenjivi delovi Parts list Stuckliste 5323.96.00	62	Ø17 >24< <115>	665  RØ50	
<b>0 110 197</b> 0 607 451 0 607 453 1 228 114	<b>5746.20.00</b>	Zglob, RH M28x1,5 Ball joint, RH Kugelgelenk, RH	30	K22	105	
<b>0 267 743</b> 1 361 650 1 656 428	<b>5398.00.00</b>	Vodica mosta Torque rod Achsstrebe  Izmenjivi delovi Parts list Stuckliste 5594.96.00	70	Ø21 >30< <130>	605  RØ50	
<b>0 273 203</b> 1 399 724	<b>3142.20.00</b>	Zglob, RH M22x1,5 * Ball joint, RH Kugelgelenk, RH	40	30	95	

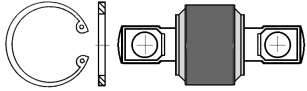
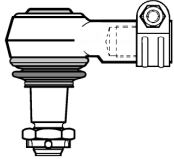
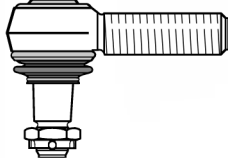
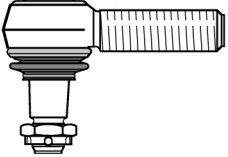
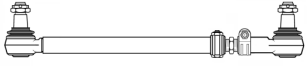
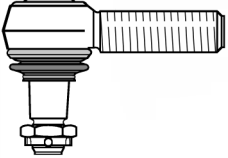
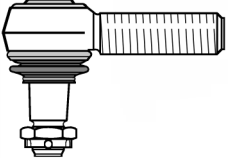

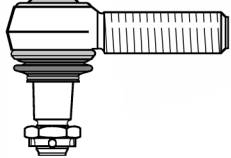
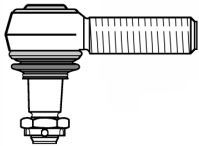
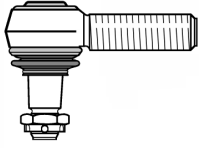
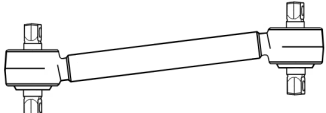
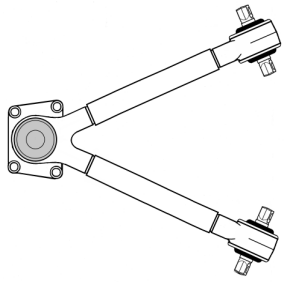
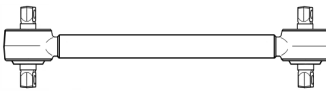

Originalni broj Cross-Ref.-No. Original Nr.	Br. FAD No. Nr.	Naziv Designation Bezeichnung	Kugla Ball Ø Größe	Konus Taper Konus	Dužina Length Länge	Skica Figure Bild
<b>0 513 757</b> 0 691 709	<b>5594.96.00</b>	Izmenjivi podsklop Repair kit Reparatur satz	70	Ø21 >30<	<130>	
<b>0 516 089</b>	<b>3965.20.00</b>	Zglob, RH M18x1,5 * Ball joint, RH Kugelgelenk, RH	30	K22	70	
<b>0 586 714</b> 0 696 226 0 607 073 0 609 634 0 609 643	<b>5810.20.00</b>	Zglob, RH M30x1,5 Ball joint, RH Kugelgelenk, RH	50	K30	135	
<b>0 586 753</b> 0 607 999 0 694 298 0 694 360 0 698 609 1 229 944 1 331 925	<b>5741.20.00</b>	Zglob, RH M30x1,5 Ball joint, RH Kugelgelenk, RH	35	K26	115	
<b>0 589 943</b>	<b>6795.00.00</b>	Spona upravljača Drag link Lenkstange  Izmenjivi delovi Parts list Stuckliste 6795.20.00	35	K26	1058 RØ36	
<b>0 607 053</b> 0 696 225 1 228 115	<b>5743.10.00</b>	Zglob, LH M30x1,5 Ball joint, LH Kugelgelenk, LH	40	K30	120	
<b>0 607 452</b>	<b>5746.10.00</b>	Zglob, LH M28x1,5 Ball joint, LH Kugelgelenk, LH	30	K22	105	

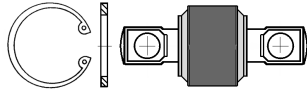
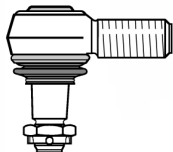
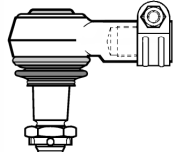
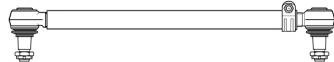
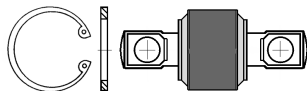
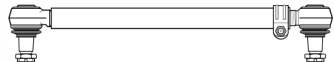
Originalni broj Cross-Ref.-No. Original Nr.	Br. FAD No. Nr.	Naziv Designation Bezeichnung	Kugla Ball Ø Größe	Konus Taper Konus	Dužina Length Länge	Skica Figure Bild
<b>0 607 981</b> 0 698 450 1 257 890 1 603 789	<b>5743.20.00</b>	Zglob, RH M30x1,5 Ball joint, RH Kugelgelenk, RH	40	K30	120	
<b>0 607 998</b> 1 319 838	<b>5741.10.00</b>	Zglob, LH M30x1,5 Ball joint, LH Kugelgelenk, LH	35	K26	115	
<b>0 608 530</b>	<b>5805.20.00</b>	Zglob, RH M24x1,5 Ball joint, RH Kugelgelenk, RH	30	K20	95	
<b>0 646 373</b> 0 655 695 0 655 697 1 284 860 1 620 438	<b>5399.00.00</b>	Vodica mosta Torque rod Achsstrebe  Izmenjivi delovi Parts list Stuckliste 5594.96.00	70	Ø21 >30< <130>	600  RØ50	
<b>0 649 819</b> 1 620 437 1 793 877	<b>3876.00.00</b>	V Vodica mosta Triangular torque rod Dreieckslenker  Izmenjivi delovi Parts list Stuckliste 5587.96.00 5943.90.00	80	Ø23 >35< <152>	604  RØ58	
<b>0 658 104</b>	<b>6772.00.00</b>	Vodica mosta Torque rod Achsstrebe  Izmenjivi delovi Parts list Stuckliste 5170.96.00	70	Ø19 >30< <130>	600  RØ50	

Originalni broj Cross-Ref.-No. Original Nr.	Br. FAD No. Nr.	Naziv Designation Bezeichnung	Kugla Ball Ø Größe	Konus Taper Konus	Dužina Length Länge	Skica Figure Bild
<b>0 661 406</b> 0 661 407	<b>5386.00.00</b>	Vodica mosta Torque rod Achsstrebe  Izmenjivi delovi Parts list Stuckliste 5386.96.00	78.5	Ø21 >35< <130>	600  RØ58	
<b>0 689 747</b>	<b>5847.96.00</b>	Izmenjivi podsklop Repair kit Reparatur satz	70	K45		
<b>0 689 748</b>	<b>5323.96.00</b>	Izmenjivi podsklop Repair kit Reparatur satz	62	Ø17 >24<	<115>	
<b>0 689 749</b>	<b>5170.96.00</b>	Izmenjivi podsklop Repair kit Reparatur satz	70	Ø19 >30<	<130>	
<b>0 691 703</b>	<b>3744.96.00</b>	Izmenjivi podsklop Repair kit Reparatur satz	70	Ø21 >24<	<152>	
<b>0 691 704</b>	<b>5121.90.00</b>	Izmenjivi podsklop Repair kit Reparatur satz	65	K38		
<b>0 693 778</b>	<b>3755.90.00</b>	Izmenjivi podsklop Repair kit Reparatur satz	65	Ø21 >24<	<152>	
<b>0 696 600</b>	<b>3875.90.00</b>	Izmenjivi podsklop Repair kit Reparatur satz	65	K38		

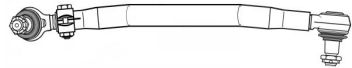
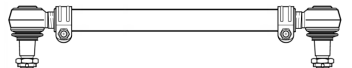
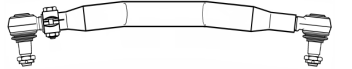

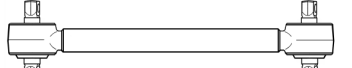
Originalni broj Cross-Ref.-No. Original Nr.	Br. FAD No. No. Nr.	Naziv Designation Bezeichnung	Kugla Ball Ø Größe	Konus Taper Konus	Dužina Length Länge	Skica Figure Bild
<b>0 698 724</b>	<b>3873.96.00</b>	Izmenjivi podsklop Repair kit Reparatur satz	70	Ø23 >24<	<152>	
<b>0 817 823</b>	<b>6297.20.00</b>	Zglob, RHM24x1,5 Ball joint, RH Kugelgelenk, RH	40	K30	75	
<b>0 817 824</b>	<b>7474.20.00</b>	Zglob, RHM24x1,5 * Ball joint, RH Kugelgelenk, RH	40	K30	95	
<b>1 143 324</b> 1 191 900	<b>6781.00.00</b>	Spona upravljača Drag link Lenkstange  Izmenjivi delovi Parts list Stuckliste 5741.20.00	35	K26	1190 RØ40	
<b>1 243 618</b>	<b>6409.96.00</b>	Izmenjivi podsklop Repair kit Reparatur satz	55	Ø17 >24<	<115>	
<b>1 257 991</b> 1 351 718 1 385 493	<b>6782.00.00</b>	Spona upravljača Drag link Lenkstange  Izmenjivi delovi Parts list Stuckliste 5741.20.00	35	K26	860 RØ36	



Originalni broj Cross-Ref.-No. Original Nr.	Br. FAD No. Nr.	Naziv Designation Bezeichnung	Kugla Ball Ø Größe	Konus Taper Konus	Dužina Length Länge	Skica Figure Bild
<b>1 257 992</b> 1 351 732 1 385 490	<b>6773.00.00</b>	Spona upravljača Drag link Lenkstange  Izmenjivi delovi Parts list Stuckliste 5741.20.00 5741.10.00	35	K26	831  RØ36	
<b>1 261 101</b>	<b>5387.00.00</b>	Vođica mosta Torque rod Achsstrebe  Izmenjivi delovi Parts list Stuckliste 3755.90.00 5959.90.00	65	Ø19 Ø21  >30< >24<  <130> <152>	390  RØ50	
<b>1 270 854</b> 1 337 644	<b>6817.00.00</b>	Spona upravljača Drag link Lenkstange  Izmenjivi delovi Parts list Stuckliste 5741.20.00 5741.10.00	35	K26	1734  RØ40	
<b>1 271 124</b>	<b>5959.90.00</b>	Izmenjivi podsklop Repair kit Reparatur satz	65	Ø19 >30<	<130>	
<b>1 271 125</b>	<b>4163.20.00</b>	Zglob, RH M30x1,5 * Ball joint, RH Kugelgelenk, RH	50	K38	86	
<b>1 283 211</b> 1 351 714 1 385 497	<b>6784.00.00</b>	Spona upravljača Drag link Lenkstange  Izmenjivi delovi Parts list Stuckliste 5741.20.00	35	K26	876  RØ52	

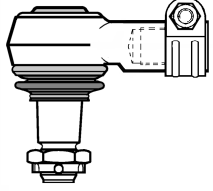
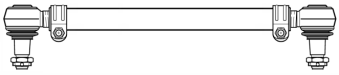
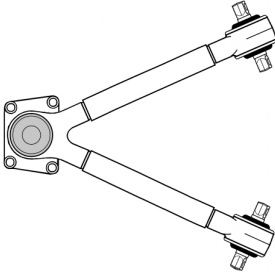

Originalni broj Cross-Ref.-No. Original Nr.	Br. FAD No. No. Nr.	Naziv Designation Bezeichnung	Kugla Ball Ø Größe	Konus Taper Konus	Dužina Length Länge	Skica Figure Bild
1 283 212 1 351 715 1 385 492	5389.00.00	Spona upravljača Drag link Lenkstange  Izmenjivi delovi Parts list Stuckliste 5741.20.00	35	K26	848  RØ52	
1 290 321 1 353 394	6780.00.00	Poprečna spona Tie rod Spurstange Izmenjivi delovi Parts list Stuckliste 5741.10.00 5741.20.00	35	K26	1752  RØ40	
1 291 048 1 351 735 1 385 500	6793.00.00	Spona upravljača Drag link Lenkstange Izmenjivi delovi Parts list Stuckliste 5741.20.00	35	K26	1008  RØ62	
1 291 060 1 351 734 1 385 499	3879.00.00	Spona upravljača Drag link Lenkstange Izmenjivi delovi Parts list Stuckliste 5741.20.00	35	K26	1005  RØ52	
1 294 251	6816.00.00	Vođica mosta Track control arm Achsstrebe  Izmenjivi delovi Parts list Stuckliste 5128.96.00	55	Ø19 >24< <130>	606  RØ40	
1 297 572 1 361 155	6786.00.00	Poprečna spona Tie rod Spurstange Izmenjivi delovi Parts list Stuckliste 6791.20.00	35	K26	1522  RØ52	

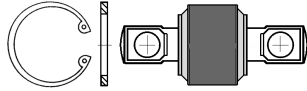

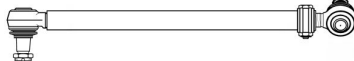
Originalni broj Cross-Ref.-No. Original Nr.	Br. FAD No. Nr.	Naziv Designation Bezeichnung	Kugla Ball Ø Größe	Konus Taper Konus	Dužina Length Länge	Skica Figure Bild
<b>1 306 333</b> 1 351 741 1 385 487	<b>6794.00.00</b>	Spona upravljača Drag link Lenkstange  Izmenjivi delovi Parts list Stuckliste 5741.20.00	35	K26	588  RØ40	
<b>1 311 048</b> 1 351 737 1 385 498	<b>6815.00.00</b>	Spona upravljača Drag link Lenkstange  Izmenjivi delovi Parts list Stuckliste 5741.20.00	35	K26	998  RØ40	
<b>1 315 530</b> 1 351 731 1 385 506	<b>6783.00.00</b>	Spona upravljača Drag link Lenkstange	35	K26	1658  RØ52	
<b>1 320 855</b> 1 342 026	<b>3903.20.00</b>	Zglob, RH M30x1,5 Ball joint, RH Kugelgelenk, RH	35	K26	141	
<b>1 321170</b> 1 351 743 1 385 494	<b>6987.00.00</b>	Spona upravljača Drag link Lenkstange  Izmenjivi delovi Parts list Stuckliste 3903.20.00 5741.10.00	35	K26	860  RØ36	
<b>1 321 936</b>	<b>5128.96.00</b>	Izmenjivi podsklop Repair kit Reparatur satz	55	Ø19 >24<	<130>	

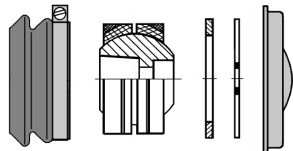
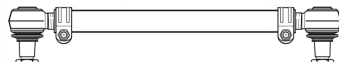
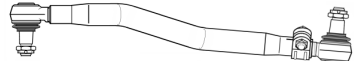

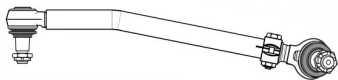
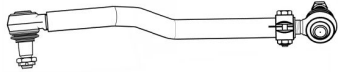
Originalni broj Cross-Ref.-No. Original Nr.	Br. FAD No. Nr.	Naziv Designation Bezeichnung	Kugla Ball Ø Größe	Konus Taper Konus	Dužina Length Länge	Skica Figure Bild
<b>1 344 684</b>	<b>6795.20.00</b>	Zglob, RHM24x1,5 * Ball joint, RH Kugelgelenk, RH	35	K26	115	
<b>1 351 205</b> 1 353 395	<b>6825.00.00</b>	Poprečna spona Tie rod Spurstange  Izmenjivi delovi Parts list Stuckliste 5741.10.00 5741.20.00	35	K26	1646  RØ40	
<b>1 361 652</b> 1 620 436 1 793 876	<b>3877.00.00</b>	V Vođica mosta Triangular torque rod Dreieckslenker  Izmenjivi delovi Parts list Stuckliste 5943.90.00 3873.96.00	80/70	Ø23 >24< <152> K46	608  RØ50	
<b>1 363 858</b> 1 448 062	<b>6787.00.00</b>	Spona upravljača Drag link Lenkstange  Izmenjivi delovi Parts list Stuckliste 5743.20.00	40	K30	855  RØ52	
<b>1 363 859</b> 1 448 063 1 602 821	<b>6814.00.00</b>	Spona upravljača Drag link Lenkstange  Izmenjivi delovi Parts list Stuckliste 5743.20.00	40	K30	865  RØ50	
<b>1 376 729</b>	<b>6771.96.00</b>	Izmenjivi podsklop Repair kit Reparatur satz	62	Ø23 >24<	<152>	

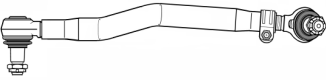
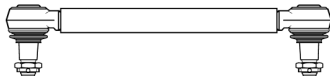
Originalni broj Cross-Ref.-No. Original Nr.	Br. FAD No. Nr.	Naziv Designation Bezeichnung	Kugla Ball Ø Größe	Konus Taper Konus	Dužina Length Länge	Skica Figure Bild
1 380 417 1 451 129	6821.00.00	Spona upravljača Drag link Lenkstange  Izmenjivi delovi Parts list Stuckliste 5743.20.00	40	K30	860  RØ36	
1 395 993	6986.00.00	Spona upravljača Drag link Lenkstange Izmenjivi delovi Parts list Stuckliste 4563.20.00	40	K30	996  RØ40	
1 395 994	6796.00.00	Spona upravljača Drag link Lenkstange Izmenjivi delovi Parts list Stuckliste 5743.20.00	40	K30	991  RØ50	
1 398 368	6770.90.00	Izmenjivi podsklop Repair kit Reparatur satz	65	K38		
1 400 156 1 405 823 1 407 963	4471.00.00	Poprečna spona Tie rod Spurstange Izmenjivi delovi Parts list Stuckliste 5741.10.00 5741.20.00	35	K26	1640  RØ40	
1 405 309	6981.00.00	Spona upravljača Drag link Lenkstange  Izmenjivi delovi Parts list Stuckliste 6321.10.00	40	K30	926  RØ50	

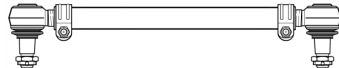
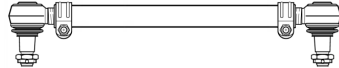
Originalni broj Cross-Ref.-No. Original Nr.	Br. FAD No. Nr.	Naziv Designation Bezeichnung	Kugla Ball Ø Größe	Konus Taper Konus	Dužina Length Länge	Skica Figure Bild
<b>1 405 363</b>	<b>6826.00.00</b>	Spona upravljača Drag link Lenkstange  Izmenjivi delovi Parts list Stuckliste 5741.20.00	35	K26	909  RØ42	
<b>1 405 655</b> 1 406 025 1 407 144 1 700 912	<b>6812.00.00</b>	Spona upravljača Drag link Lenkstange  Izmenjivi delovi Parts list Stuckliste 5746.10.00	30	22	880  RØ36	
<b>1 406 038</b> 1 700 914	<b>6823.00.00</b>	Spona upravljača Drag link Lenkstange Izmenjivi delovi Parts list Stuckliste 6823.10.00	30	K22	895,5  RØ40	
<b>1 408 040</b> 1 353 395	<b>6827.00.00</b>	Poprečna spona Tie rod Spurstange  Izmenjivi delovi Parts list Stuckliste 6832.20.00	40	K30	1680  RØ50	
<b>1 426 101</b>	<b>6829.00.00</b>	Spona upravljača Drag link Lenkstange  Izmenjivi delovi Parts list Stuckliste 4563.20.00	40	K30	1004  RØ52	
<b>1 426 375</b> 1 451 126	<b>6985.00.00</b>	Spona upravljača Drag link Lenkstange	40	K30	1054  RØ36	

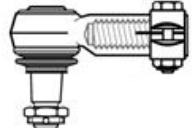
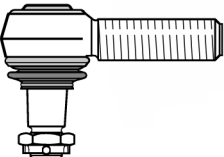
Originalni broj Cross-Ref.-No. Original Nr.	Br. FAD No. Nr.	Naziv Designation Bezeichnung	Kugla Ball Ø Größe	Konus Taper Konus	Dužina Length Länge	Skica Figure Bild
<b>1 451 118</b>	<b>6982.00.00</b>	Spona upravljača Drag link Lenkstange  Izmenjivi delovi Parts list Stuckliste 4126.20.00 5743.10.00	40	K30	860  RØ40	
<b>1 451 119</b>	<b>6983.00.00</b>	Spona upravljača Drag link Lenkstange  Izmenjivi delovi Parts list Stuckliste 5743.10.00 5743.20.00	40	K30	590  RØ40	
<b>1 451 122</b>	<b>6828.00.00</b>	Spona upravljača Drag link Lenkstange	40	K30	1971  RØ52	
<b>1 602 820</b>	<b>6820.00.00</b>	Spona upravljača Drag link Lenkstange  Izmenjivi delovi Parts list Stuckliste 5743.20.00	40	K30	855  RØ50	
<b>1 603 788</b> 1 604 105	<b>6789.20.00</b>	Zglob, RH M24x1,5 * Ball joint, RH Kugelgelenk, RH	40	K30	120	
<b>1 604 247</b>	<b>6811.10.00</b>	Zglob, LH M28x1,5 Ball joint, LH Kugelgelenk, LH	35	K26	148	

Originalni broj Cross-Ref.-No. Original Nr.	Br. FAD No. Nr.	Naziv Designation Bezeichnung	Kugla Ball Ø Größe	Konus Taper Konus	Dužina Length Länge	Skica Figure Bild
<b>1 604 248</b>	<b>6811.20.00</b>	Zglob, LH M28x1,5 Ball joint, RH Kugelgelenk, RH	35	K26	148	
<b>1 700 000</b>	<b>6798.00.00</b>	Poprečna spona Tie rod Spurstange Izmenjivi delovi Parts list Stuckliste 5743.10.00 5743.20.00	40	K30	1690 RØ40	
<b>1 700 001</b> 1 353 395	<b>6824.00.00</b>	Poprečna spona Tie rod Spurstange  Izmenjivi delovi Parts list Stuckliste 5743.10.00 5743.20.00	40	K30	1743 RØ40	
<b>1 732 972</b>	<b>6980.00.00</b>	Poprečna spona Tie rod Spurstange  Izmenjivi delovi Parts list Stuckliste 5743.10.00 5743.20.00	40	K30	1643 RØ40	
<b>3 093 647</b>	<b>4233.20.00</b>	Zglob, RH M30x1,5 Ball joint, RH Kugelgelenk, RH	40	K28,6	141	
<b>696 321</b>	<b>5587.96.00</b>	Izmenjivi podsklop Repair kit Reparatur satz	78.5	Ø23 >35<	<152>	

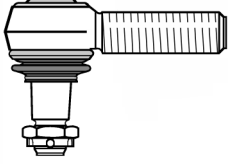
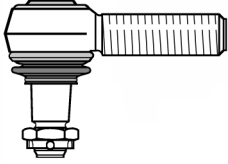
Originalni broj Cross-Ref.-No. Original Nr.	Br. FAD No. Nr.	Naziv Designation Bezeichnung	Kugla Ball Ø Größe	Konus Taper Konus	Dužina Length Länge	Skica Figure Bild
<b>ACU 9239</b>	<b>6790.10.00</b>	Zglob, LH M28x1,5 Ball joint, LH Kugelgelenk, LH	35	K22	180	
<b>ACU 9240</b>	<b>6790.20.00</b>	Zglob, RH M28x1,5 Ball joint, RH Kugelgelenk, RH	35	K22	180	

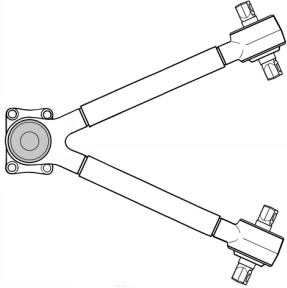
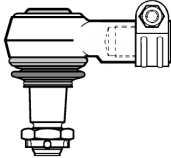
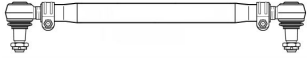
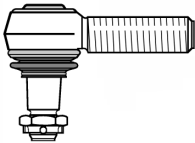
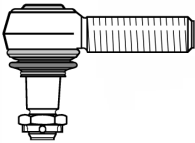

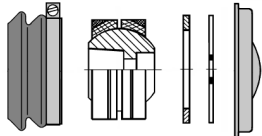
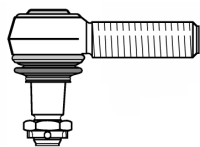
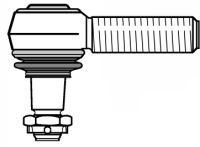
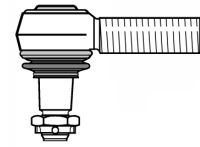
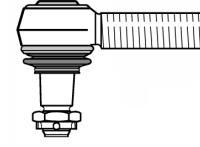
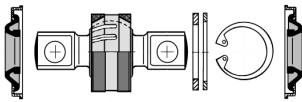
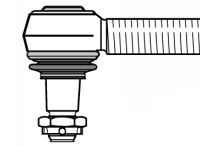
Originalni broj Cross-Ref.-No. Original Nr.	Br. FAD No. No. Nr.	Naziv Designation Bezeichnung	Kugla Ball Ø Größe	Konus Taper Konus	Dužina Length Länge	Skica Figure Bild
<b>0813 7026</b> 4100 2770 4100 9665 4102 8598 4102 8600 4103 4479 4104 2050	<b>5120.00.00</b>	V Vođica mosta Triangular torque rod Dreieckslenker  Izmenjivi delovi Parts list Stuckliste 5861.96.00 5120.90.00	65/62	Ø21 >24< <130> K38	665  RØ50	
<b>0928 1792</b> 928 1792	<b>7474.20.00</b>	Zglob, RH 24x1.5 * Ball joint, RH Kugelgelenk, RH	40	K30	95	
<b>247 5843</b> 4201 4656 4202 6837 4202 6840 4203 7655 4203 7657	<b>6364.00.00</b>	Poprečna spona Tie rod Spurstange  Izmenjivi delovi Parts list Stuckliste 5743.10.00 5743.20.00	40	K30	1606  RØ50	
<b>296 6252</b> 296 9808 4248 3386 4248 8269 4248 9573 4248 9594 4249 1638 480 2443 483 3829 812 2752	<b>5743.20.00</b>	Zglob, RH M30x1.5 Ball joint, RH Kugelgelenk, RH	40	K30	120	
<b>296 6321</b> 296 6635 4248 4886 483 3825 819 3645 855 8533 858 2322	<b>5746.20.00</b>	Zglob, RH M28x1.5 Ball joint, RH Kugelgelenk, RH	30	K22	105	

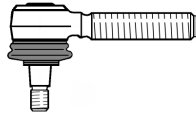
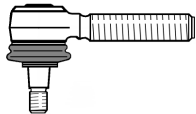
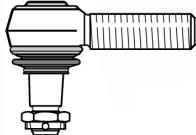
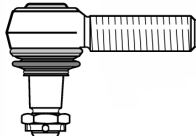
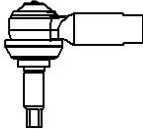
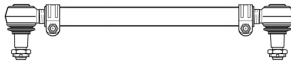
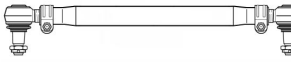

Originalni broj Cross-Ref.-No. Original Nr.	Br. FAD No. Nr.	Naziv Designation Bezeichnung	Kugla Ball Ø Größe	Konus Taper Konus	Dužina Length Länge	Skica Figure Bild
<b>296 8454</b>	<b>5121.90.00</b>	Izmenjivi podsklop Repair kit Reparatur satz	65	K38		
<b>296 9507</b> 4248 4887 483 3826 812 3394 855 8536	<b>5746.10.00</b>	Zglob, LH M28x1.5 Ball joint, LH Kugelgelenk, LH	30	K22	105	
<b>298 0129</b> 298 4511 4249 3782 483 3821 483 3826 483 3828 812 2755	<b>5741.10.00</b>	Zglob, LH M30x1.5 Ball joint, LH Kugelgelenk, LH	35	K26	115	
<b>298 0323</b> 4248 3520 4249 3781	<b>5741.20.00</b>	Zglob, RH M30x1.5 Ball joint, RH Kugelgelenk, RH	35	K26	115	
<b>298 0875</b>	<b>5742.20.00</b>	Zglob, RH M30x1.5 Ball joint, RH Kugelgelenk, RH	40	K26	120	
<b>298 0884</b>	<b>5959.90.00</b>	Izmenjivi podsklop Repair kit Reparatur satz	65	Ø19 >30<	<130>	
<b>298 4061</b> 4248 9395 4249 1957 480 2444 483 3830 819 0225	<b>5743.10.00</b>	Zglob, LH M30x1.5 Ball joint, LH Kugelgelenk, LH	40	K30	120	

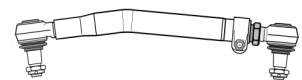
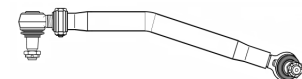
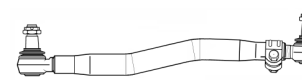
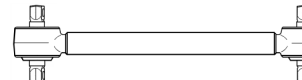

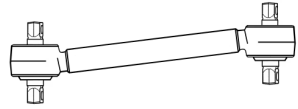
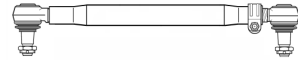
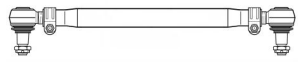
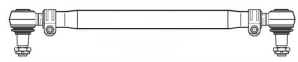

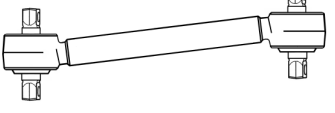
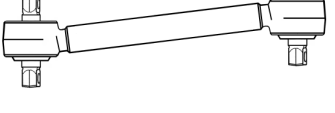

Originalni broj Cross-Ref.-No. Original Nr.	Br. FAD No. Nr.	Naziv Designation Bezeichnung	Kugla Ball Ø Größe	Konus Taper Konus	Dužina Length Länge	Skica Figure Bild
<b>343 5786</b> 798 1909 8602 7074	<b>3590.20.00</b>	Zglob, RH M14x1.5 Ball joint, RH Kugelgelenk, RH	22	K12	85	
<b>343 5788</b> 4204 2912	<b>3567.20.00</b>	Zglob, RH M16x1.5 Ball joint, RH Kugelgelenk, RH	22	K12	90	
<b>401 8036</b> 466 3787	<b>5391.20.00</b>	Zglob, RH M25x1.5 Ball joint, RH Kugelgelenk, RH	30	K22	105	
<b>401 8037</b> 466 3791	<b>5391.10.00</b>	Zglob, LH M25x1.5 Ball joint, LH Kugelgelenk, LH	30	K22	105	
<b>4100 2118</b> 4120 3863 4204 1327 4207 9853	<b>6432.20.00</b>	Zglob, RH M10x1.5 Ball joint, RH Kugelgelenk, RH	10	K10	55	
<b>4100 5309</b> 4100 5460 816 5309	<b>6405.00.00</b>	Poprečna spona Tie rod Spurstange  Izmenjivi delovi Parts list Stuckliste 5743.10.00 5743.20.00	40	K30	1577  RØ42	
<b>4100 5450</b> 4100 5451 4103 6944 4104 2730 816 3773	<b>6439.00.00</b>	Poprečna spona Tie rod Spurstange  Izmenjivi delovi Parts list Stuckliste 5743.10.00 5743.20.00	40	K30	1641  RØ50	

Originalni broj Cross-Ref.-No. Original Nr.	Br. FAD No. Nr.	Naziv Designation Bezeichnung	Kugla Ball Ø Größe	Konus Taper Konus	Dužina Length Länge	Skica Figure Bild
<b>4100 5463</b> 813 1582 813 2397	<b>5119.00.00</b>	Spona upravljača Drag link Lenkstange  Izmenjivi delovi Parts list Stuckliste 5743.20.00	40	K30	950  RØ52	
<b>4100 5466</b> 4101 6964	<b>6398.00.00</b>	Spona upravljača Drag link Lenkstange  Izmenjivi delovi Parts list Stuckliste 5743.20.00	40	K30	698  RØ52	
<b>4100 5469</b> 4101 1476 4101 6960 4101 6961 813 5492	<b>6414.00.00</b>	Spona upravljača Drag link Lenkstange  Izmenjivi delovi Parts list Stuckliste 5743.20.00	40	K30	824  RØ52	
<b>4100 5475</b> 4100 6093	<b>6422.00.00</b>	Spona upravljača Drag link Lenkstange  Izmenjivi delovi Parts list Stuckliste 5743.20.00	40	K30	952  RØ52	
<b>4100 9961</b>	<b>6441.00.00</b>	Vođica mosta Torque rod Achsstrebe  Izmenjivi delovi Parts list Stuckliste 5117.96.00	62	Ø19 >24< <130>	455  RØ50	

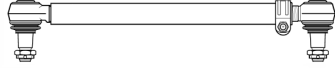
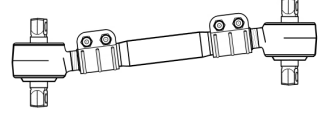
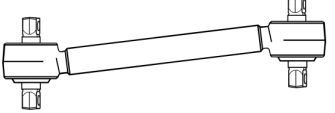
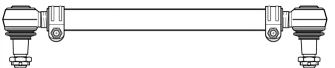
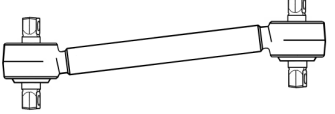
Originalni broj Cross-Ref.-No. Original Nr.	Br. FAD No. No. Nr.	Naziv Designation Bezeichnung	Kugla Ball Ø Größe	Konus Taper Konus	Dužina Length Länge	Skica Figure Bild
<b>4101 1006</b> 4206 5332	<b>5106.00.00</b>	Vođica mosta Torque rod Achsstrebe  Izmenjivi delovi Parts list Stuckliste 5096.96.00	78.5	Ø21 >24< <152>	612  RØ58	
<b>4102 8269</b> 4129 8449	<b>6430.00.00</b>	Spona upravljača Drag link Lenkstange  Izmenjivi delovi Parts list Stuckliste 5743.20.00	40	K30	887  RØ52	
<b>4103 2608</b> 4103 3237	<b>6424.00.00</b>	Poprečna spona Tie rod Spurstange Izmenjivi delovi Parts list Stuckliste 5743.10.00 5743.20.00	40	K30	1477  RØ50	
<b>4103 6943</b>	<b>6418.00.00</b>	Poprečna spona Tie rod Spurstange Izmenjivi delovi Parts list Stuckliste 5743.10.00 5743.20.00	40	K30	1620  RØ50	
<b>4104 2749</b>	<b>6434.00.00</b>	Poprečna spona Tie rod Spurstange Izmenjivi delovi Parts list Stuckliste 5743.20.00	40	K30	1390  RØ58	
<b>4121 4657</b>	<b>6415.00.00</b>	Spona upravljača Drag link Lenkstange  Izmenjivi delovi Parts list Stuckliste 5743.20.00	40	K30	952  RØ52	

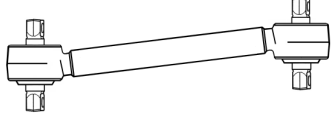
Originalni broj Cross-Ref.-No. Original Nr.	Br. FAD No. No. Nr.	Naziv Designation Bezeichnung	Kugla Ball Ø Größe	Konus Taper Konus	Dužina Length Länge	Skica Figure Bild
<b>4121 5165</b>	<b>6423.00.00</b>	Spona upravljača Drag link Lenkstange  Izmenjivi delovi Parts list Stuckliste 5743.20.00	40	K30	959  RØ52	
<b>4200 0481</b> 4203 4054	<b>5104.00.00</b>	Vodica mosta Torque rod Achsstrebe  Izmenjivi delovi Parts list Stuckliste 5096.96.00	78.5	Ø21 >35< <152>	610  RØ60	
<b>4200 0486</b> 4203 4051	<b>5097.00.00</b>	Vodica mosta Torque rod Achsstrebe  Izmenjivi delovi Parts list Stuckliste 5096.96.00	78.5	Ø21 >35< <152>	630  RØ60	
<b>4200 1325</b> 4200 1326 4208 6458	<b>5118.00.00</b>	Spona upravljača Drag link Lenkstange  Izmenjivi delovi Parts list Stuckliste 5743.20.00	40	K30	880  RØ42	
<b>4200 3432</b>	<b>6403.00.00</b>	Poprečna spona Tie rod Spurstange  Izmenjivi delovi Parts list Stuckliste 5743.10.00 5743.20.00	40	K30	1640  RØ50	

Originalni broj Cross-Ref.-No. Original Nr.	Br. FAD No. Nr.	Naziv Designation Bezeichnung	Kugla Ball Ø Größe	Konus Taper Konus	Dužina Length Länge	Skica Figure Bild
<b>4201 9062</b>	<b>5108.00.00</b>	Spona upravljača Drag link Lenkstange  Izmenjivi delovi Parts list Stuckliste 5743.20.00	40	K30	894  RØ40	
<b>4203 2936</b>	<b>5094.00.00</b>	Vodica mosta Torque rod Achsstrebe  Izmenjivi delovi Parts list Stuckliste 5170.96.00	70	Ø19 >30< <130>	635  RØ50	
<b>4203 2938</b>	<b>5095.00.00</b>	Vodica mosta Torque rod Achsstrebe  Izmenjivi delovi Parts list Stuckliste 5170.96.00	70	Ø19 >30< <130>	617  RØ50	
<b>4203 7386</b> 8601 2923	<b>6359.00.00</b>	Poprečna spona Tie rod Spurstange  Izmenjivi delovi Parts list Stuckliste 5746.10.00 5746.20.00	30	K22	1404  RØ36	
<b>4204 1107</b>	<b>5105.00.00</b>	Vodica mosta Torque rod Achsstrebe  Izmenjivi delovi Parts list Stuckliste 3744.96.00	70	Ø21 >24< <152>	610  RØ50	

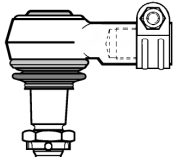
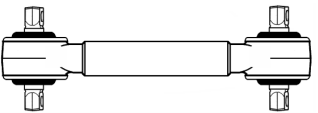



Originalni broj Cross-Ref.-No. Original Nr.	Br. FAD No. No. Nr.	Naziv Designation Bezeichnung	Kugla Ball Ø Größe	Konus Taper Konus	Dužina Length Länge	Skica Figure Bild
<b>4204 2431</b>	<b>5096.00.00</b>	Vodica mosta Torque rod Achsstrebe  Izmenjivi delovi Parts list Stuckliste 5096.96.00	78.5	Ø21 >35< <152>	600  RØ60	
<b>4204 2950</b> 4204 3912	<b>5144.00.00</b>	Spona upravljača Drag link Lenkstange  Izmenjivi delovi Parts list Stuckliste 5743.20.00	40	K30	905 RØ42	
<b>4205 5474</b>	<b>5107.00.00</b>	Spona upravljača Drag link Lenkstange  Izmenjivi delovi Parts list Stuckliste 5743.20.00	40	K30	850 RØ40	
<b>4208 7842</b> 474 7960 474 7961	<b>5113.00.00</b>	Spona upravljača Drag link Lenkstange Izmenjivi delovi Parts list Stuckliste 5743.20.00	40	K30	980 RØ50	
<b>4210 5474</b> 4253 2294	<b>6107.20.00</b>	Zglob, RH26x1.5 * Ball joint, RH Kugelgelenk, RH	50	K38	85	
<b>4212 5057</b> 471 4134 9848 8010	<b>5081.00.00</b>	Vodica mosta Torque rod Achsstrebe  Izmenjivi delovi Parts list Stuckliste 3698.90.00	65	Ø19 >30< <130>	580 RØ50	

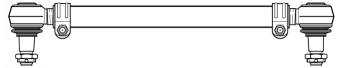

Originalni broj Cross-Ref.-No. Original Nr.	Br. FAD No. No. Nr.	Naziv Designation Bezeichnung	Kugla Ball Ø Größe	Konus Taper Konus	Dužina Length Länge	Skica Figure Bild
<b>4212 5057</b> 471 4134 9848 8010	<b>5114.00.00</b>	Vođica mosta Torque rod Achsstrebe  Izmenjivi delovi Parts list Stuckliste 5959.90.00	65	Ø19 >30< <130>	580  RØ50	
<b>4220 0700</b> 4220 4475 4221 1146 4221 1148	<b>3537.00.00</b>	Spona upravljača Drag link Lenkstange  Izmenjivi delovi Parts list Stuckliste 5746.20.00	30	K22	865 RØ36	
<b>4248 0023</b> 4253 2543 819 3649	<b>5805.10.00</b>	Zglob, LH M24x1.5 Ball joint, LH Kugelgelenk, LH	30	K20	95	
<b>4248 0024</b> 4249 1937	<b>5805.20.00</b>	Zglob, RH M24x1.5 Ball joint, RH Kugelgelenk, RH	30	K20	95	
<b>4248 8722</b>	<b>5170.96.00</b>	Izmenjivi podsklop Repair kit Reparatur satz	70	Ø19 >30<	<130>	
<b>4249 3431</b> 9319 2619	<b>3765.96.00</b>	Izmenjivi podsklop Repair kit Reparatur satz	78.5	Ø21 >24<	<152>	
<b>4253 0316</b> 4253 8047 9315 7156	<b>4163.20.00</b>	Zglob, RH M30x1,5 * Ball joint, RH Kugelgelenk, RH	50	K38	86	

Originalni broj Cross-Ref.-No. Original Nr.	Br. FAD No. Nr.	Naziv Designation Bezeichnung	Kugla Ball Ø Größe	Konus Taper Konus	Dužina Length Länge	Skica Figure Bild
<b>4253 3101</b> 4253 3102	<b>6425.20.00</b>	Zglob, RH M26x1.5 * Ball joint, RH Kugelgelenk, RH	40	K30	80	
<b>445 7748</b> 9319 1941	<b>3559.00.00</b>	Vodica mosta Torque rod Achsstrebe  Izmenjivi delovi Parts list Stuckliste 3559.96.00	70	K38	695 RØ50	
<b>445 7748</b> 9319 1941	<b>5111.00.00</b>	Vodica mosta Torque rod Achsstrebe  Izmenjivi delovi Parts list Stuckliste 5109.90.00	65	K38	695 RØ50	
<b>466 3787</b>	<b>3203.20.00</b>	Zglob, RH M25x1.5 Ball joint, RH Kugelgelenk, RH	30	K22	105	
<b>468 8941</b> 716 7757 856 5366 858 2332	<b>5122.20.00</b>	Zglob, RH M28x1.5 Ball joint, RH Kugelgelenk, RH	35	K26	115	
<b>468 8948</b>	<b>5856.20.00</b>	Zglob, RH M38x1.5 Ball joint, RH Kugelgelenk, RH	40	K30	120	
<b>468 8949</b>	5856.10.00	Zglob, LH M38x1.5 Ball joint, LH Kugelgelenk, LH	40	K30	120	

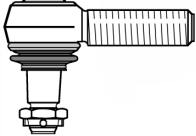
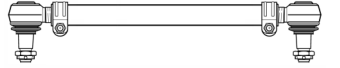

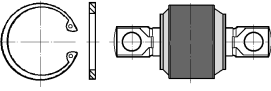
Originalni broj Cross-Ref.-No. Original Nr.	Br. FAD No. No. Nr.	Naziv Designation Bezeichnung	Kugla Ball Ø Größe	Konus Taper Konus	Dužina Length Länge	Skica Figure Bild
471 1108 471 1109	5143.00.00	Spona upravljača Drag link Lenkstange  Izmenjivi delovi Parts list Stuckliste 5856.20.00	40	K30	850 RØ50	
471 6271	5121.00.00	V Vođica mosta Triangulartorque rod Dreieckslenker  Izmenjivi delovi Parts list Stuckliste 5959.90.00 5121.90.00	65/65	Ø19 >30< <130> K38	657/ 688  RØ50	
471 6799	5126.00.00	V Vođica mosta Triangulartorque rod Dreieckslenker  Izmenjivi delovi Parts list Stuckliste 5959.90.00 5121.90.00	65/65	Ø19 >30< <130> K38	657/ 688  RØ50	
471 9609	5116.00.00	Vođica mosta Torque rod Achsstrebe Izmenjivi delovi Parts list Stuckliste 5959.90.00	65	Ø19 >30< <130>	677  RØ50	
474 1171	6399.00.00	Stabilizator Stabilizer link Koppelstang	40	K30	355  RØ40	
477 3359 483 4037	5122.00.00	Spona upravljača Drag link Lenkstange Izmenjivi delovi Parts list Stuckliste 5122.20.00	35	K26	975  RØ36	

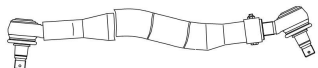
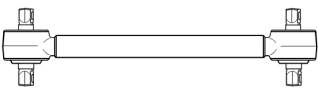

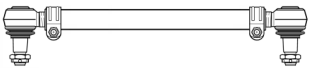
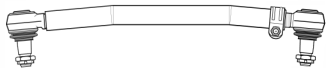
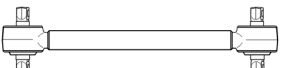
Originalni broj Cross-Ref.-No. Original Nr.	Br. FAD No. No. Nr.	Naziv Designation Bezeichnung	Kugla Ball Ø Größe	Konus Taper Konus	Dužina Length Länge	Skica Figure Bild
<b>485 4871</b>	<b>6404.00.00</b>	Poprečna spona Tie rod Spurstange  Izmenjivi delovi Parts list Stuckliste 5741.10.00 5741.20.00	35	K26	1584  RØ40	
<b>485 4874</b>	<b>5123.00.00</b>	Spona upravljača Drag link Lenkstange  Izmenjivi delovi Parts list Stuckliste 5741.20.00	35	K26	900  RØ42	
<b>486 8942</b> 858 2333	<b>5122.10.00</b>	Zglob, LH M28x1.5 Ball joint, LH Kugelgelenk, LH	35	K26	115	
<b>500 307 556</b> 9840 2553	<b>6402.00.00</b>	Poprečna spona Tie rod Spurstange  Izmenjivi delovi Parts list Stuckliste 5741.10.00 5741.20.00	35	K26	1490  RØ40	
<b>500 324 282</b>	<b>6429.00.00</b>	Spona upravljača Drag link Lenkstange  Izmenjivi delovi Parts list Stuckliste 5741.20.00	35	K26	785  RØ40	
<b>500 333 284</b>	<b>4569.96.00</b>	Izmenjivi podsklop Repair kit Reparatur satz	62	Ø19 >24<	<130>	



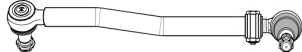
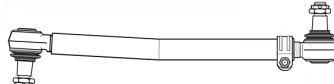
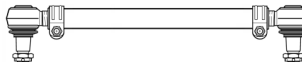
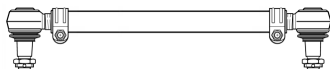
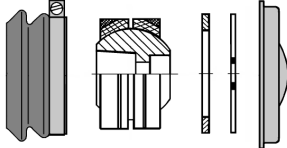
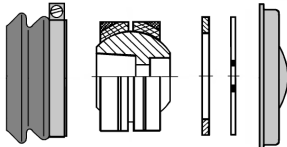

Originalni broj Cross-Ref.-No. Original Nr.	Br. FAD No. No. Nr.	Naziv Designation Bezeichnung	Kugla Ball Ø Größe	Konus Taper Konus	Dužina Length Länge	Skica Figure Bild
<b>500 336 085</b> 9945 5009	<b>6433.00.00</b>	Spona upravljača Drag link Lenkstange Izmenjivi delovi Parts list Stuckliste 4681.20.00	40	K30	883 RØ52	
<b>500 338 783</b>	<b>6442.00.00</b>	Vođica mosta Torque rod Achsstrebe  Izmenjivi delovi Parts list Stuckliste 4569.96.00	62	Ø19 >24< <130>	695 RØ50	
<b>500 397 738</b>	<b>4671.00.00</b>	Spona upravljača Drag link Lenkstange Izmenjivi delovi Parts list Stuckliste 5743.20.00	40	K30	959 RØ52	
<b>504 034 521</b>	<b>6438.00.00</b>	Poprečna spona Tie rod Spurstange Izmenjivi delovi Parts list Stuckliste 5743.10.00 5743.20.00	40	K30	1570 RØ42	
<b>504 049 893</b>	<b>6435.00.00</b>	Spona upravljača Drag link Lenkstange Izmenjivi delovi Parts list Stuckliste 5743.20.00	40	K30	892 RØ42	
<b>813 7027</b>	<b>6440.00.00</b>	Vođica mosta Torque rod Achsstrebe Izmenjivi delovi Parts list Stuckliste 5128.96.00	55	Ø19 >24< <130>	594 RØ50	

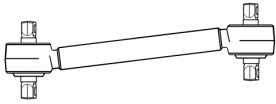
Originalni broj Cross-Ref.-No. Original Nr.	Br. FAD No. Nr.	Naziv Designation Bezeichnung	Kugla Ball Ø Größe	Konus Taper Konus	Dužina Length Länge	Skica Figure Bild
<b>855 8522</b>	<b>5142.00.00</b>	Spona upravljača Drag link Lenkstange  Izmenjivi delovi Parts list Stuckliste 4746.20.00	30	K22	820 RØ30	
<b>855 8527</b> 4248 7165 9319 4626	<b>4746.20.00</b>	Zglob,RH M24x1.5 Ball joint, RH Kugelgelenk, RH	30	K22	105	
<b>855 9559</b> 859 1222	<b>3212.00.00</b>	Spona upravljača Drag link Lenkstange  Izmenjivi delovi Parts list Stuckliste 4746.20.00	30	K22	830 RØ30	
<b>856 4248</b> 859 1219	<b>5147.00.00</b>	Spona upravljača Drag link Lenkstange  Izmenjivi delovi Parts list Stuckliste 4746.20.00	30	K22	761 RØ30	
<b>856 4386</b> 858 2320	<b>3213.00.00</b>	Poprečna spona Tie rod Spurstange Izmenjivi delovi Parts list Stuckliste 5746.10.00 5746.20.00	30	K22	1348 RØ36	
<b>856 5366</b> 858 2330	<b>3393.00.00</b>	Poprečna spona Tie rod Spurstange Izmenjivi delovi Parts list Stuckliste 5122.10.00 5122.20.00	35	K26	1344 RØ36	

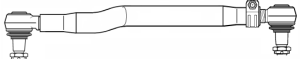
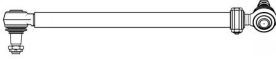
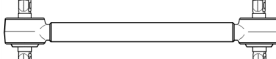
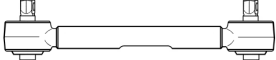
Originalni broj Cross-Ref.-No. Original Nr.	Br. FAD No. Nr.	Naziv Designation Bezeichnung	Kugla Ball Ø Größe	Konus Taper Konus	Dužina Length Länge	Skica Figure Bild
<b>856 7618</b> 858 2350	<b>5145.00.00</b>	Spona upravljača Drag link Lenkstange  Izmenjivi delovi Parts list Stuckliste 5122.20.00	35	K26	755  RØ40	
<b>857 0528</b>	<b>5148.00.00</b>	Spona upravljača Drag link Lenkstange  Izmenjivi delovi Parts list Stuckliste 5741.20.00	35	K26	690  RØ40	
<b>858 7018</b>	<b>5087.00.00</b>	Poprečna spona Tie rod Spurstange  Izmenjivi delovi Parts list Stuckliste 5122.10.00 5122.20.00	35	K26	1316  RØ36	
<b>8601 1651</b>	<b>6363.00.00</b>	Poprečna spona Tie rod Spurstange  Izmenjivi delovi Parts list Stuckliste 5741.10.00 5741.20.00	35	K26	1506  RØ40	
<b>9316 1631</b> 9316 1638	<b>5120.90.00</b>	Izmenjivi podsklop Repair kit Reparatur satz	65	K38		
<b>9316 1958</b>	<b>6436.90.00</b>	Izmenjivi podsklop Repair kit Reparatur satz	65	K38		

Originalni broj Cross-Ref.-No. Original Nr.	Br. FAD No. Nr.	Naziv Designation Bezeichnung	Kugla Ball Ø Größe	Konus Taper Konus	Dužina Length Länge	Skica Figure Bild
<b>9316 1959</b>	<b>5120.45.00</b>	Izmenjivi podsklop Repair kit Reparatur satz	65	K38 <144>		
<b>9316 3617</b>	<b>5128.96.00</b>	Izmenjivi podsklop Repair kit Reparatur satz	55	Ø19 >24<	<130>	
<b>9319 2361</b>	<b>5117.96.00</b>	Izmenjivi podsklop Repair kit Reparatur satz	62	Ø19 >24<	<130>	
<b>9319 2618</b>	<b>3744.96.00</b>	Izmenjivi podsklop Repair kit Reparatur satz	70	Ø21 >24<	<152>	
<b>9319 2809</b>	<b>6426.20.00</b>	Zglob, RH M30x1.5* Ball joint, RH Kugelgelenk, RH	40	K30	80	
<b>9380 0662</b> 9380 4059	<b>1480.20.00</b>	Zglob, RH M16x1.5* Ball joint, RH Kugelgelenk, RH	25	K18	80	
<b>9380 0662</b> 9380 4059	<b>3228.20.00</b>	Zglob, RH M16x1.5* Ball joint, RH Kugelgelenk, RH	25	K18	80	
<b>9380 2209</b> 9380 4060	<b>1481.20.00</b>	Zglob, RH M20x1.5* Ball joint, RH Kugelgelenk, RH	35	K24	72	

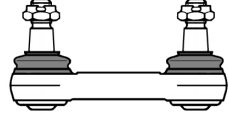
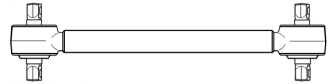

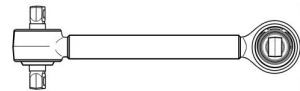
Originalni broj Cross-Ref.-No. Original Nr.	Br. FAD No. No. Nr.	Naziv Designation Bezeichnung	Kugla Ball Ø Größe	Konus Taper Konus	Dužina Length Länge	Skica Figure Bild
<b>9710 4299</b>	<b>6341.00.00</b>	Vodica mosta Torque rod Achsstrebe  Izmenjivi delovi Parts list Stuckliste 5117.96.00	62	Ø19 >24< <130>	803  RØ46	
<b>9840 2544</b> 9846 7459	<b>5124.00.00</b>	Spona upravljača Drag link Lenkstange  Izmenjivi delovi Parts list Stuckliste 5741.20.00	35	K26	820  RØ40	
<b>9844 6354</b>	<b>5146.00.00</b>	Spona upravljača Drag link Lenkstange  Izmenjivi delovi Parts list Stuckliste 5743.20.00	40	K30	895  RØ52	
<b>9844 9025</b> 9846 9650	<b>6417.00.00</b>	Spona upravljača Drag link Lenkstange  Izmenjivi delovi Parts list Stuckliste 5743.20.00	40	K30	878  RØ40	
<b>9847 2466</b>	<b>6342.00.00</b>	Vodica mosta Torque rod Achsstrebe Izmenjivi delovi  Parts list Stuckliste 5117.96.00	62	Ø19 >24< <130>	594  RØ46	
<b>9847 2871</b>	<b>5117.00.00</b>	Vodica mosta Torque rod Achsstrebe Izmenjivi delovi  Parts list Stuckliste 5117.96.00	62	Ø19 >24< <130>	595  RØ50	

Originalni broj Cross-Ref.-No. Original Nr.	Br. FAD No. No.	Naziv Designation Bezeichnung	Kugla Ball Ø Größe	Konus Taper Konus	Dužina Length Länge	Skica Figure Bild
<b>9847 3328</b>	<b>6420.00.00</b>	Spona upravljača Drag link Lenkstange  Izmenjivi delovi Parts list Stuckliste 5743.20.00	40	K30	966  RØ50	
<b>9847 5709</b>	<b>6427.00.00</b>	Spona upravljača Drag link Lenkstange  Izmenjivi delovi Parts list Stuckliste 5741.20.00	35	K26	1210  RØ52	
<b>9848 4091</b>	<b>6395.00.00</b>	Stabilizator Stabilizer link Koppelstang	35	K26	100  RØ32	
<b>9848 8010</b>	<b>5103.00.00</b>	Vođica mosta Torque rod Achsstrebe  Izmenjivi delovi Parts list Stuckliste 5170.96.00	70	Ø19 >30< <130>	583  RØ50	
<b>9849 3054</b>	<b>6428.00.00</b>	Spona upravljača Drag link Lenkstange Izmenjivi delovi Parts list Stuckliste 5743.20.00	40	K30	887  RØ40	
<b>9944 4744</b>	<b>6344.00.00</b>	Vođica mosta Torque rod Achsstrebe Izmenjivi delovi Parts list Stuckliste 5117.96.00	62	Ø19 >24< <130>	644  RØ50	



# KÄSSBOHRER

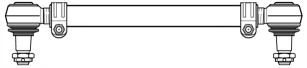

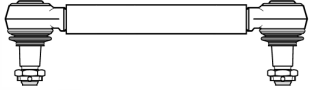
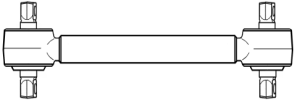
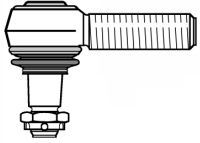
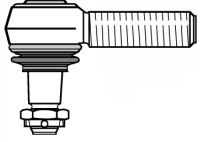

Originalni broj Cross-Ref.-No. Original Nr.	Br. FAD No. Nr.	Naziv Designation Bezeichnung	Kugla Ball Ø Größe	Konus Taper Konus	Dužina Length Länge	Skica Figure Bild
<b>628 330 04 03</b> 628 330 05 03	<b>6909.00.00</b>	Poprečna spona Tie rod Spurstange  Izmenljivi delovi Parts list Stuckliste 5741.10.00 5741.20.00	35	K26	768  RØ40	
<b>6.284.600.305</b>	<b>4576.00.00</b>	Spona upravljača Drag link Lenkstange	40	K30	928  RØ42	
<b>628 460 20 05</b>	<b>4595.00.00</b>	Poprečna spona Tie rod Spurstange	40	K30	566  RØ36	
<b>6.293.500.606</b> 8.226.293.000B	<b>6197.00.00</b>	Vođica mosta Torque rod Achsstrebe Izmenljivi delovi Parts list Stuck liste 5170.96.00	70	Ø19 >30< <130>	658  RØ50	
<b>6.851.446.000</b> 6.851.459.000 6.851.479.000 6.851.487.000 6.851.532.000	<b>5742.10.00</b>	Zglob,LH M30x1,5 Ball joint, LH Kugelgelenk, LH	40	K26	120	
<b>6.851.447.000</b> 6.851.478.000 6.851.486.000 6.851.488.000 6.851.523.000	<b>5742.20.00</b>	Zglob,RH M30x1,5 Ball joint, RH Kugelgelenk, RH	40	K26	120	

# KÄSSBOHRER



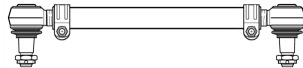
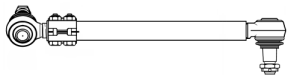

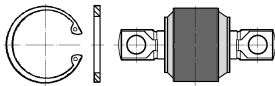
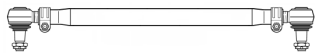
Originalni broj Cross-Ref.-No. Original Nr.	Br. FAD No. No.	Naziv Designation Bezeichnung	Kugla Ball Ø Größe	Konus Taper Konus	Dužina Length Länge	Skica Figure Bild
<b>6.851.475.000</b> 6.851.480.000 6.851.484.000 6.851.531.000 8.226.236.059	<b>5743.20.00</b>	Zglob,RH M30x1,5 Ball joint, RH Kugelgelenk, RH	40	K30	120	
<b>6.851.485.000</b> 8.226.236.058	<b>5743.10.00</b>	Zglob,LH M30x1,5 Ball joint, LH Kugelgelenk, LH	40	K30	120	
<b>6.851.490.000</b>	<b>3581.10.00</b>	Zglob,LH M38x1,5 Ball joint, LH Kugelgelenk, LH	50	K38	135	
<b>6.851.491.000</b>	<b>3581.20.00</b>	Zglob,RH M38x1,5 Ball joint, RH Kugelgelenk, RH	50	K38	135	
<b>6.851.517.000</b>	<b>5741.20.00</b>	Zglob,RH M30x1,5 Ball joint, RH Kugelgelenk, RH	35	K26	115	
<b>6.851.529.000</b>	<b>4911.20.00</b>	Zglob,RHM30x1. 5 * Ball joint,RH Kugelgelenk,RH	40	K30	120	
<b>8.226.137.000</b> 8.226.147.000C 8.226.305.000C 8.226.313.000C	<b>5686.00.00</b>	Spona upravljača Drag link Lenkstange	35	K26	380 RØ40	

Originalni broj Cross-Ref.-No. Original Nr.	Br. FAD No. Nr.	Naziv Designation Bezeichnung	Kugla Ball Ø Größe	Konus Taper Konus	Dužina Length Länge	Skica Figure Bild
<b>8.226.138.000</b> 8.226.148.000C	<b>5687.00.00</b>	Spona upravljača Drag link Lenkstange  Izmenljivi delovi Parts list Stuckliste 5742.20.00 5742.10.00	40	K26	655  RØ50	
<b>8.226.225.000D</b>	<b>6045.00.00</b>	Poprečna spona Tie rod Spurstange  Izmenljivi delovi Part list Stuckliste 3581.20.00	50	K38	647  RØ50	
<b>8.226.232.000</b> 8.226.241.000 8.226.357.000	<b>3491.00.00</b>	Vodica mosta Torque rod Achsstrebe Izmenljivi delovi Parts list Stuck liste 5170.96.00	70	Ø19 >30< <130>	660  RØ50	
<b>8.226.232.066.0</b>	<b>5170.96.00</b>	Izmenljivi podsklop Repair kit Reparatur satz	70	Ø19 >30<	<130>	
<b>8.226.238.000C</b>	<b>6048.00.00</b>	Spona upravljača Drag link Lenkstange  Izmenljivi delovi Part list Stuckliste 5743.20.00 5743.10.00	40	K30	1660  RØ50	

# KÄSSBOHRER

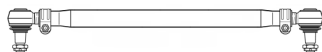

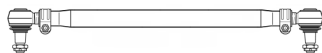
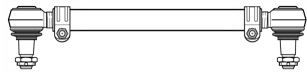
Originalni broj Cross-Ref.-No. Original Nr.	Br. FAD No. No. Nr.	Naziv Designation Bezeichnung	Kugla Ball Ø Größe	Konus Taper Konus	Dužina Length Länge	Skica Figure Bild
<b>8.226.257.000</b>	<b>6042.00.00</b>	Spona upravljača Drag link Lenkstange  Izmenljivi delovi Parts list Stuckliste 3581.20.00	50	K38	910  RØ50	
<b>8.226.259.000</b> 8.226.262.000 8.226.259.000C 8.226.262.000C	<b>3494.00.00</b>	Spona upravljača Drag link Lenkstange Izmenljivi delovi Parts list Stuckliste 5743.20.00 5743.10.00	40	K30	2165  RØ50	
<b>8.226.261.000C</b>	<b>6043.00.00</b>	Spona upravljača Drag link Lenkstange  Izmenljivi delovi Parts list Stuckliste 5743.20.00 5743.10.00	40	K30	1585  RØ50	
<b>8.226.280.000B</b> 8.226.280.000C 8.226.280.0000 8.226.355.000 8.226.355.0000	<b>4920.00.00</b>	Spona upravljača Drag link Lenkstange Izmenljivi delovi Parts list Stuckliste 4563.20.00 6321.10.00	40	K30	2175  RØ50	
<b>8.226.306.000</b> 8.226.244.000D 8.226.258.000C	<b>3492.00.00</b>	Poprečna spona Tie rod Spurstange  Izmenljivi delovi Parts list Stuckliste 5742.20.00 5742.10.00	40	K26	670  RØ40	

# KÄSSBOHRER



Originalni broj Cross-Ref.-No. Original Nr.	Br. FAD No. No. Nr.	Naziv Designation Bezeichnung	Kugla Ball Ø Größe	Konus Taper Konus	Dužina Length Länge	Skica Figure Bild
8.226.307.000 8.226.347.000 8.226.247.000C	6049.00.00	Poprečna spona Tie rod Spurstange	40	K30	484  RØ40	
8.226.308.000 8.226.308.000C 8.226.248.000C 8.226.381.000	4911.00.00	Poprečna spona Tie rod Spurstange  Izmenljivi delovi Part list Stuckliste 4911.20.00	40	K30	630  RØ40	
8.226.318.000B 8.226.323.000B	3497.00.00	Vođica mosta Torque rod Achsstrebe Izmenljivi delovi Parts list Stuckliste 5170.96.00	70	Ø19 >30< <130>	660  RØ50	
8.226.328.000	4912.00.00	Poprečna spona Tie rod Spurstange Izmenljivi delovi Part list Stuckliste 4911.20.00	40	K30	680  RØ40	
8.226.330.000	4915.00.00	Poprečna spona Tie rod Spurstange	40	K30	380  RØ40	
8.226.356.000	4913.00.00	Poprečna spona Tie rod Spurstange Izmenljivi delovi  Parts list Stuckliste 5743.20.00 5743.10.00	40	K30	2130  RØ50	

# KÄSSBOHRER

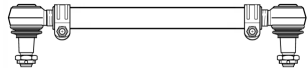
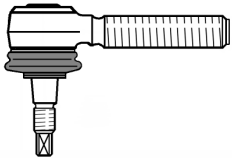
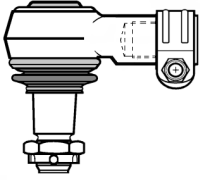

Originalni broj Cross-Ref.-No. Original Nr.	FAD Br. No. Nr.	Naziv Designation Bezeichnung	Kugla Ball Ø Größe	Konus Taper Konus	Dužina Length Länge	Skica Figure Bild
<b>8.226.380.000</b> 8.226.380.000C	<b>4914.00.00</b>	Spona upravljača Drag link Lenkstange Izmenljivi delovi Parts list Stuckliste 5855.20.00 5743.10.00	40	K32  K30	870  RØ40	
<b>8.321.999.319</b>	<b>3590.20.00</b>	Zglob, RH M14x1.5 Ball joint, RH Kugelgelenk, RH	22	K12	85	
<b>8.851.360.000</b>	<b>7476.20.00</b>	Zglob, RHM30x1.5 * Ball joint, RH Kugelgelenk, RH	40	K26	120	

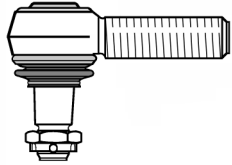
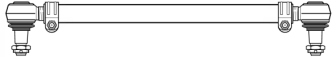
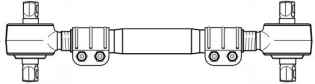
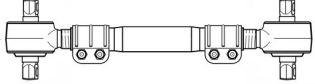
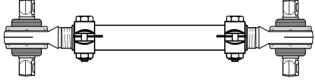
Originalni broj Cross-Ref.-No. Original Nr.	Br. FAD No. No.	Naziv Designation Bezeichnung	Kugla Ball Ø Größe	Konus Taper Konus	Dužina Length Länge	Skica Figure Bild
<b>1022 0897</b>	<b>3903.20.00</b>	Zglob, RH M30x1,5 Ball joint, RH Kugelgelenk, RH	35	K26	141	
<b>5211 346 77</b>	<b>6321.00.00</b>	Spona upravljača Drag link Lenkstange  Izmenjivi delovi Parts list Stuckliste 6321.10.00 4563.20.00	40	K30	1030 RØ40	
<b>5211 434 08</b>	<b>6105.00.00</b>	Vođica mosta Torque rod Achsstrebe  Izmenjivi delovi Parts list Stuckliste 6027.10.00 6027.20.00	66	Ø19 >30< <130>	620 RØ60	
<b>5211 435 08</b>	<b>6027.00.00</b>	Vođica mosta Torque rod Achsstrebe  Izmenjivi delovi Parts list Stuckliste 6027.10.00 6027.20.00	66	Ø19 >30< <130>	710 RØ60	
<b>5211 438 5211 438 08</b>	<b>6106.00.00</b>	Vođica mosta Torque rod Achsstrebe  Izmenjivi delovi Parts list Stuckliste 6106.10.00 6106.20.00	53	Ø17 >24< <115>	635 RØ50	

Originalni broj Cross-Ref.-No. Original Nr.	Br. FAD No. No.	Naziv Designation Bezeichnung	Kugla Ball Ø Größe	Konus Taper Konus	Dužina Length Länge	Skica Figure Bild
<b>5211 439 08</b>	<b>6100.00.00</b>	Vodica mosta Torque rod Achsstrebe  Izmenjivi delovi Parts list Stuckliste 6027.10.00 6027.20.00	66	Ø19 >30< <130>	900  RØ60	
<b>5211 440 08</b>	<b>6101.00.00</b>	Vodica mosta Torque rod Achsstrebe Izmenjivi delovi Parts list Stuckliste 6027.10.00 6027.20.00	66	Ø19 >30< <130>	550  RØ60	
<b>5211 441</b> 5211 441 08	<b>6102.00.00</b>	Vodica mosta Torque rod Achsstrebe Izmenjivi delovi Parts list Stuckliste 6027.10.00 6027.20.00	66	Ø19 >30< <130>	780  RØ60	
<b>5211 448</b> 5211 448 08	<b>6103.00.00</b>	Vodica mosta Torque rod Achsstrebe Izmenjivi delovi Parts list Stuckliste 6027.10.00 6027.20.00	66	Ø19 >30< <130>	750  RØ60	
<b>5211 543 08</b> 5211 543	<b>4484.96.00</b>	Izmenjivi podsklop Repair kit Reparatur satz	83	Ø25 >24<	<152>	

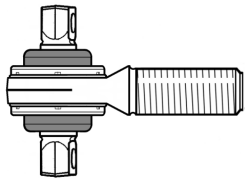
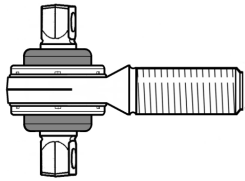
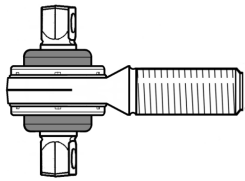
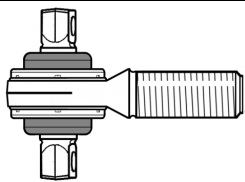
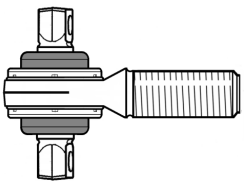
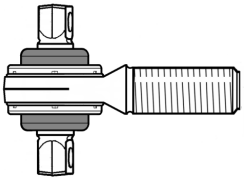
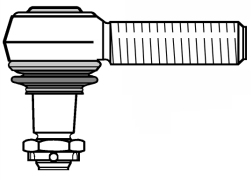

Originalni broj Cross-Ref.-No. Original Nr.	Br. FAD No. Nr.	Naziv Designation Bezeichnung	Kugla Ball Ø Größe	Konus Taper Konus	Dužina Length Länge	Skica Figure Bild
5708 158 08	6106.20.00	Zglob, RH 38x1,5 Ball joint, RH Kugelgelenk, RH	53	Ø17 >24<	150 <115>	
5708 159 08	6106.10.00	Zglob, LH M38x1,5 Ball joint, LH Kugelgelenk, LH	53	Ø17 >24<	150 <115>	
5708 160 08	6027.20.00	Zglob, RH M48x1,5 Ball joint, RH Kugelgelenk, RH	66	Ø19 >30<	200 <130>	
5708 161 08	6027.10.00	Zglob, LH M48x1,5 Ball joint, LH Kugelgelenk, LH	66	Ø19 >30<	200 <130>	
5708 196 08	6104.20.00	Zglob, RH M48x1,5 Ball joint, RH Kugelgelenk, RH	66	Ø21 >30<	200 <152>	
5708 197 08	6104.10.00	Zglob, LH M48x1,5 Ball joint, LH Kugelgelenk, LH	66	Ø21 >30<	200 <152>	
5718 665 08	5743.10.00	Zglob, LH M30x1,5 Ball joint, LH Kugelgelenk, LH	40	K30	120	

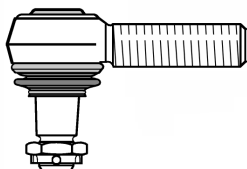
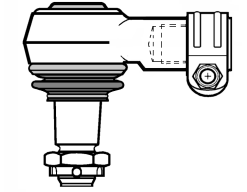
Originalni broj Cross-Ref.-No. Original Nr.	Br. FAD No. No.	Naziv Designation Bezeichnung	Kugla Ball Ø Größe	Konus Taper Konus	Dužina Length Länge	Skica Figure Bild
<b>5718 666 08</b>	<b>5743.20.00</b>	Zglob,RH M30x1,5 Ball joint, RH Kugelgelenk, RH	40	K30	120	
<b>7250 510 08</b>	<b>7474.20.00</b>	Zglob,RH M24x1,5 * Ball joint, RH Kugelgelenk, RH	40	K30	95	

Originalni broj Cross-Ref.-No. Original Nr.	Br. FAD No. Nr.	Naziv Designation Bezeichnung	Kugla Ball Ø Größe	Konus Taper Konus	Dužina Length Länge	Skica Figure Bild
<b>36 46610 6000</b>	<b>6699.00.00</b>	Poprečna spona Tie rod Spurstange Izmenjivi delovi Parts list Stuckliste 6321.10.00 4563.20.00	40	K30	300 RØ40	
<b>36 46710 6003</b> 36 46710 6005	<b>6698.00.00</b>	Poprečna spona Tie rod Spurstange Izmenjivi delovi Parts list Stuckliste 6321.10.00 4563.20.00	40	K30	753 RØ42	
<b>81 43220 6010</b> 81 43220 6012 81 43220 6013 81 43220 6018 81 43220 6020 81 43220 6028 81 43220 6035 81 43220 6040 81 43220 6041 81 43220 6052 81 43220 6056	<b>5910.00.00</b>	Vođica mosta Torque rod Achsstrebe  Izmenjivi delovi Parts list Stuckliste 5170.96.00	70	Ø19 >30< <130>	565 RØ50	
<b>81 43220 6015</b> 81 43220 6047	<b>6692.00.00</b>	Vođica mosta Torque rod Achsstrebe  Izmenjivi delovi Parts list Stuckliste 3284.96.00	55	Ø15 >24< <100>	550 RØ50	
<b>81 43220 6025</b>	<b>5948.00.00</b>	Vođica mosta Torque rod Achsstrebe  Izmenjivi delovi Parts list Stuckliste 5170.96.00	70	Ø19 >30< <130>	455 RØ50	

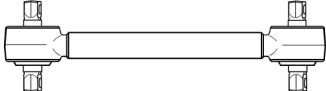
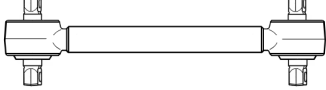
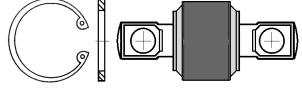
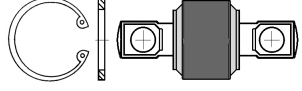
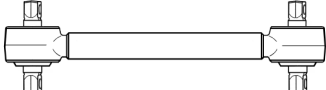
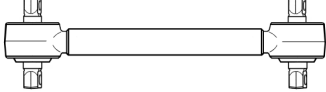
Originalni broj Cross-Ref.-No. Original Nr.	Br. FAD No. Nr.	Naziv Designation Bezeichnung	Kugla Ball Ø Größe	Konus Taper Konus	Dužina Length Länge	Skica Figure Bild
<b>81 43220 6042</b>	<b>5951.00.00</b>	Vodica mosta Torque rod Achsstrebe  Izmenjivi delovi Parts list Stuckliste 5170.96.00	70	Ø19 >30< <130>	762  RØ50	
<b>81 43220 6043</b>	<b>5952.00.00</b>	Vodica mosta Torque rod Achsstrebe  Izmenjivi delovi Parts list Stuckliste 5170.96.00	70	Ø19 >30< <130>	661  RØ50	
<b>81 43220 6053</b>	<b>5531.96.00</b>	Izmenjivi podsklop Repair kit Reparatur satz	78.5	Ø19 >40<	<130>	
<b>81 43220 6055</b> 81 43220 6073	<b>5170.96.00</b>	Izmenjivi podsklop Repair kit Reparatur satz	70	Ø19 >30<	<130>	
<b>81 43220 6067</b> 81 43220 6068 81 43220 6090 81 43220 6092 81 43220 9092	<b>5950.00.00</b>	Vodica mosta Torque rod Achsstrebe  Izmenjivi delovi Parts list Stuckliste 5170.96.00	70	Ø19 >30< <130>	590  RØ50	
<b>81 43220 6070</b> 81 43220 6071 81 43220 6072 81 43220 6091 81 43220 6093	<b>5938.00.00</b>	Vodica mosta Torque rod Achsstrebe  Izmenjivi delovi Parts list Stuckliste 5938.96.00	78.5	Ø19 >35< <130>	585  RØ58	

Originalni broj Cross-Ref.-No. Original Nr.	Br. FAD No. Nr.	Naziv Designation Bezeichnung	Kugla Ball Ø Größe	Konus Taper Konus	Dužina Length Länge	Skica Figure Bild
<b>81 43220 6096</b> 81 43220 6097 81 43220 6098 81 43220 6129 81 43230 6014 81 43230 6030	<b>5546.00.00</b>	Vođica mosta Torque rod Achsstrebe  Izmenjivi delovi Parts list Stuckliste 5546.96.00	62	Ø19 >30< <130>	571  RØ50	
<b>81 43220 6096</b> 81 43220 6097 81 43220 6098 81 43220 6129 81 43230 6014 81 43230 6030	<b>5921.00.00</b>	Vođica mosta Torque rod Achsstrebe  Izmenjivi delovi Parts list Stuckliste 3698.90.00	65	Ø19 >30< <130>	571  RØ50	
<b>81 43220 6096</b> 81 43220 6097 81 43220 6098 81 43220 6129 81 43230 6014 81 43230 6030	<b>5937.00.00</b>	Vođica mosta Torque rod Achsstrebe  Izmenjivi delovi Parts list Stuckliste 5170.96.00	70	Ø19 >30< <130>	570  RØ50	
<b>81 43220 6096</b> 81 43220 6097 81 43220 6098 81 43220 6129 81 43230 6014 81 43230 6030	<b>5941.00.00</b>	Vođica mosta Torque rod Achsstrebe  Izmenjivi delovi Parts list Stuckliste 3698.90.00	65	Ø19 >30< <130>	570  RØ50	
<b>81 43220 6096</b> 81 43220 6097 81 43220 6098 81 43220 6129 81 43230 6014 81 43230 6030	<b>5959.00.00</b>	Vođica mosta Torque rod Achsstrebe  Izmenjivi delovi Parts list Stuckliste 5959.90.00	65	Ø19 >30< <130>	571  RØ50	

Originalni broj Cross-Ref.-No. Original Nr.	Br. FAD No. Nr.	Naziv Designation Bezeichnung	Kugla Ball Ø Größe	Konus Taper Konus	Dužina Length Länge	Skica Figure Bild
81 43220 6099 81 43220 6100	5956.00.00	Vođica mosta Torque rod Achsstrebe Izmenjivi delovi Parts list Stuckliste 5170.96.00	70	Ø19 >30< <130>	750 RØ50	
81 43220 6102 81 43220 6148 81 43220 6152 81 43220 6186	5538.00.00	Vođica mosta Torque rod Achsstrebe Izmenjivi delovi Parts list Stuckliste 5170.96.00	70	Ø19 >30< <130>	670 RØ50	
81 43220 6106 81 43230 6049	6173.00.00	Vođica mosta Torque rod Achsstrebe Izmenjivi delovi Parts list Stuckliste 5323.96.00	62	Ø17 >24< <115>	777 RØ60	
81 43220 6108	5959.90.00	Izmenjivi podsklop Repair kit Reparatur satz	65	Ø19 >30<	<130>	
81 43220 6129	6181.00.00	Vođica mosta Torque rod Achsstrebe Izmenjivi delovi Parts list Stuckliste 5117.96.00	62	Ø19 >24< <130>	577 RØ50	
81 43220 6140 81 43220 9140	6186.00.00	Vođica mosta Torque rod Achsstrebe Izmenjivi delovi Parts list Stuckliste 5959.90.00	65/40	Ø19/ Ø18.5  >30</ >24<  <130>/ <102>	596 RØ50	

Originalni broj Cross-Ref.-No. Original Nr.	Br. FAD No. No. Nr.	Naziv Designation Bezeichnung	Kugla Ball Ø Größe	Konus Taper Konus	Dužina Length Länge	Skica Figure Bild
81 43220 6151 81 43220 6183 81 43220 6276	6194.00.00	Vodica mosta Torque rod Achsstrebe  Izmenjivi delovi Parts list Stuckliste 5942.96.00	70	Ø19 >24< <130>	570  RØ50	
81 43220 6161 81 43220 6190	4108.00.00	Vodica mosta Torque rod Achsstrebe  Izmenjivi delovi Parts list Stuckliste 5170.96.00	7	Ø19 >30< <130>	531  RØ50	
81 43220 6168	5339.00.00	Vodica mosta Torque rod Achsstrebe  Izmenjivi delovi Parts list Stuckliste 3935.96.00	55	Ø17 >20< <100>	570  RØ40	
81 43220 6174	6191.00.00	Vodica mosta Torque rod Achsstrebe Izmenjivi delovi Parts list Stuckliste 5959.90.00	65/40	Ø19/ Ø18.5  >30</ >24<  <130>/ <102>	644  RØ50	
81 43220 6189	4107.00.00	Vodica mosta Torque rod Achsstrebe Izmenjivi delovi Parts list Stuckliste 5170.96.00	70	Ø19 >30< <130>	614  RØ50	
81 43220 6196	4112.00.00	Vodica mosta Torque rod Achsstrebe Izmenjivi delovi Parts list Stuckliste 5942.96.00	70	Ø19 >24< <130>	596  RØ50	

Originalni broj Cross-Ref.-No. Original Nr.	Br. FAD No. Nr.	Naziv Designation Bezeichnung	Kugla Ball Ø Größe	Konus Taper Konus	Dužina Length Länge	Skica Figure Bild
<b>81 43220 6203</b>	<b>5594.90.00</b>	Izmenjivi podsklop Repair kit Reparatur satz	70	Ø21 >30<	<130>	
<b>81 43220 6229</b> 81 43220 6304 81 43220 6305	<b>6188.00.00</b>	Vođica mosta Torque rod Achsstrebe  Izmenjivi delovi Parts list Stuckliste 4569.96.00	62	Ø19 >24< <130>	572 RØ50	
<b>81 43220 6236</b> 81 43220 6267 81 43220 6272	<b>6188.00.00</b>	Vođica mosta Torque rod Achsstrebe  Izmenjivi delovi Parts list Stuckliste 5959.90.00	65	Ø19 >30< <130>	566 RØ50	
<b>81 43220 6247</b>	<b>6201.00.00</b>	Vođica mosta Torque rod Achsstrebe  Izmenjivi delovi Parts list Stuckliste 6201.90.00	65	Ø23 >30< <130>	414 RØ50	
<b>81 43220 6258</b> 81 43220 6264 81 43220 6275 81 43220 6278 81 43220 6279	<b>6683.00.00</b>	Vođica mosta Torque rod Achsstrebe  Izmenjivi delovi Parts list Stuckliste 5942.96.00	70	Ø19 >24< <130>	622 RØ50	
<b>81 43230 6015</b> 81 43230 6031 81 43230 9031	<b>5940.00.00</b>	Vođica mosta Torque rod Achsstrebe  Izmenjivi delovi Parts list Stuckliste 3698.90.00	65	Ø19 >30< <130>	595 RØ50	



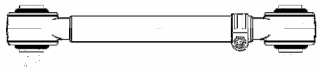
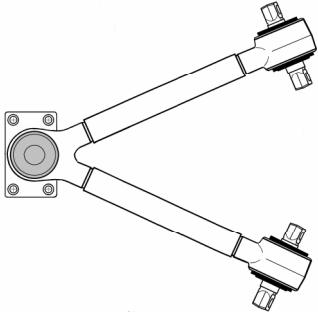
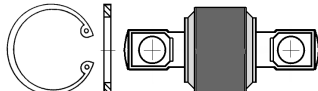
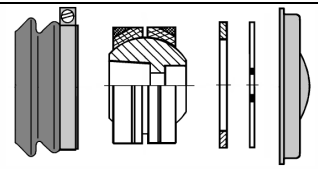
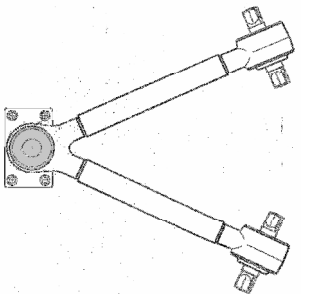

Originalni broj Cross-Ref.-No. Original Nr.	Br. FAD No. No. Nr.	Naziv Designation Bezeichnung	Kugla Ball Ø Größe	Konus Taper Konus	Dužina Length Länge	Skica Figure Bild
<b>81 43230 6037</b>	<b>3698.00.00</b>	Vodica mosta Torque rod Achsstrebe  Izmenjivi delovi Parts list Stuckliste 3698.90.00	65	Ø19 >30< <130>	500  RØ50	
<b>81 43230 6037</b>	<b>5537.00.00</b>	Vodica mosta Torque rod Achsstrebe  Izmenjivi delovi Parts list Stuckliste 5170.96.00	70	Ø19 >30< <130>	500  RØ50	
<b>81 43230 6038</b> 81 43230 6039	<b>5922.00.00</b>	Vodica mosta Torque rod Achsstrebe  Izmenjivi delovi Parts list Stuckliste 3698.90.00	65	Ø19 >30< <130>	750  RØ50	
<b>81 43230 6043</b>	<b>3698.90.00</b>	Izmenjivi podsklop Repair kit Reparatur satz	65	Ø19 >30<	<130>	
<b>81 43230 6051</b> 81 43230 6068 81 43270 6064	<b>5323.90.00</b>	Izmenjivi podsklop Repair kit Reparatur satz	62	Ø17 >24<	<115>	
<b>81 43230 6061</b>	<b>5117.96.00</b>	Izmenjivi podsklop Repair kit Reparatur satz	62	Ø19 >24<	<130>	
<b>81 43250 6007</b>	<b>5554.00.00</b>	Vodica mosta Torque rod Achsstrebe  Izmenjivi delovi Parts list Stuckliste 5554.20.00	40	Ø20	840  RØ40	

Originalni broj Cross-Ref.-No. Original Nr.	Br. FAD No. Nr.	Naziv Designation Bezeichnung	Kugla Ball Ø Größe	Konus Taper Konus	Dužina Length Länge	Skica Figure Bild
<b>81 43250 6014</b>	<b>4130.00.00</b>	Vodica mosta Torque rod Achsstrebe  Izmenjivi delovi Parts list Stuckliste 5554.20.00	40	Ø20	840 RØ40	
<b>81 43250 6016</b>	<b>4137.00.00</b>	Vodica mosta Torque rod Achsstrebe  Izmenjivi delovi Parts list Stuckliste 5554.20.00	40	Ø20	880 RØ40	
<b>81 43270 6030</b> 81 43270 6034 81 43270 6057 81 43270 6074 81 43270 6076 81 43270 6078 81 43270 6082 81 43270 9034 81 43270 9078	<b>5943.00.00</b>	V Vodica mosta Triangular torque rod Dreieckslenker  Izmenjivi delovi Parts list Stuckliste 5943.90.00 5945.90.00	65/80	Ø23 >35< <152> K46	621 RØ58	
<b>81 43270 6040</b> 81 43270 6045	<b>3765.96.00</b>	Izmenjivi podsklop Repair kit Reparatur satz	78.5	Ø21 >24<	<152>	
<b>81 43270 6047</b>	<b>3500.90.00</b>	Izmenjivi podsklop Repair kit Reparatur satz	80	K40		
<b>81 43270 6056</b> 81 43270 6067 81 43270 6075 81 43270 6077 81 43270 6081 81 43270 9056	<b>5944.00.00</b>	V Vodica mosta Triangular torque rod Dreieckslenker  Izmenjivi delovi Parts list Stuckliste 5943.90.00 5944.96.00	78.5	Ø23 >24< <152> K46	627 RØ58	

Originalni broj Cross-Ref.-No. Original Nr.	Br. FAD No. No. Nr.	Naziv Designation Bezeichnung	Kugla Ball Ø Größe	Konus Taper Konus	Dužina Length Länge	Skica Figure Bild
81 43270 6065	5524.90.00	Izmenjivi podsklop Repair kit Reparatur satz	65	K38		
81 43270 6096	6189.00.00	V Vođica mosta Triangular torque rod Dreieckslenker  Izmenjivi delovi Parts list Stuckliste 4103.96.00	80/70	Ø23 >24< <130> K46	627  RØ50	
81 43270 6105	4492.96.00	Izmenjivi podsklop Repair kit Reparatur satz	70	Ø25 >24<	<130>	
81 43270 6079	5944.96.00	Izmenjivi podsklop Repair kit Reparatur satz	80	Ø23 >24<	<152>	
81 43270 6117	6219.00.00	V Vođica mosta Torque rod Achsstrebe  Izmenjivi delovi Parts list Stuckliste 4492.90.00 5943.90.00	70/ 80	Ø25 >24< <130> K46	627  RØ58	
81 43315 6012	5535.00.00	Vođica mosta Torque rod Achsstrebe  Izmenjivi delovi Parts list Stuckliste 5535.10.00 5535.20.00	78.5	Ø34	652  RØ50	

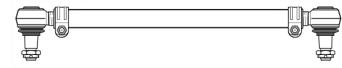
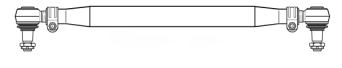
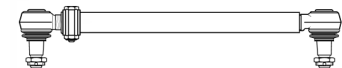
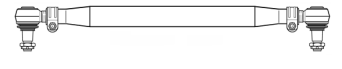
Originalni broj Cross-Ref.-No. Original Nr.	Br. FAD No. Nr.	Naziv Designation Bezeichnung	Kugla Ball Ø Größe	Konus Taper Konus	Dužina Length Länge	Skica Figure Bild
<b>81 43718 6006</b> 81 43718 6007	<b>5522.00.00</b>	Vođica mosta Torque rod Achsstrebe Izmenjivi delovi Parts list Stuckliste 5522.96.00	45	Ø15 >20< <90>	464 RØ40	
<b>81 43718 6009</b>	<b>5522.96.00</b>	Izmenjivi podsklop Repair kit Reparatur satz	45	Ø15 >20<	<90>	
<b>81 46610 6088</b> 81 46610 6288	<b>5520.00.00</b>	Spona upravljača Drag link Lenkstange  Izmenjivi delovi Parts list Stuckliste 5743.20.00	40	K30/ K26	800 RØ40	
<b>81 46610 6089</b> 81 46610 6291	<b>5539.00.00</b>	Spona upravljača Drag link Lenkstange  Izmenjivi delovi Parts list Stuckliste 5742.20.00	40	K26	815 RØ42	
<b>81 46610 6129</b>	<b>5335.00.00</b>	Spona upravljača Drag link Lenkstange Izmenjivi delovi Parts list Stuckliste 5743.20.00	40	K30	810 RØ40	
<b>81 46610 6147</b> 81 46610 6194 81 46610 6195 81 46610 6201 81 46610 6257 81 46610 6415 81 46610 6476 81 46610 6503 81 46610 6532 81 46610 6608 81 46610 6630	<b>5946.00.00</b>	Spona upravljača Drag link Lenkstange  Izmenjivi delovi Parts list Stuckliste 5743.10.00 5743.20.00	40	K30	1853 RØ52	





Originalni broj Cross-Ref.-No. Original Nr.	Br. FAD No. Nr.	Naziv Designation Bezeichnung	Kugla Ball Ø Größe	Konus Taper Konus	Dužina Length Länge	Skica Figure Bild
<b>81 46610 6159</b> 81 46610 6200 81 46610 6275 81 46610 6317 81 46611 6064 81 46610 6319	<b>5219.00.00</b>	Spona upravljača Drag link Lenkstange  Izmenjivi delovi Parts list Stuckliste 5743.10.00 5743.20.00	40	K30	710 RØ40	
<b>81 46610 6196</b> 81 46610 6202 81 46610 6258 81 46610 6409 81 46610 6504 81 46610 6531 81 46610 6593 81 46610 6609 81 46610 6631 81 46610 6740	<b>5932.00.00</b>	Spona upravljača Drag link Lenkstange  Izmenjivi delovi Parts list Stuckliste  5743.10.00 5743.20.00	40	K30	1953 RØ52	
<b>81.46610.6281</b> 81.46610.6300 81.46610.6303 81.46610.6304 81.46610.6327 81.46610.6329	<b>4152.00.00</b>	Spona upravljača Drag link Lenkstange Izmenjivi delovi Parts list Stuckliste 5805.20.00	30	K20	785 RØ30	
<b>81 46610 6292</b> 81 46610 6424 81 46610 6432 81 46610 6434 81 46610 6437 81 46610 6513 81 46610 6537 81 46610 6596 81 46610 6614 81 46610 6635 81 46610 6735 81 46610 6743	<b>5235.00.00</b>	Spona upravljača Drag link Lenkstange  Izmenjivi delovi Parts list Stuckliste  5743.10.00 5743.20.00	40	K30	1922 RØ50	
<b>81 46610 6301</b> 81 46610 6305 81 46610 6328	<b>5534.00.00</b>	Spona upravljača Drag link Lenkstange  Izmenjivi delovi Parts list Stuckliste 5746.20.00	30	K22	785 RØ40	





Originalni broj Cross-Ref.-No. Original Nr.	Br. FAD No. Nr.	Naziv Designation Bezeichnung	Kugla Ball Ø Größe	Konus Taper Konus	Dužina Length Länge	Skica Figure Bild
<b>81 46610 6333</b> 81 46610 6334 81 46610 6354 81 46610 6355 81 46610 6360 81 46610 6361 81 46610 6721 81 46610 6722 81 46610 6723	<b>5536.00.00</b>	Spona upravljača Drag link Lenkstange  Izmenjivi delovi Parts list Stuckliste 5743.20.00	40	K30	1030 RØ50	
<b>81 46610 6348</b>	<b>4118.00.00</b>	Poprečna spona Tie rod Spurstange Izmenjivi delovi Parts list Stuckliste 5743.10.00 5743.20.00	40	K30	770 RØ42	
<b>81 46610 6374</b> 81 46611 6019	<b>5975.00.00</b>	Spona upravljača Drag link Lenkstange Izmenjivi delovi Parts list Stuckliste 5743.10.00 5743.20.00	40	K30	1050 RØ42	
<b>81 46610 6376</b>	<b>6206.00.00</b>	Spona upravljača Drag link Lenkstange Izmenjivi delovi Parts list Stuckliste 5743.20.00	40	K30	1400 RØ40	
<b>81 46610 6414</b>	<b>5532.00.00</b>	Spona upravljača Drag link Lenkstange Izmenjivi delovi Parts list Stuckliste 5741.20.00	35	K26	930 RØ40	
<b>81 46610 6425</b> 81 46610 6436 81 46610 6515 81 46610 6538 81 46610 6597 81 46610 6615 81 46610 6634	<b>4165.00.00</b>	Spona upravljača Drag link Lenkstange Izmenjivi delovi Parts list Stuckliste 6321.10.00 4563.20.00	40	K30	1780 RØ50	

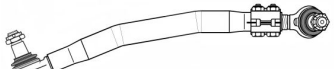

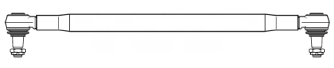
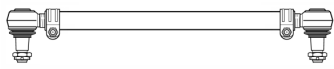
Originalni broj Cross-Ref.-No. Original Nr.	Br. FAD No. No. Nr.	Naziv Designation Bezeichnung	Kugla Ball Ø Größe	Konus Taper Konus	Dužina Length Länge	Skica Figure Bild
<b>81 46610 6548</b> 81 46611 6065	<b>6691.00.00</b>	Spona upravljača Drag link Lenkstange Izmenjivi delovi Parts list Stuckliste 5743.20.00	40	K30	610 RØ40	
<b>81 46610 6565</b> 81 46610 6567 81 46610 6569 81 46610 6621 81 46610 6639	<b>4164.00.00</b>	Spona upravljača Drag link Lenkstange Izmenjivi delovi Parts list Stuckliste 6321.10.00 4563.20.00	40	K30	912 RØ42	
<b>81.46610.6578</b> 81.46610.6798 81.46610.6876	<b>4145.00.00</b>	Spona upravljača Drag link Lenkstange Izmenjivi delovi Parts list Stuckliste 5743.10.00 5743.20.00	40	K30	755 RØ40	
<b>81 46610 6579</b> 81 46711 6720	<b>6694.00.00</b>	Poprečna spona Tie rod Spurstange Izmenjivi delovi Parts list Stuckliste 6321.10.00 4563.20.00	40	K30	1530 RØ50	
<b>81 46610 6584</b>	<b>4166.00.00</b>	Spona upravljača Drag link Lenkstange Izmenjivi delovi Parts list Stuckliste 4563.20.00	40	K30	870 RØ40	
<b>81 46610 6606</b>	<b>4097.00.00</b>	Spona upravljača Drag link Lenkstange Izmenjivi delovi Parts list Stuckliste 4563.20.00	40	K30	1270 RØ50	

Originalni broj Cross-Ref.-No. Original Nr.	Br. FAD No. Nr.	Naziv Designation Bezeichnung	Kugla Ball Ø Größe	Konus Taper Konus	Dužina Length Länge	Skica Figure Bild
<b>81 46610 6643</b>	<b>6221.00.00</b>	Spona upravljača Drag link Lenkstange Izmenjivi delovi Parts list Stuckliste 5743.20.00	40	K30	1140 RØ50	
<b>81 46610 6648</b> 81 46611 6150	<b>6681.00.00</b>	Spona upravljača Drag link Lenkstange  Izmenjivi delovi Parts list Stuckliste 5743.20.00	40	K30	1145  RØ50	
<b>81 46610 6656</b> 81 46610 6659	<b>5259.00.00</b>	Spona upravljača Drag link Lenkstange Izmenjivi delovi Parts list Stuckliste 5743.20.00	40	K30	1070 RØ50	
<b>81 46610 6660</b>	<b>4167.00.00</b>	Spona upravljača Drag link Lenkstange  Izmenjivi delovi Parts list Stuckliste 4563.20.00	40	K30	1000  RØ40	
<b>81 46610 6689</b> 81 46610 6720	<b>6203.00.00</b>	Poprečna spona Tie rod Spurstange Izmenjivi delovi  Parts list Stuckliste 5743.10.00 5743.20.00	40	K30	1406  RØ50	
<b>81 46610 6708</b> 81 46611 6067	<b>6198.00.00</b>	Spona upravljača Drag link Lenkstange Izmenjivi delovi Parts list Stuckliste 5743.20.00	40	K30	905 RØ52	

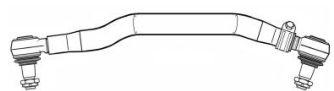
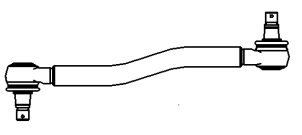

Originalni broj Cross-Ref.-No. Original Nr.	Br. FAD No. Nr.	Naziv Designation Bezeichnung	Kugla Ball Ø Größe	Konus Taper Konus	Dužina Length Länge	Skica Figure Bild
<b>81 46610 6716</b> 81 46611 6068	<b>6202.00.00</b>	Spona upravljača Drag link Lenkstange Izmenjivi delovi Parts list Stuckliste 5743.20.00	40	K30	745 RØ50	
<b>81 46610 6725</b> 85 46610 6030 85 46610 6102 85 46610 6201	<b>4115.00.00</b>	Spona upravljača Drag link Lenkstange Izmenjivi delovi Parts list Stuckliste 7414.20.00	30	K20	825 RØ32	
<b>81 46610 6753</b> 81 46610 6754 85 46610 6104	<b>4116.00.00</b>	Spona upravljača Drag link Lenkstange  Izmenjivi delovi Parts list Stuckliste 5746.20.00	30	K22	815 RØ40	
<b>81 46610 6756</b>	<b>6211.00.00</b>	Spona upravljača Drag link Lenkstange	40	K30	921 RØ60	
<b>81 46610 6761</b>	<b>4169.00.00</b>	Spona upravljača Drag link Lenkstange	40	K30	687 RØ50	
<b>81 46610 6767</b> 81 46610 6768 81 46611 6014	<b>7685.00.00</b>	Spona upravljača Drag link Lenkstange  Izmenjivi delovi Parts list Stuckliste 5743.10.00 5743.20.00	40	K30	900 RØ40	

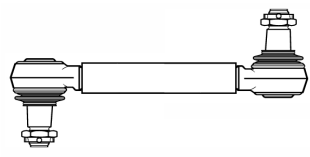
Originalni broj Cross-Ref.-No. Original Nr.	Br. FAD No. Nr.	Naziv Designation Bezeichnung	Kugla Ball Ø Größe	Konus Taper Konus	Dužina Length Länge	Skica Figure Bild
<b>81 46610 6779</b> 81 46610 6780 81 46610 6782	<b>6212.00.00</b>	Spona upravljača Drag link Lenkstange  Izmenjivi delovi Parts list Stuckliste 5536.20.00	40	K30	1060 RØ50	
<b>81 46610 6790</b> 81 46610 6791 82 46610 6191	<b>4136.00.00</b>	Spona upravljača Drag link Lenkstange	40	K30	1749 RØ52	
<b>81 46610 6803</b>	<b>6325.00.00</b>	Spona upravljača Drag link Lenkstange  Izmenjivi delovi Parts list Stuckliste 5741.20.00	35	K26	1340 RØ40	
<b>81 46611 6004</b> 81 46611 6005	<b>6224.00.00</b>	Poprečna spona Tie rod Spurstange  Izmenjivi delovi Parts list Stuckliste 5743.20.00	40	K30	1063 RØ42	
<b>81 46611 6045</b>	<b>6689.00.00</b>	Poprečna spona Tie rod Spurstange	40	K30	628 RØ40	
<b>81 46611 6096</b>	<b>6196.00.00</b>	Spona upravljača Drag link Lenkstange  Izmenjivi delovi Parts list Stuckliste 5743.20.00	40	K30	960 RØ52	

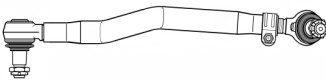
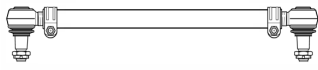



Originalni broj Cross-Ref.-No. Original Nr.	Br. FAD No. Nr.	Naziv Designation Bezeichnung	Kugla Ball Ø Größe	Konus Taper Konus	Dužina Length Länge	Skica Figure Bild
<b>81 46611 6108</b>	<b>6688.00.00</b>	Poprečna spona Tie rod Spurstange  Izmenjivi delovi Parts list Stuckliste 4126.20.00	40	K30	1358  RØ52	
<b>81 46611 6131</b>	<b>6687.00.00</b>	Spona upravljača Drag link Lenkstange	35	K26	745  RØ40	
<b>81 46611 6133</b>	<b>6223.00.00</b>	Spona upravljača Drag link Lenkstange Izmenjivi delovi Parts list Stuckliste 4126.20.00	40	K30	993  RØ52	
<b>81 46611 6138</b> 81 46611 6139 81 46611 6201 81 46611 6202	<b>6684.00.00</b>	Spona upravljača Drag link Lenkstange  Izmenjivi delovi Parts list Stuckliste 4126.20.00	40	K30	1021  RØ52	
<b>81 46611 6151</b> 82 46610 6184 82 46610 6185	<b>4153.00.00</b>	Spona upravljača Drag link Lenkstange Izmenjivi delovi Parts list Stuckliste 5743.10.00 5743.20.00	40	K30	993  RØ40	

Originalni broj Cross-Ref.-No. Original Nr.	Br. FAD No. No. Nr.	Naziv Designation Bezeichnung	Kugla Ball Ø Größe	Konus Taper Konus	Dužina Length Länge	Skica Figure Bild
81 46611 6157 81 46611 6158 81 46611 6159	6321.00.00	Spona upravljača Drag link Lenkstange Izmenjivi delovi Parts list Stuckliste 6321.10.00 4563.20.00	40	K30	1030 RØ40	
81 46611 6197 81 46611 6198	6216.00.00	Spona upravljača Drag link Lenkstange Izmenjivi delovi Parts list Stuckliste 4126.20.00	40	K30	993 RØ52	
81 46611 6199 81 46611 6200	4131.00.00	Spona upravljača Drag link Lenkstange Izmenjivi delovi Parts list Stuckliste 4126.20.00	40	K30	967 RØ52	
81 46611 6217 83 46610 6001	6252.00.00	Spona upravljača Drag link Lenkstange Izmenjivi delovi Parts list Stuckliste 6252.20.00	40	K30	1103 RØ50	
81.46710.6037 81.46710.6054 81.46710.6059 81 46710 6145 81.46710.6302	6179.00.00	Spona upravljača Drag link Lenkstange Izmenjivi delovi Parts list Stuckliste 5743.10.00 5743.20.00	40	K30	1690 RØ40	
81 46710 6080 81 46710 6136 81 46710 6172 81 46710 6295 81 46710 6337 81 46710 6345 81 46710 6421 81 46710 6451 81 46710 6876	5933.00.00	Poprečna spona Tie rod Spurstange  Izmenjivi delovi Parts list Stuckliste 5743.10.00 5743.20.00	40	K30	501  RØ40	

Originalni broj Cross-Ref.-No. Original Nr.	Br. FAD No. Nr.	Naziv Designation Bezeichnung	Kugla Ball Ø Größe	Konus Taper Konus	Dužina Length Länge	Skica Figure Bild
<b>81 46710 6081</b> 81 46710 6137 81 46710 6173 81 46710 6294 81 46710 6419 81 46710 6444 81 46710 6759 81 46710 6760 81 46710 6761 81 46710 6877 81 46710 6879	<b>5934.00.00</b>	Poprečna spona Tie rod Spurstange	40	K30	729  RØ40	
<b>81 46710 6112</b> 81 46710 6163 81 46710 6165 81 46710 6198 81 46710 6353 81 46710 6354 81 46710 6361 81 46711 6725	<b>5216.00.00</b>	Poprečna spona Tie rod Spurstange Izmenjivi delovi Parts list Stuckliste 5743.10.00 5743.20.00	40	K30	1652  RØ50	
<b>81 46710 6117</b> 81 46710 6281 81 46710 6282 81 46710 6370 81 46710 6371 81 46710 6372	<b>4104.00.00</b>	Poprečna spona Tie rod Spurstange Izmenjivi delovi Parts list Stuckliste 5741.10.00 5741.20.00	35	K26	1605  RØ36	
<b>81 46710 6131</b> 81 46710 6265 81 46710 6266 81 46710 6359 81 46710 6360 81 46710 6362 81 46710 6396 81 46710 6397 81 46710 6816 81 46710 6904 81 46711 6724	<b>5564.00.00</b>	Poprečna spona Tie rod Spurstange  Izmenjivi delovi Parts list Stuckliste 5743.20.00	40	K30	1628  RØ50	
<b>81 46710 6167</b> 81 46710 6194 81 46710 6195 81 46710 6378 81 46710 6379 81 46710 6380 81 46710 6830 81 46710 6836 81 46710 6912 81 46711 6736	<b>4134.00.00</b>	Poprečna spona Tie rod Spurstange  Izmenjivi delovi Parts list Stuckliste 5743.20.00	40	K30	1588  RØ52	

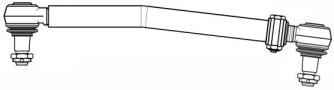
Originalni broj Cross-Ref.-No. Original Nr.	Br. FAD No. No. Nr.	Naziv Designation Bezeichnung	Kugla Ball Ø Größe	Konus Taper Konus	Dužina Length Länge	Skica Figure Bild
<b>81 46710 6175</b> 81 46710 6242 81 46710 6251 81 46710 6420	<b>3777.00.00</b>	Poprečna spona Tie rod Spurstange	40	K30	786  RØ40	
<b>81 46710 6176</b> 81 46710 6340 81 46710 6344 81 46710 6422	<b>3776.00.00</b>	Poprečna spona Tie rod Spurstange  Izmenjivi delovi Parts list Stuckliste 5743.10.00 5743.20.00	40	K30	399  RØ40	
<b>81 46710 6236</b> 81 46710 6267 81 46710 6268 81 46710 6355 81 46710 6356 81 46710 6373 81 46711 6723	<b>5210.00.00</b>	Poprečna spona Tie rod Spurstange  Izmenjivi delovi Parts list Stuckliste 5743.10.00 5743.20.00	40	K30	1692  RØ50	
<b>81 46710 6237</b> 81 46710 6239 81 46710 6241	<b>6697.00.00</b>	Poprečna spona Tie rod Spurstange  Izmenjivi delovi Parts list Stuckliste 5805.10.00 5805.20.00	30	K20	1520  RØ30	
<b>81 46710 6238</b> 81 46710 6240 81 46710 6409 81 46710 6410	<b>5245.00.00</b>	Poprečna spona Tie rod Spurstange  Izmenjivi delovi Parts list Stuckliste 5746.10.00 5746.20.00	30	K22	1430  RØ36	

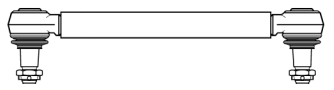
Originalni broj Cross-Ref.-No. Original Nr.	Br. FAD No. Nr.	Naziv Designation Bezeichnung	Kugla Ball Ø Größe	Konus Taper Konus	Dužina Length Länge	Skica Figure Bild
<b>81 46710 6253</b> 81 46710 6254 81 46710 6255 81 46710 6375 81 46710 6376 81 46710 6377 81 46710 6928 81 46711 6734 81 46711 6833	<b>6322.00.00</b>	Poprečna spona Tie rod Spurstange  Izmenjivi delovi Parts list Stuckliste 6321.10.00 4563.20.00	40	K30	1588  RØ50	
<b>81 46710 6314</b> 81 46710 6315 81 46710 6316	<b>4162.00.00</b>	Poprečna spona Tie rod Spurstange  Izmenjivi delovi Parts list Stuckliste 5741.10.00 5741.20.00	35	K26	1545  RØ40	
<b>81 46710 6388</b> 81 46710 6393	<b>5215.00.00</b>	Poprečna spona Tie rod Spurstange  Izmenjivi delovi Parts list Stuckliste 5741.10.00 5741.20.00	35	K26	1585  RØ46	
<b>81 46710 6418</b>	<b>6222.00.00</b>	Poprečna spona Tie rod Spurstange Izmenjivi delovi Parts list Stuckliste 5743.20.00	40	K30	1795  RØ50	
<b>81 46710 6434</b> 81 46710 6435 81 46710 6456	<b>5333.00.00</b>	Spona upravljača Drag link Lenkstange Izmenjivi delovi Parts list Stuckliste 5741.20.00	35	K26	904 RØ50	

Originalni broj Cross-Ref.-No. Original Nr.	Br. FAD No. Nr.	Naziv Designation Bezeichnung	Kugla Ball Ø Größe	Konus Taper Konus	Dužina Length Länge	Skica Figure Bild
<b>81 46710 6436</b>	<b>6213.00.00</b>	Spona upravljača Drag link Lenkstange Izmenjivi delovi Parts list Stuckliste 5741.20.00	35	K26	895 RØ40	
<b>81 46710 6438</b> 81 46710 6439	<b>6214.00.00</b>	Spona upravljača Drag link Lenkstange Izmenjivi delovi Parts list Stuckliste 5741.20.00	35	K26	1000 RØ40	
<b>81 46710 6443</b>	<b>6207.00.00</b>	Poprečna spona Tie rod Spurstange Izmenjivi delovi Parts list Stuckliste 5743.20.00	40	K30	1005 RØ42	
<b>81 46710 6453</b> 81 46710 6457 81 46710 6458 81 46710 6875 81 46710 6881 81 46711 6765 81 46711 6766 81 46711 6767	<b>4123.00.00</b>	Poprečna spona Tie rod Spurstange	40	K30	699 RØ40	
<b>81 46710 6459</b> 81 46710 6818 81 46710 6908	<b>5976.00.00</b>	Poprečna spona Tie rod Spurstange Izmenjivi delovi Parts list Stuckliste 5741.20.00	35	K26	1725 RØ50	
<b>81 46710 6459</b>	<b>5977.00.00</b>	Poprečna spona Tie rod Spurstange Izmenjivi delovi Parts list Stuckliste 5741.20.00	35	K26	1717 RØ50	



Originalni broj Cross-Ref.-No. Original Nr.	Br. FAD No. Nr.	Naziv Designation Bezeichnung	Kugla Ball Ø Größe	Konus Taper Konus	Dužina Length Länge	Skica Figure Bild
<b>81 46710 6851</b> 81 46710 6852 81 46711 6719 81 46711 6729	<b>4119.00.00</b>	Poprečna spona Tie rod Spurstange Izmenjivi delovi Parts list Stuckliste 5746.10.00 5746.20.00	30	K22	1620  RØ36	
<b>81 46710 6862</b> 81 46710 6863 81 46710 6864 81 46710 6909 81 46710 6910 81 46710 6974 81 46711 6786	<b>6792.00.00</b>	Poprečna spona Tie rod Spurstange Izmenjivi delovi Parts list Stuckliste 6791.20.00	35	K26	1698  RØ50	
<b>81 46710 6865</b> 81 46710 6866 81 46711 6728	<b>5332.00.00</b>	Poprečna spona Tie rod Spurstange Izmenjivi delovi Parts list Stuckliste 5805.10.00 5805.20.00	30	K20	1645  RØ30	
<b>81 46710 6918</b> 81 46711 6740 82 46710 6031	<b>4094.00.00</b>	Poprečna spona Tie rod Spurstange Izmenjivi delovi Parts list Stuckliste 5743.20.00	40	K30	1585  RØ60	
<b>81 46710 6966</b> 81 46711 6714	<b>4133.00.00</b>	Poprečna spona Tie rod Spurstange Izmenjivi delovi Parts list Stuckliste 4133.20.00	40	K30	1625  RØ50	
<b>81 46710 6994</b> 81 46711 6726	<b>6215.00.00</b>	Poprečna spona Tie rod Spurstange  Izmenjivi delovi Parts list Stuckliste 5743.20.00	40	K30	1664  RØ50	

Originalni broj Cross-Ref.-No. Original Nr.	Br. FAD No. Nr.	Naziv Designation Bezeichnung	Kugla Ball Ø Größe	Konus Taper Konus	Dužina Length Länge	Skica Figure Bild
<b>81 46711 6711</b>	<b>4132.00.00</b>	Poprečna spona Tie rod Spurstange Izmenjivi delovi Parts list Stuckliste 6791.20.00	35	K26	1650 RØ50	
<b>81 46711 6715</b> 81 46711 6823	<b>6791.00.00</b>	Poprečna spona Tie rod Spurstange  Izmenjivi delovi Parts list Stuckliste 6791.20.00	35	K26	1700 RØ52	
<b>81 46711 6770</b> 81 46711 6772 81 46711 6782 81 46711 6783 81 46711 6874 81 46711 6876	<b>4096.00.00</b>	Poprečna spona Tie rod Spurstange Izmenjivi delovi Parts list Stuckliste 5743.10.00 5743.20.00	40	K30	661 RØ30	
<b>81 46711 6771</b> 81 46711 6877 81 46711 6878 81 46711 6879	<b>4147.00.00</b>	Poprečna spona Tie rod Spurstange	40	K30	413 RØ36	
<b>81 46711 6773</b> 81 46711 6858	<b>6218.00.00</b>	Poprečna spona Tie rod Spurstange Izmenjivi delovi Parts list Stuckliste 6832.20.00	40	K30	1680 RØ50	
<b>81 46711 6802</b> 81 46711 6804 81 46711 6808 81 46711 6891 81 46711 6892 81 46711 6895	<b>4148.00.00</b>	Poprečna spona Tie rod Spurstange Izmenjivi delovi Parts list Stuckliste 5746.10.00 5746.20.00	30	K22	1666 RØ36	



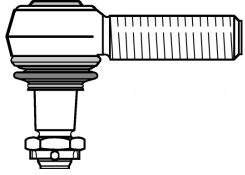
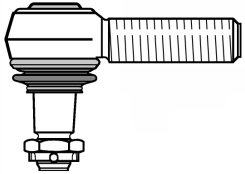
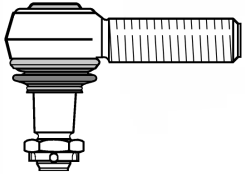
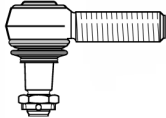

Originalni broj Cross-Ref.-No. Original Nr.	Br. FAD No. Nr.	Naziv Designation Bezeichnung	Kugla Ball Ø Größe	Konus Taper Konus	Dužina Length Länge	Skica Figure Bild
<b>81 46711 6803</b> 81 46711 6893 81 46711 6894 81 46711 6896	<b>6690.00.00</b>	Poprečna spona Tie rod Spurstange Izmenjivi delovi Parts list Stuckliste 5746.10.00 5746.20.00	30	K22	1632  RØ40	
<b>81 46711 6860</b> 81 46711 6861 81 46711 6883 81 46711 6921	<b>4135.00.00</b>	Poprečna spona Tie rod Spurstange Izmenjivi delovi Parts list Stuckliste 6832.20.00	40	K30	1679  RØ52	
<b>81 46711 6933</b> 81 46711 6934	<b>6323.00.00</b>	Poprečna spona Tie rod Spurstange Izmenjivi delovi Parts list Stuckliste 6321.10.00 4563.20.00	40	K30	1680  RØ42	
<b>81 95301 0013</b> 81 95301 0074 81 95301 6163 81 95301 6068 90 80415 3113 90 80415 3107	<b>5741.10.00</b>	Zglob, LH M30x1.5 Ball joint, LH Kugelgelenk, LH	35	K26	115	
<b>81 95301 0014</b> 81 95301 0064 81 95301 6239 81 95301 6067 81 95301 6162 90 80415 3111	<b>5741.20.00</b>	Zglob, RH M30x1.5 Ball joint, RH Kugelgelenk, RH	35	K26	115	
<b>81 95301 0015</b> 81 95301 0083 81 95301 0087 81 95301 6030 81 95301 6043 81 95301 6050 81 95301 6054 81 95301 6087 81 95301 6091 81 95301 6155 81 95301 6168 81 95301 6179 81 95301 6237 81 95301 6279	<b>5743.10.00</b>	Zglob, LH M30x1.5 Ball joint, LH Kugelgelenk, LH	40	K30	120	

Originalni broj Cross-Ref.-No. Original Nr.	Br. FAD No. Nr.	Naziv Designation Bezeichnung	Kugla Ball Ø Größe	Konus Taper Konus	Dužina Length Länge	Skica Figure Bild
<b>81 95301 0016</b> 81 95301 0084 81 95301 6048 81 95301 6049 81 95301 6053 81 95301 6090 81 95301 6108 81 95301 6112 81 95301 6126 81 95301 6143 81 95301 6149 81 95301 6154 81 95301 6156 81 95301 6178 81 95301 6194 81 95301 6224 81 95301 6234 81 95301 6274	<b>5743.20.00</b>	Zglob,RH M30x1.5 Ball joint, RH Kugelgelenk, RH	40	K30	120	
<b>81 95301 0022</b>	<b>5810.20.00</b>	Zglob,RH M30x1.5 Ball joint, RH Kugelgelenk, RH	50	K30	135	
<b>81 95301 0025</b> 90 80415 4117	<b>5742.20.00</b>	Zglob,RH M30x1.5 Ball joint, RH Kugelgelenk, RH	40	K26	120	
<b>81 95301 0038</b> 81 95301 0045 81 95301 6016 81 95301 6169 81 95301 6172 81 95301 6176	<b>3590.20.00</b>	Zglob,RH M14x1.5 Ball joint, RH Kugelgelenk, RH	22	K12	85	



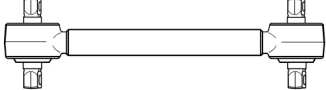
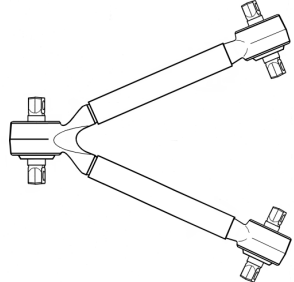

Originalni broj Cross-Ref.-No. Original Nr.	Br. FAD No. Nr.	Naziv Designation Bezeichnung	Kugla Ball Ø Größe	Konus Taper Konus	Dužina Length Länge	Skica Figure Bild
<b>81 95301 0040</b>	<b>5336.20.00</b>	Zglob, RH M22x1.5* Ball joint, RH Kugelgelenk, RH	40	K30	80	
<b>81 95301 0077</b> 81 95301 6134 81 95301 6142 81 95301 6321	<b>5805.20.00</b>	Zglob, RH M24x1.5 Ball joint, RH Kugelgelenk, RH	30	K20	95	
<b>81 95301 0078</b> 81 95301 6304 81 95301 6141 81 95301 6322	<b>5805.10.00</b>	Zglob, LH M24x1.5 Ball joint, LH Kugelgelenk, LH	30	K20	95	
<b>81 95301 0079</b> 81 95301 6139 81 95301 6222	<b>5746.10.00</b>	Zglob, LH M28x1.5 Ball joint, LH Kugelgelenk, LH	30	K22	105	
<b>81 95301 6060</b> 81 95301 6135 81 95301 6140 81 95301 6249	<b>5746.20.00</b>	Zglob, RH M28x1.5 Ball joint, RH Kugelgelenk, RH	30	K22	105	
<b>81 95301 6070</b> 81 95301 6261	<b>5742.10.00</b>	Zglob, LH M30x1.5 Ball joint, LH Kugelgelenk, LH	40	K26	120	

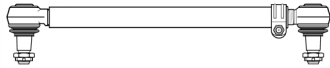
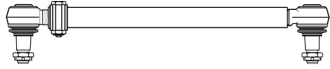
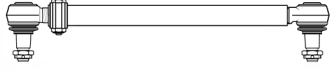

Originalni broj Cross-Ref.-No. Original Nr.	Br. FAD No. Nr.	Naziv Designation Bezeichnung	Kugla Ball Ø Größe	Konus Taper Konus	Dužina Length Länge	Skica Figure Bild
<b>81 95301 6132</b>	<b>5943.90.00</b>	Izmenjivi podsklop Repair kit Reparatur satz	80	K46		
<b>81 95301 6133</b>	<b>5945.90.00</b>	Izmenjivi podsklop Repair kit Reparatur satz	80	Ø23 >35<	<152>	
<b>81 95301 6184</b>	<b>5856.20.00</b>	Zglob,RH M38x1.5 Ball joint, RH Kugelgelenk, RH	40	K30	120	
<b>81 95301 6219</b> 81 95301 6225 81 95301 6226 81 95301 6267 81 95301 6291	<b>4109.20.00</b>	Zglob,RH M26x1.5* Ball joint, RH Kugelgelenk, RH	35	K30	80	
<b>81 95301 6219</b> 81 95301 6225 81 95301 6226	<b>6425.20.00</b>	Zglob,RH M26x1.5* Ball joint, RH Kugelgelenk, RH	40	K30	80	
<b>81 96301 6232</b>	<b>4163.20.00</b>	Zglob, RH M30x1,5 * Ball joint, RH Kugelgelenk, RH	50	K38	86	
<b>81 95301 6297</b>	<b>3581.20.00</b>	Zglob,RH M38x1.5 Ball joint, RH Kugelgelenk, RH	50	K38	135	

Originalni broj Cross-Ref.-No. Original Nr.	Br. FAD No. No. Nr.	Naziv Designation Bezeichnung	Kugla Ball Ø Größe	Konus Taper Konus	Dužina Length Länge	Skica Figure Bild
<b>81 95302 0039</b>	<b>5535.96.00</b>	Izmenjivi podsklop Repair kit Reparatur satz	78.5	Ø16.5 >34<		
<b>82 46610 6049</b>	<b>6322.00.00</b>	Poprečna spona Tie rod Spurstange  Izmenjivi delovi Parts list Stuckliste 6321.10.00 4563.20.00	40	K30	2060  RØ50	
<b>82 46610 6079</b> 82 46610 6143 82 46610 6153	<b>4168.00.00</b>	Spona upravljača Drag link Lenkstange  Izmenjivi delovi Parts list Stuckliste 4563.20.00	40	K30	1010 RØ50	
<b>82 95301 0011</b>	<b>7474.20.00</b>	Zglob,RH M24x1.5* Ball joint, RH Kugelgelenk, RH	40	K30	95	
<b>85 43220 6001</b>	<b>6695.00.00</b>	Vodica mosta Torque rod Achsstrebe  Izmenjivi delovi Parts list Stuckliste 4569.96.00	62	Ø19 >24< <130>	596  RØ50	
<b>85 43220 6002</b>	<b>4569.96.00</b>	Izmenjivi podsklop Repair kit Reparatur satz	62	Ø19 >24<	<130>	

Originalni broj Cross-Ref.-No. Original Nr.	Br. FAD No. Nr.	Naziv Designation Bezeichnung	Kugla Ball Ø Größe	Konus Taper Konus	Dužina Length Länge	Skica Figure Bild
<b>85 43220 6004</b>	<b>6696.00.00</b>	Vodica mosta Torque rod Achsstrebe  Izmenjivi delovi Parts list Stuckliste 5383.96.00	55	Ø17 >24< <100>	660  RØ40	
<b>85 43270 6001</b>	<b>4151.00.00</b>	V Vodica mosta Triangular torque rod Dreieckslenker  Izmenjivi delovi Parts list 4151.96.00 4483.96.00	70/ 62.5	Ø25/2 3 >24< <152> <130>	627  RØ50	
<b>85 46610 6012</b> 85 46610 6112 85 46610 6142 85 46610 6212	<b>4146.00.00</b>	Spona upravljača Drag link Lenkstange  Izmenjivi delovi Parts list Stuckliste 5741.20.00	35	K26	860  RØ40	
<b>85 46610 6018</b> 85 46610 6118 85 46610 6152 85 46610 6218	<b>4149.00.00</b>	Spona upravljača Drag link Lenkstange  Izmenjivi delovi Parts list Stuckliste 5743.20.00	40	K30	980  RØ40	
<b>85 46610 6021</b> 85 46610 6121 85 46610 6140	<b>4117.00.00</b>	Spona upravljača Drag link Lenkstange  Izmenjivi delovi Parts list Stuckliste 5746.20.00	30	K22	840  RØ40	



Originalni broj Cross-Ref.-No. Original Nr.	Br. FAD No. Nr.	Naziv Designation Bezeichnung	Kugla Ball Ø Größe	Konus Taper Konus	Dužina Length Länge	Skica Figure Bild
<b>85 46610 6056</b>	<b>6324.00.00</b>	Spona upravljača Drag link Lenkstange Izmenjivi delovi Parts list Stuckliste 5741.20.00	35	K26	926 RØ40	
<b>85 46610 6107</b> 85 46610 6143	<b>4143.00.00</b>	Spona upravljača Drag link Lenkstange Izmenjivi delovi Parts list Stuckliste 5743.20.00	40/35	K30/ 26	860 RØ40	
<b>85 46610 6108</b> 85 46610 6144 85 46610 6208	<b>4138.00.00</b>	Spona upravljača Drag link Lenkstange Izmenjivi delovi Parts list Stuckliste 5743.20.00	40	K30	896 RØ40	
<b>85 46610 6141</b> 85 46610 6205 85 46610 6231	<b>4141.00.00</b>	Spona upravljača Drag link Lenkstange Izmenjivi delovi Parts list Stuckliste 5741.20.00	35	K26	787 RØ40	
<b>85 46610 6160</b> 85 46610 6246	<b>6680.00.00</b>	Spona upravljača Drag link Lenkstange Izmenjivi delovi Parts list Stuckliste 5746.20.00	30	K22	864 RØ40	
<b>85 46610 6162</b>	<b>4156.00.00</b>	Spona upravljača Drag link Lenkstange Izmenjivi delovi Parts list Stuckliste 5746.20.00	30	K22	820 RØ40	

Originalni broj Cross-Ref.-No. Original Nr.	Br. FAD No. No. Nr.	Naziv Designation Bezeichnung	Kugla Ball Ø Größe	Konus Taper Konus	Dužina Length Länge	Skica Figure Bild
<b>85 46610 6163</b>	<b>4157.00.00</b>	Spona upravljača Drag link Lenkstange  Izmenjivi delovi Parts list Stuckliste 5743.20.00	40/35	K30/ 26	860 RØ40	
<b>85 46610 6244</b>	<b>4158.00.00</b>	Spona upravljača Drag link Lenkstange  Izmenjivi delovi Parts list Stuckliste 7414.20.00	30	K20	853 RØ32	
<b>85 46610 6247</b>	<b>4159.00.00</b>	Spona upravljača Drag link Lenkstange  Izmenjivi delovi Parts list Stuckliste 5746.20.00	30	K22	853 RØ40	

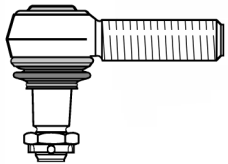
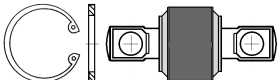
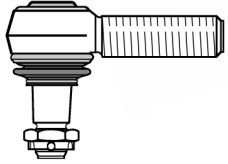
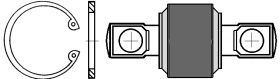
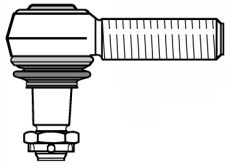
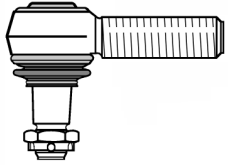
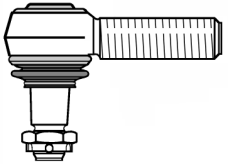
Originalni broj Cross-Ref.-No. Original Nr.	Br. FAD No. Nr.	Naziv Designation Bezeichnung	Kugla Ball Ø Größe	Konus Taper Konus	Dužina Length Länge	Skica Figure Bild
<b>000 268 01 81</b> 000 268 48 89 000 268 52 89	<b>3590.20.00</b>	Zglob,RH M14x1.5 Ball joint, RH Kugelgelenk, RH	22	K12	85	
<b>000 330 00 75</b>	<b>3310.96.00</b>	Izmenljivi podsklop Repair kit Reparatur satz	70	Ø16 >30<	<130>	
<b>000 330 01 48</b> 001 330 88 35 302 330 00 35 302 330 01 35 302 330 02 35 302 330 03 35 350 330 71 35	<b>5741.10.00</b>	Zglob,LH M30x1.5 Ball joint, LH Kugelgelenk, LH	35	K26	115	
<b>000 330 02 07</b>	<b>5117.96.00</b>	Izmenljivi podsklop Repair kit Reparatur satz	62	Ø19 >24<	<130>	
<b>000 330 02 35</b> 000 330 07 35 000 330 68 35 000 330 86 35 000 330 88 35	<b>5805.10.00</b>	Zglob,LH M24x1.5 Ball joint, LH Kugelgelenk, LH	30	K20	95	
<b>000 330 02 48</b> 000 330 32 35 000 338 34 10 000 460 83 48 000 463 34 29 001 330 01 35 001 330 02 35 001 460 44 48	<b>5741.20.00</b>	Zglob,RH M30x1.5 Ball joint, RH Kugelgelenk, RH	35	K26	115	
<b>000 330 03 35</b> 000 330 06 35 000 330 85 35 000 330 87 35 000 463 32 29	<b>5805.10.00</b>	Zglob,RH M24x1.5 Ball joint, RH Kugelgelenk, RH	30	K20	95	

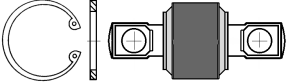
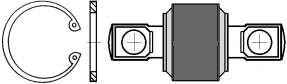
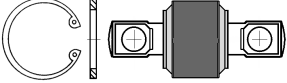
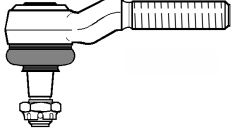
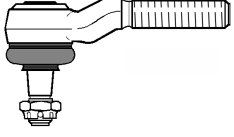
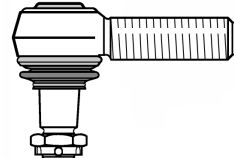
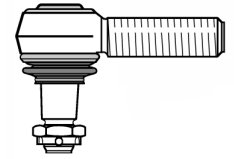
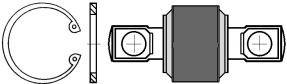
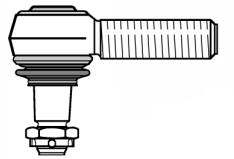
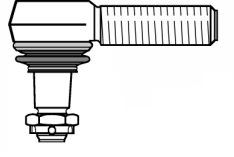
Originalni broj Cross-Ref.-No. Original Nr.	Br. FAD No. Nr.	Naziv Designation Bezeichnung	Kugla Ball Ø Größe	Konus Taper Konus	Dužina Length Länge	Skica Figure Bild
<b>000 330 05 11</b> 000 330 22 11	<b>5128.96.00</b>	Izmenljivi podsklop Repair kit Reparatur satz	55	Ø19 >24<	<130>	
<b>000 330 07 07</b>	<b>5323.96.00</b>	Izmenljivi podsklop Repair kit Reparatur satz	62	Ø17 >24<	<115>	
<b>000 330 07 07</b>	<b>5521.96.00</b>	Izmenljivi podsklop Repair kit Reparatur satz	62	Ø19 >24<	<115>	
<b>000 330 08 35</b>	<b>5797.10.00</b>	Zglob,LH M22x1.5 Ball joint, LH Kugelgelenk, LH	25	K18	160	
<b>000 330 09 35</b>	<b>5797.20.00</b>	Zglob,RH M22x1.5 Ball joint, RH Kugelgelenk, RH	25	K18	160	
<b>000 330 11 35</b>	<b>5733.10.00</b>	Zglob,LH M24x1.5 Ball joint, LH Kugelgelenk, LH	25	K18	95	
<b>000 330 12 35</b> 000 330 13 35 000 330 98 35	<b>4746.20.00</b>	Zglob,RH M24x1.5 Ball joint, RH Kugelgelenk, RH	30	K22	105	
<b>000 330 14 11</b>	<b>3935.96.00</b>	Izmenljivi podsklop Repair kit Reparatur satz	55	Ø17 >20<	<100>	
<b>000 330 14 35</b>	<b>3713.20.00</b>	Zglob,RH M28x1.5 Ball joint, RH Kugelgelenk, RH	30	K22	105	
<b>000 330 14 35</b> 000 330 15 35 000 330 93 35 000 330 95 35	<b>5746.20.00</b>	Zglob,RH M28x1.5 Ball joint, RH Kugelgelenk, RH	30	K22	105	

Originalni broj Cross-Ref.-No. Original Nr.	FAD Br. No. Nr.	Naziv Designation Bezeichnung	Kugla Ball Ø Größe	Kon us Tap er Kon us	Dužina Length Länge	Skica Figure Bild
<b>000 330 19 35</b> 000 330 29 35 000 330 41 35 000 330 78 35 000 338 50 29 001 330 22 35 001 330 27 35	<b>5848.10.00</b>	Zglob,LH M35x1.5 * Ball joint, LH Kugelgelenk, LH	35	K26	150	
<b>000 330 20 11</b>	<b>4569.96.00</b>	Izmenljivi podsklop Repair kit Reparatur satz	62	Ø1 9 >24 <	<130>	
<b>000 330 26 35</b> 000 330 69 35 001 330 08 35 001 330 10 35	<b>3692.10.00</b>	Zglob,LH M24x1.5 Ball joint, LH Kugelgelenk, LH	25	K18	160	
<b>000 330 27 35</b> 000 330 70 35 001 330 09 35 001 330 07 35	<b>3692.20.00</b>	Zglob,RH M24x1.5 Ball joint, RH Kugelgelenk, RH	25	K18	160	
<b>000 330 31 35</b> 000 330 81 35 001 330 03 35 001 330 04 35	<b>5748.20.00</b>	Zglob,RH M30x1.5 Ball joint, RH Kugelgelenk, RH	35	K22	115	
<b>000 330 33 35</b>	<b>3713.10.00</b>	Zglob,LH M28x1.5 Ball joint, LH Kugelgelenk, LH	30	K22	105	
<b>000 330 33 35</b> 000 330 72 35 000 330 94 35 000 330 96 35	<b>5746.10.00</b>	Zglob,LH M28x1.5 Ball joint, LH Kugelgelenk, LH	30	K22	105	
<b>000 330 40 35</b> 000 330 49 29 000 330 77 35 001 330 21 35 001 330 26 35	<b>5848.20.00</b>	Zglob,RH M35x1.5 * Ball joint, RH Kugelgelenk, RH	35	K26	150	



Originalni broj Cross-Ref.-No. Original Nr.	Br. FAD No. Nr.	Naziv Designation Bezeichnung	Kugla Ball Ø Größe	Konus Taper Konus	Dužina Length Länge	Skica Figure Bild
<b>000 330 50 35</b> 000 460 21 48 000 460 41 48 000 460 45 48 000 460 85 48 310 330 08 35 310 330 13 35 310 330 04 35	<b>5774.20.00</b>	Zglob,RH M22x1.5 Ball joint, RH Kugelgelenk, RH	30	K18	95	
<b>000 330 56 35</b> 000 338 18 10 000 460 43 48 000 460 56 48 310 330 06 35 310 330 10 35 310 330 12 35	<b>7414.20.00</b>	Zglob,RH M24x1.5 Ball joint, RH Kugelgelenk, RH	30	K20	105	
<b>000 338 08 10</b> 000 338 20 10 000 338 50 10 000 338 53 10	<b>1701.10.00</b>	Zglob,LH M14x1.5 Ball joint, LH Kugelgelenk, LH	22	K14	90	
<b>000 338 16 10</b> 001 330 10 35 001 330 12 35 001 330 14 35	<b>5733.20.00</b>	Zglob,RH M24x1.5 Ball joint, RH Kugelgelenk, RH	25	K18	95	
<b>000 338 42 10</b> 000 338 44 10 000 338 61 10	<b>1715.20.00</b>	Zglob,RH M12x1.5 Ball joint, RH Kugelgelenk, RH	22	K12	85	
<b>000 338 43 10</b> 000 338 45 10 000 338 60 10 000 338 62 10	<b>1715.10.00</b>	Zglob,LH M12x1.5 Ball joint, LH Kugelgelenk, LH	22	K12	85	
<b>000 338 51 10</b>	<b>1702.20.00</b>	Zglob,RH M14x1.5 Ball joint, RH Kugelgelenk, RH	22	K14	80	
<b>000 338 54 10</b>	<b>1701.20.00</b>	Zglob,RH M14x1.5 Ball joint, RH Kugelgelenk, RH	22	K14	90	

Originalni broj Cross-Ref.-No. Original Nr.	Br. FAD No. No.	Naziv Designation Bezeichnung	Kugla Ball Ø Größe	Konus Taper Konus	Dužina Length Länge	Skica Figure Bild
<b>000 350 01 05</b>	<b>3500.90.00</b>	Izmenljivi podsklop Repair kit Reparatur satz	80	K40		
<b>000 350 01 13</b>	<b>3769.96.00</b>	Izmenljivi podsklop Repair kit Reparatur satz	90	Ø21 >24<	<152>	
<b>000 350 02 05</b>	<b>3956.90.00</b>	Izmenljivi podsklop Repair kit Reparatur satz	65	K38		
<b>000 350 02 13</b> 000 350 03 05 000 350 05 05 000 586 14 33	<b>3755.90.00</b>	Izmenljivi podsklop Repair kit Reparatur satz	65	Ø21 >24<	<152>	
<b>000 350 04 13</b> 000 586 12 35	<b>3765.96.00</b>	Izmenljivi podsklop Repair kit Reparatur satz	78.5	Ø21 >24<	<152>	
<b>000 350 05 06</b>	<b>5170.96.00</b>	Izmenljivi podsklop Repair kit Reparatur satz	70	Ø19 >30<	<130>	
<b>000 350 06 13</b> 000 586 11 35	<b>3744.96.00</b>	Izmenljivi podsklop Repair kit Reparatur satz	70	Ø21 >24<	<152>	
<b>000 350 10 05</b>	<b>6021.96.00</b>	Izmenljivi podsklop Repair kit Reparatur satz	55	Ø15 >24<	<115>	

Originalni broj Cross-Ref.-No. Original Nr.	Br. FAD No. Nr.	Naziv Designation Bezeichnung	Kugla Ball Ø Größe	Konus Taper Konus	Dužina Length Länge	Skica Figure Bild
000 350 10 05	5847.96.00	Izmenljivi podsklop Repair kit Reparatur satz	70	K45		
000 350 11 05	5705.96.00	Izmenljivi podsklop Repair kit Reparatur satz	95	K45		
000 350 14 05	3950.90.00	Izmenljivi podsklop Repair kit Reparatur satz	65	Ø21/ Ø26	<152>	
000 350 20 05	5367.96.00	Izmenljivi podsklop Repair kit Reparatur satz	55	Ø23 >24<	<130>	
000 350 21 05	3936.96.00	Izmenljivi podsklop Repair kit Reparatur satz	62.5	Ø25 >24<	<152>	
000 350 22 05	4482.96.00	Izmenljivi podsklop Repair kit Reparatur satz	62.5	Ø25 >24<	<130>	
000 350 23 05	4483.96.00	Izmenljivi podsklop Repair kit Reparatur satz	70	Ø25 >24<	<152>	
000 350 24 05	4484.96.00	Izmenljivi podsklop Repair kit Reparatur satz	83	Ø25 >24<	<152>	
000 350 25 05	6023.96.00	Izmenljivi podsklop Repair kit Reparatur satz	62	Ø25 >24<	<130>	



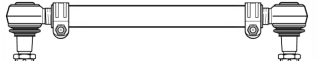
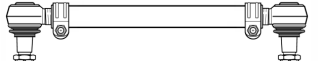

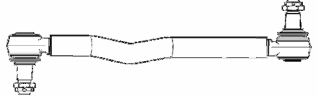
Originalni broj Cross-Ref.-No. Original Nr.	Br. FAD No. Nr.	Naziv Designation Bezeichnung	Kugla Ball Ø Größe	Konus Taper Konus	Dužina Length Länge	Skica Figure Bild
<b>000 350 28 05</b>	<b>4492.96.00</b>	Izmenljivi podsklop Repair kit Reparatur satz	70	Ø25 >24<	<130>	
<b>000 350 29 05</b>	<b>4490.96.00</b>	Izmenljivi podsklop Repair kit Reparatur satz	90	Ø25 >24<	<152>	
<b>000 360 098 524</b> 000 390 098 524 941 330 00 11 SA 508 316/01	<b>3302.00.00</b>	Vođica mosta Torque rod Achsstrebe Izmenljivi delovi Parts list Stuckliste 3302.90.00 3935.96.00	55	Ø17/ Ø25	754 RØ60	
<b>000 460 01 48</b> 000 460 26 48 000 460 27 48	<b>5742.20.00</b>	Zglob,RH M30x1.5 Ball joint, RH Kugelgelenk, RH	40	K26	120	
<b>000 460 03 48</b> 000 460 28 48 000 460 29 48 001 460 22 48	<b>5743.20.00</b>	Zglob,RH M30x1.5 Ball joint, RH Kugelgelenk, RH	40	K30	120	
<b>000 460 06 48</b> 000 460 12 48 000 460 34 48 000 460 35 48 001 460 14 48	<b>5743.10.00</b>	Zglob,LH M30x1.5 Ball joint, LH Kugelgelenk, LH	40	K30	120	
<b>000 460 17 48</b>	<b>3581.20.00</b>	Zglob,RH M38x1.5 Ball joint, RH Kugelgelenk, RH	50	K38	135	

Originalni broj Cross-Ref.-No. Original Nr.	Br. FAD No. Nr.	Naziv Designation Bezeichnung	Kugla Ball Ø Größe	Konus Taper Konus	Dužina Length Länge	Skica Figure Bild
<b>000 460 24 05</b> 000 460 25 05	<b>4582.00.00</b>	Spona upravljača Drag link Lenkstange  Izmenljivi delovi Parts list Stuckliste 5743.20.00	40	K30	820 RØ40	
<b>000 460 28 05</b> 000 460 36 05 000 460 51 05 625 460 43 05 625 460 77 05	<b>5905.00.00</b>	Spona upravljača Drag link Lenkstange  Izmenljivi delovi Parts list Stuckliste 5855.10.00 5855.20.00	40	K32	600 RØ40	
<b>000 460 39 05</b> 625 460 38 05 625 460 52 05 625 460 79 05	<b>5906.00.00</b>	Spona upravljača Drag link Lenkstange  Izmenljivi delovi Parts list Stuckliste 5855.10.00 5855.20.00	40	K32	520 RØ40	
<b>000 460 41 05</b> 000 460 55 05 625 460 42 05 625 460 78 05	<b>6887.00.00</b>	Spona upravljača Drag link Lenkstange	40	K32	1242 RØ52	
<b>000 460 43 05</b> 625 460 48 05	<b>4554.00.00</b>	Spona upravljača Drag link Lenkstange	40	K32	680 RØ42	



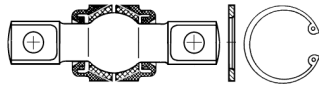
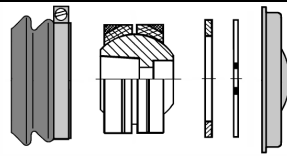
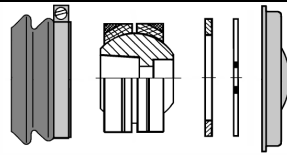
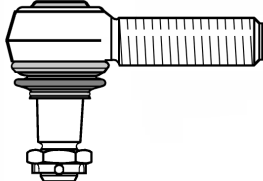
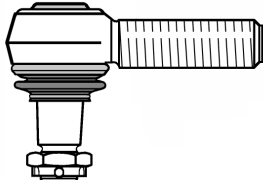

Originalni broj Cross-Ref.-No. Original Nr.	Br. FAD No. No.	Naziv Designation Bezeichnung	Kugla Ball Ø Größe	Konus Taper Konus	Dužina Length Länge	Skica Figure Bild
<b>000 460 45 05</b> 002 460 83 05 625 460 80 05	<b>4556.00.00</b>	Spona upravljača Drag link Lenkstange  Izmenljivi delovi Parts list Stuckliste 5855.20.00	40	K32	870 RØ50	
<b>000 460 48 48</b> 001 460 06 48	<b>4489.20.00</b>	Zglob,RH M30x1.5 Ball joint, RH Kugelgelenk, RH	40	K32	155	
<b>000 460 49 48</b>	<b>5904.20.00</b>	Zglob,RH M26x1.5 * Ball joint, RH Kugelgelenk, RH	40	K30	95	
<b>000 460 50 48</b>	<b>4575.20.00</b>	Zglob,RH M26x1.5 * Ball joint, RH Kugelgelenk, RH	40	K32	95	
<b>000 460 57 48</b> 000 460 60 48 000 460 68 48 000 460 70 48 000 460 75 48 001 460 11 48 001 460 17 48 001 460 24 48 001 460 76 48 001 330 18 35	<b>5855.20.00</b>	Zglob,RH M30x1.5 Ball joint, RH Kugelgelenk, RH	40	K32	120	
<b>000 460 58 48</b> 000 460 69 48 000 460 61 48 000 460 71 48 001 460 05 48 001 460 13 48	<b>5855.10.00</b>	Zglob,LH M30x1.5 Ball joint, LH Kugelgelenk, LH	40	K32	120	

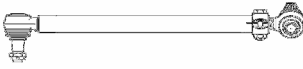
Originalni broj Cross-Ref.-No. Original Nr.	Br. FAD No. Nr.	Naziv Designation Bezeichnung	Kugla Ball Ø Größe	Konus Taper Konus	Dužina Length Länge	Skica Figure Bild
000 460 71 05 000 460 72 05 001 460 67 05	4529.00.00	Spona upravljača Drag link Lenkstange  Izmenljivi delovi Parts list Stuckliste 5743.20.00	40	K30	879 RØ42	
000 460 72 48 001 330 48 35 460 330 12 35	1074.20.00	Zglob,RH M20x1.5 Ball joint, RH Kugelgelenk, RH	30	K20	90	
000 460 77 48 001 460 21 48	5369.20.00	Zglob,RH M24x1.5 Ball joint, RH Kugelgelenk, RH	40	K30	120	
000 460 78 48 001 460 20 48	5369.10.00	Zglob,LH M24x1.5 Ball joint, LH Kugelgelenk, LH	40	K30	120	
000 460 84 48 001 460 07 48	4489.10.00	Zglob,LH M30x1.5 Ball joint, LH Kugelgelenk, LH	40	K32	155	
000 460 85 05 002 460 10 05 003 460 29 05	6924.00.00	Spona upravljača Drag link Lenkstange	40	K30	2069 RØ40	
000 460 92 05 000 460 93 05 001 460 69 05	4495.00.00	Spona upravljača Drag link Lenkstange  Izmenljivi delovi Parts list Stuckliste 5743.20.00	40	K30	873 RØ42	



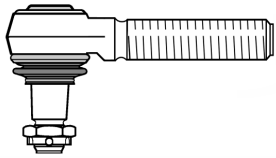

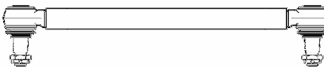
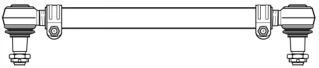
Originalni broj Cross-Ref.-No. Original Nr.	Br. FAD No. Nr.	Naziv Designation Bezeichnung	Kugla Ball Ø Größe	Konus Taper Konus	Dužina Length Länge	Skica Figure Bild
<b>000 460 95 05</b> 001 460 71 05	<b>4528.00.00</b>	Spona upravljača Drag link Lenkstange Izmenljivi delovi Parts list Stuckliste 5855.20.00	40	K32	904 RØ52	
<b>000 460 98 05</b> 000 460 99 05	<b>4531.00.00</b>	Spona upravljača Drag link Lenkstange Izmenljivi delovi Parts list Stuckliste 5743.20.00	40	K30	889 RØ50	
<b>000 463 23 29</b> 000 463 26 29	<b>5899.20.00</b>	Zglob,RH M22x1.5 * Ball joint, RH Kugelgelenk, RH	40	K26	90	
<b>000 463 24 29</b> 000 463 25 29	<b>5900.20.00</b>	Zglob,RH M22x1.5 Ball joint, RH Kugelgelenk, RH	35	K26	75	
<b>000 463 40 29</b> 000 463 41 29	<b>7523.20.00</b>	Zglob,RH M24x1.5 * Ball joint, RH Kugelgelenk, RH	35	K26	90	
<b>000 586 01 32</b>	<b>3757.90.00</b>	Izmenljivi podsklop Repair kit Reparatur satz	65	Ø19 >24<	<152>	
<b>000 586 06 32</b>	<b>3991.95.00</b>	Izmenljivi podsklop Repair kit Reparatur satz	65	K45		
<b>000 586 07 32</b>	<b>3757.95.00</b>	Izmenljivi podsklop Repair kit Reparatur satz	65	Ø19 >24<	<152>	

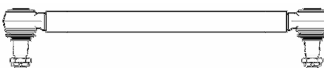
Originalni broj Cross-Ref.-No. Original Nr.	Br. FAD No. Nr.	Naziv Designation Bezeichnung	Kugla Ball Ø Größe	Konus Taper Konus	Dužina Length Länge	Skica Figure Bild
<b>000 586 09 32</b>	<b>5854.90.00</b>	Izmenljivi podsklop Repair kit Reparatur satz	65	Ø16 >30<	<130>	
<b>000 586 10 35</b>	<b>5846.90.00</b>	Izmenljivi podsklop Repair kit Reparatur satz	65	K38		
<b>000 586 19 33</b>	<b>3500.95.00</b>	Izmenljivi podsklop Repair kit Reparatur satz	80	K40		
<b>001 330 18 35</b>	<b>5856.20.00</b>	Zglob,RH M38x1.5 Ball joint, RH Kugelgelenk, RH	40	K30	120	
<b>001 330 99 35</b>	<b>4590.20.00</b>	Zglob,RH M38x1.5 Ball joint, RH Kugelgelenk, RH	40	K32	141	
<b>001 460 03 05</b> 001 460 04 05	<b>4533.00.00</b>	Spona upravljača Drag link Lenkstange  Izmenljivi delovi Parts list Stuckliste 5855.20.00	40	K32/ K30	840 RØ50	
<b>001 460 05 05</b> 001 460 06 05	<b>4545.00.00</b>	Spona upravljača Drag link Lenkstange  Izmenljivi delovi Parts list Stuckliste 5855.20.00	40	K32	870 RØ42	



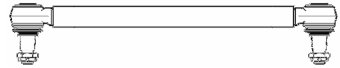
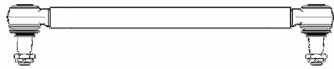
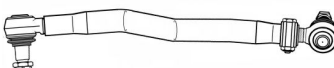

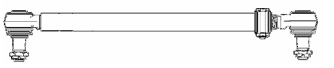

Originalni broj Cross-Ref.-No. Original Nr.	Br. FAD No. Nr.	Naziv Designation Bezeichnung	Kugla Ball Ø Größe	Konus Taper Konus	Dužina Length Länge	Skica Figure Bild
001 460 07 05 001 460 08 05 001 460 70 05	4519.00.00	Spona upravljača Drag link Lenkstange  Izmenljivi delovi Parts list Stuckliste 5743.20.00	40	K30	888 RØ40	
001 460 11 05 002 460 04 05	4568.00.00	Spona upravljača Drag link Lenkstange	40	K32	710 RØ42	
001 460 13 05 001 460 14 05 002 460 05 05	4551.00.00	Spona upravljača Drag link Lenkstange	40	K32	1095 RØ42	
001 460 15 05 001 460 73 05 375 460 16 05	4548.00.00	Spona upravljača Drag link Lenkstange  Izmenljivi delovi Parts list Stuckliste 5855.20.00 5855.10.00	40	K32	733 RØ40	
001 460 15 48 001 460 16 48	4558.20.00	Zglob,RH M26x1.5 * Ball joint, RH Kugelgelenk, RH	40	K32	75	
001 460 29 05 001 460 30 05	3973.00.00	Spona upravljača Drag link Lenkstange  Izmenljivi delovi Parts list Stuckliste 5855.20.00	40	K32	830 RØ52	





Originalni broj Cross-Ref.-No. Original Nr.	Br. FAD No. Nr.	Naziv Designation Bezeichnung	Kugla Ball Ø Größe	Konus Taper Konus	Dužina Length Länge	Skica Figure Bild
001 460 42 48 001 460 50 48 001 460 85 48	6881.20.00	Zglob,RH M28x1.5 Ball joint, RH Kugelgelenk, RH	35	K28.6	141	
001 460 49 05 001 460 74 05	4574.00.00	Spona upravljača Drag link Lenkstange  Izmenljivi delovi Parts list Stuckliste 5855.20.00	40	K32	893 RØ42	
001 460 62 05 002 460 12 05	4504.00.00	Spona upravljača Drag link Lenkstange	40	K30	1863 RØ42	
001 460 63 05 001 460 85 05	4510.00.00	Spona upravljača Drag link Lenkstange  Izmenljivi delovi Parts list Stuckliste 5743.10.00 5743.20.00	40	K30	758 RØ40	
001 460 79 05 003 460 39 05	6916.00.00	Spona upravljača Drag link Lenkstange  Izmenljivi delovi Parts list Stuckliste 5743.20.00	40	K30	869 RØ36	
001 460 86 05 001 460 87 05	4515.00.00	Spona upravljača Drag link Lenkstange	40	K30	954 RØ42	







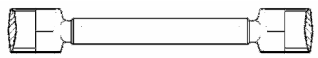
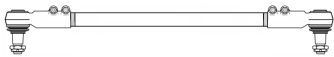

Originalni broj Cross-Ref.-No. Original Nr.	Br. FAD No. Nr.	Naziv Designation Bezeichnung	Kugla Ball Ø Größe	Konus Taper Konus	Dužina Length Länge	Skica Figure Bild
<b>001 460 90 05</b> 001 460 91 05	<b>4599.00.00</b>	Spona upravljača Drag link Lenkstange	40	K30	1559 RØ42	
<b>001 460 89 05</b> <b>002 460 13 05</b>	<b>4505.00.00</b>	Spona upravljača Drag link Lenkstange	40	K30	1255 RØ42	
<b>001 460 96 05</b>	<b>5889.00.00</b>	Spona upravljača Drag link Lenkstange  Izmenljivi delovi Parts list Stuckliste 5743.20.00	40	K30	860 RØ50	
<b>001 460 98 05</b> 001 460 99 05 002 460 64 05	<b>4563.00.00</b>	Spona upravljača Drag link Lenkstange  Izmenljivi delovi Parts list Stuckliste 5743.20.00	40	K30	866 RØ40	
<b>002 460 43 05</b> 002 460 44 05	<b>6881.00.00</b>	Spona upravljača Drag link Lenkstange Izmenljivi delovi Parts list Stuckliste 6881.20.00	35	K28.6	879 RØ36	
<b>002 460 45 05</b> 002 460 46 05	<b>6882.00.00</b>	Spona upravljača Drag link Lenkstange  Izmenljivi delovi Parts list Stuckliste 6881.20.00	35	K28.6	895 RØ36	

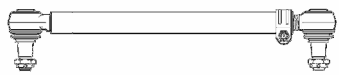
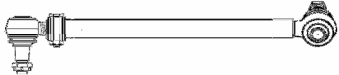
Originalni broj Cross-Ref.-No. Original Nr.	Br. FAD No. Nr.	Naziv Designation Bezeichnung	Kugla Ball Ø Größe	Konus Taper Konus	Dužina Length Länge	Skica Figure Bild
<b>002 460 47 05</b> 002 460 48 05	<b>4527.00.00</b>	Spona upravljača Drag link Lenkstange Izmenljivi delovi Parts list Stuckliste 5596.20.00	35	K28.6	876 RØ40	
<b>002 460 49 05</b> 002 460 50 05	<b>4539.00.00</b>	Spona upravljača Drag link Lenkstange Izmenljivi delovi Parts list Stuckliste 5596.20.00	35	K28.6	895 RØ40	
<b>002 460 51 05</b> 002 460 52 05	<b>4549.00.00</b>	Spona upravljača Drag link Lenkstange Izmenljivi delovi Parts list Stuckliste 5855.20.00	40	K32/30	885 RØ40	
<b>002 460 61 05</b> 002 460 62 05 003 460 42 05	<b>4584.00.00</b>	Spona upravljača Drag link Lenkstange  Izmenljivi delovi Parts list Stuckliste 5855.20.00	40	K32	893 RØ40	
<b>002 460 63 05</b>	<b>4541.00.00</b>	Spona upravljača Drag link Lenkstange Izmenljivi delovi Parts list Stuckliste 5743.20.00	40	K30	865 RØ40	
<b>002 460 88 05</b> 001 460 89 05	<b>4597.00.00</b>	Spona upravljača Drag link Lenkstange Izmenljivi delovi Parts list Stuckliste 5855.10.00 5855.20.00	40	K32	716 RØ40	

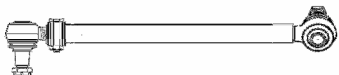
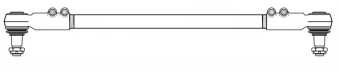
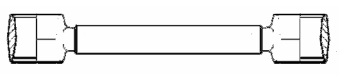
Originalni broj Cross-Ref.-No. Original Nr.	Br. FAD No. Nr.	Naziv Designation Bezeichnung	Kugla Ball Ø Größe	Konus Taper Konus	Dužina Length Länge	Skica Figure Bild
<b>002 460 96 05</b> 002 460 97 05	<b>4525.00.00</b>	Spona upravljača Drag link Lenkstange  Izmenljivi delovi Parts list Stuckliste 5596.20.00	35	K28.6	858 RØ40	
<b>080 460 67 05</b>	<b>4516.00.00</b>	Spona upravljača Drag link Lenkstange  Izmenljivi delovi Parts list Stuckliste 5743.10.00 5743.20.00	40	K30	502 RØ40	
<b>300 460 02 05</b> 300 460 03 05 301 460 00 05 301 460 01 05	<b>5875.00.00</b>	Spona upravljača Drag link Lenkstange  Izmenljivi delovi Parts list Stuckliste 5741.20.00	35	K26	658 RØ40	
<b>300 460 04 05</b> 300 460 05 05 301 460 05 05	<b>5835.00.00</b>	Spona upravljača Drag link Lenkstange  Izmenljivi delovi Parts list Stuckliste 5741.20.00	35	K26	1146 RØ40	
<b>300 460 06 05</b> 300 460 07 05 305 460 03 05	<b>5283.00.00</b>	Spona upravljača Drag link Lenkstange  Izmenljivi delovi Parts list Stuckliste 5741.20.00	35	K26	975 RØ36	
<b>301 330 00 11</b> 600 330 00 11	<b>3605.38.00</b>	Vodica mosta Torque rod Achsstrebe	83		880 RØ56	

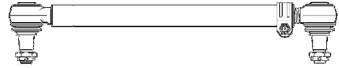
Originalni broj Cross-Ref.-No. Original Nr.	Br. FAD No. No.	Naziv Designation Bezeichnung	Kugla Ball Ø Größe	Konus Taper Konus	Dužina Length Länge	Skica Figure Bild
<b>302 330 01 03</b> 302 330 04 03 302 330 07 03	<b>3734.00.00</b>	Poprečna spona Tie rod Spurstange Izmenljivi delovi Parts list Stuckliste 5848.10.00 5848.20.00	35	K26	1678	
<b>302 330 03 03</b> 302 330 06 03 302 330 18 03	<b>3735.00.00</b>	Poprečna spona Tie rod Spurstange Izmenljivi delovi Parts list Stuckliste 5741.20.00	35	K26	1577 RØ40	
<b>302 330 03 11</b>	<b>5786.38.00</b>	Vođica mosta Torque rod Achsstrebe	83		768 RØ56	
<b>302 330 09 03</b> 302 330 13 03 302 330 15 03 302 330 17 03	<b>5725.00.00</b>	Poprečna spona Tie rod Spurstange Izmenljivi delovi Parts list Stuckliste 5848.10.00 5848.20.00	35	K26	1642 RØ40	
<b>302 330 09 03</b> 302 330 13 03 302 330 15 03 302 330 17 03	<b>5837.00.00</b>	Poprečna spona Tie rod Spurstange Izmenljivi delovi Parts list Stuckliste 5848.10.00 5848.20.00	35	K26	1642 RØ40	
<b>302 330 11 03</b> 302 330 14 03 302 330 16 03	<b>5862.00.00</b>	Poprečna spona Tie rod Spurstange Izmenljivi delovi Parts list Stuckliste 5848.10.00 5848.20.00	35	K26	1624 RØ46	

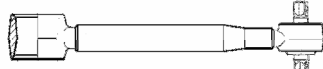

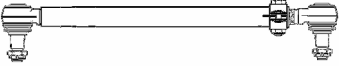
Originalni broj Cross-Ref.-No. Original Nr.	Br. FAD No. Nr.	Naziv Designation Bezeichnung	Kugla Ball Ø Größe	Konus Taper Konus	Dužina Length Länge	Skica Figure Bild
<b>302 460 05 05</b> 302 460 06 05 302 460 39 05 302 460 40 05 373 460 06 05 373 460 09 05	<b>5728.00.00</b>	Spona upravljača Drag link Lenkstange Izmenljivi delovi Parts list Stuckliste 5741.20.00	35	K26	687 RØ36	
<b>302 460 14 05</b> 302 460 20 05	<b>5794.00.00</b>	Spona upravljača Drag link Lenkstange Izmenljivi delovi Parts list Stuckliste 5741.20.00	35	K26	1340 RØ40	
<b>302 460 16 05</b> 302 460 18 05 302 460 24 05 302 460 37 05 302 460 38 05 373 460 08 05	<b>5721.00.00</b>	Spona upravljača Drag link Lenkstange Izmenljivi delovi Parts list Stuckliste 5741.20.00	35	K26	968 RØ40	
<b>302 460 33 05</b> 302 460 34 05	<b>5727.00.00</b>	Spona upravljača Drag link Lenkstange Izmenljivi delovi Parts list Stuckliste 5741.20.00	35	K26	987 RØ40	
<b>305 330 04 03</b> 305 330 08 03 305 330 10 03 305 330 11 03	<b>5282.00.00</b>	Poprečna spona Tie rod Spurstange  Izmenljivi delovi Parts list Stuckliste 5848.10.00 5848.20.00	35	K26	1713 RØ40	
<b>305 330 06 11</b>	<b>5785.38.00</b>	Vođica mosta Torque rod Achsstrebe	83		689 RØ56	

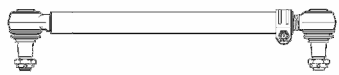
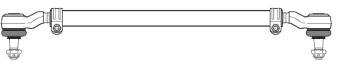
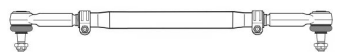
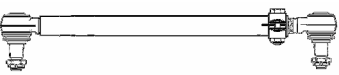



Originalni broj Cross-Ref.-No. Original Nr.	Br. FAD No. Nr.	Naziv Designation Bezeichnung	Kugla Ball Ø Größe	Konus Taper Konus	Dužina Length Länge	Skica Figure Bild
<b>305 460 04 05</b>	<b>5893.00.00</b>	Spona upravljača Drag link Lenkstange  Izmenljivi delovi Parts list Stuckliste 5741.20.00	35	K26	1043 RØ40	
<b>305 460 06 05</b> 357 460 12 05 357 460 13 05	<b>5887.00.00</b>	Spona upravljača Drag link Lenkstange  Izmenljivi delovi Parts list Stuckliste 5741.20.00	35	K26	1160 RØ40	
<b>307 330 01 11</b> 357 330 36 11	<b>3310.00.00</b>	Vođica mosta Torque rod Achsstrebe  Izmenljivi delovi Parts list Stuckliste 3310.96.00	70	Ø16 >30<	689 RØ56	
<b>307 330 01 11</b> 357 330 36 11	<b>5854.00.00</b>	Vođica mosta Torque rod Achsstrebe  Izmenljivi delovi Parts list Stuckliste 5854.90.00	65	Ø16 >30< <130>	689 RØ52	
<b>307 460 00 05</b> 307 460 05 05	<b>5843.00.00</b>	Spona upravljača Drag link  Lenkstange Izmenljivi delovi Parts list Stuckliste 5741.20.00	35	K26	1130 RØ40	

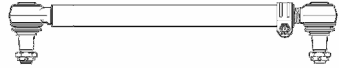
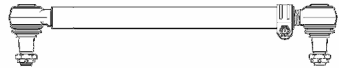

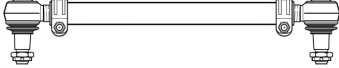
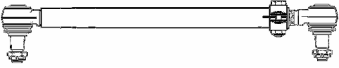

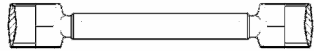
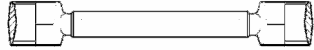
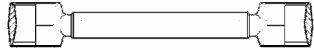
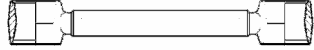
Originalni broj Cross-Ref.-No. Original Nr.	Br. FAD No. No.	Naziv Designation Bezeichnung	Kugla Ball Ø Größe	Konus Taper Konus	Dužina Length Länge	Skica Figure Bild
<b>307 460 04 05</b>	<b>5280.00.00</b>	Spona upravljača Drag link Lenkstange Izmenljivi delovi Parts list Stuckliste 5741.20.00	35	K26	1000 RØ40	
<b>309 330 06 03</b> 309 330 07 03 309 330 08 03 309 330 11 03	<b>5704.00.00</b>	Poprečna spona Tie rod Spurstange Izmenljivi delovi Parts list Stuckliste 5704.10.00 5704.20.00	30	K18	1476 RØ36	
<b>309 330 12 03</b> 309 330 13 03 309 330 14 03 309 330 16 03 309 330 17 03 309 330 18 03 309 330 19 03 309 330 20 03 309 330 21 03	<b>3692.00.00</b>	Poprečna spona Tie rod Spurstange  Izmenljivi delovi Parts list Stuckliste 3692.10.00 3692.20.00	25	K18	1476 RØ40	
<b>309 460 31 05</b> 309 460 03 05 309 460 04 05 309 460 05 05 309 460 08 05 309 460 09 05 309 460 10 05 309 460 11 05 309 460 12 05 309 460 13 05 309 460 14 05 309 460 20 05 309 460 22 05 309 460 23 05 309 460 24 05 309 460 25 05 309 460 26 05 309 460 29 05 309 460 29 05 601 460 00 05 601 460 01 05 601 460 02 05 601 460 03 05	<b>5775.00.00</b>	Spona upravljača Drag link Lenkstange  Izmenljivi delovi Parts list Stuckliste 5774.20.00	30	K18	486 RØ26	

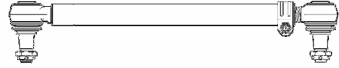

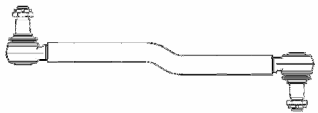

Originalni broj Cross-Ref.-No. Original Nr.	Br. FAD No. Nr.	Naziv Designation Bezeichnung	Kugla Ball Ø Größe	Konus Taper Konus	Dužina Length Länge	Skica Figure Bild
<b>310 330 00 35</b> 310 330 17 35 310 330 20 35 310 330 24 35	<b>5896.20.00</b>	Zglob,RH M24x1.5 Ball joint, RH Kugelgelenk, RH	30	K20	160	
<b>310 330 01 35</b> 310 330 16 35 310 330 21 35 310 330 25 35	<b>5896.10.00</b>	Zglob,LH M24x1.5 Ball joint, LH Kugelgelenk, LH	30	K20	160	
<b>310 330 02 35</b> 310 330 18 35 310 330 22 35 310 330 26 35	<b>5897.20.00</b>	Zglob,RH M24x1.5 Ball joint, RH Kugelgelenk, RH	30	K20	190	
<b>310 330 03 35</b> 310 330 19 35 310 330 23 35 310 330 27 35	<b>5897.10.00</b>	Zglob,LH M24x1.5 Ball joint, LH Kugelgelenk, LH	30	K20	190	
<b>310 330 06 03</b> 310 330 08 03 310 330 10 03 310 330 12 03	<b>5827.00.00</b>	Poprečna spona Tie rod Spurstange  Izmenljivi delovi Parts list 5896.10.00 5896.20.00	30	K20	1530  RØ30	
<b>310 330 07 03</b> 310 330 09 03 730.505 730.600	<b>5826.00.00</b>	Poprečna spona Tie rod Spurstange  Izmenljivi delovi Parts list Stuckliste 5896.10.00 5896.20.00	30	K20	1476  RØ30	

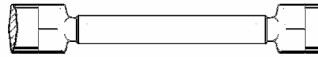
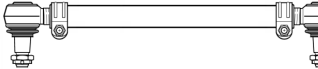



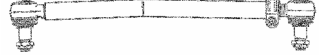

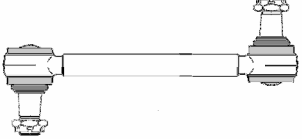
Originalni broj Cross-Ref.-No. Original Nr.	Br. FAD No. Nr.	Naziv Designation Bezeichnung	Kugla Ball Ø Größe	Konus Taper Konus	Dužina Length Länge	Skica Figure Bild
<b>313 460 01 05</b>	<b>3918.00.00</b>	Spona upravljača Drag link Lenkstange  Izmenljivi delovi Parts list Stuckliste 7414.20.00	30	K20	490 RØ30	
<b>314 330 03 03</b>	<b>5737.00.00</b>	Poprečna spona Tie rod Spurstange  Izmenljivi delovi Parts list Stuckliste 5737.10.00 5737.20.00	25	K18	1400 RØ36	
<b>314 460 03 05</b>	<b>5776.00.00</b>	Spona upravljača Drag link Lenkstange	30	K18	560 RØ30	
<b>314 460 08 05</b>	<b>5777.00.00</b>	Spona upravljača Drag link Lenkstange	30	K20	560 RØ30	
<b>316 330 02 03</b> <b>316 330 06 03</b> <b>316 330 07 03</b>	<b>5823.00.00</b>	Poprečna spona Tie rod Spurstange  Izmenljivi delovi Parts list Stuckliste 5805.10.00 5805.20.00	30	K20	1454 RØ36	
<b>316 460 06 05</b> <b>316 460 07 05</b> <b>316 460 08 05</b> <b>316 460 09 05</b>	<b>5720.00.00</b>	Spona upravljača Drag link Lenkstange  Izmenljivi delovi Parts list Stuckliste 5748.20.00	35	K22	530 RØ36	



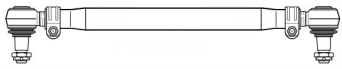

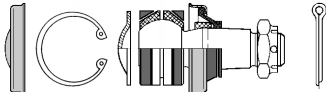
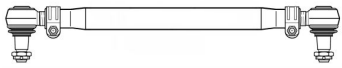

Originalni broj Cross-Ref.-No. Original Nr.	Br. FAD No. Nr.	Naziv Designation Bezeichnung	Kugla Ball Ø Größe	Konus Taper Konus	Dužina Length Länge	Skica Figure Bild
<b>317 330 02 11</b>	<b>3608.38.00</b>	Vodica mosta Torque rod Achsstrebe	83		820 RØ56	
<b>317 330 04 11</b> 357 330 42 11	<b>3609.38.00</b>	Vodica mosta Torque rod Achsstrebe	83		960 RØ56	
<b>317 350 06 06</b> 357 330 34 11	<b>3604.38.00</b>	Vodica mosta Torque rod Achsstrebe	83		585 RØ56	
<b>317 350 07 06</b> 600 330 01 11	<b>3602.38.00</b>	Vodica mosta Torque rod Achsstrebe	83		724 RØ56	
<b>317 460 57 05</b> 317 460 58 05	<b>5881.00.00</b>	Spona upravljača Drag link Lenkstange  Izmenljivi delovi Parts list Stuckliste 5743.20.00	40	K30	910 RØ40	
<b>317 460 61 05</b>	<b>5719.00.00</b>	Spona upravljača Drag link Lenkstange  Izmenljivi delovi Parts list Stuckliste 5743.20.00	40	K30	1065 RØ40	
<b>317 460 63 05</b>	<b>5724.00.00</b>	Spona upravljača Drag link Lenkstange  Izmenljivi delovi Parts list Stuckliste 5743.20.00	40	K30	1240 RØ40	

Originalni broj Cross-Ref.- No. Original Nr.	Br. FAD No. Nr.	Naziv Designation Bezeichnung	Kugla Ball Ø Größe	Konus Taper Konus	Dužina Length Länge	Skica Figure Bild
317 460 65 05 317 460 66 05 317 460 70 05 317 460 72 05	5718.00.00	Spona upravljača Drag link Lenkstange	40	K30	1009 RØ40	
317 460 67 05	5729.00.00	Spona upravljača Drag link Lenkstange	40	K30	1005 RØ40	
317 460 69 05 317 460 71 05	5882.00.00	Spona upravljača Drag link Lenkstange  Izmenljivi delovi Parts list Stuckliste 5743.20.00	40	K30	600 RØ40	
322 330 10 11 357 330 31 11	3601.38.00	Vodica mosta Torque rod Achsstrebe	83		775 RØ56	
327 330 01 03 327 330 03 03 327 330 04 03 352 330 02 03 358 330 07 03 358 330 08 03 358 330 00 03	5806.00.00	Poprečna spona Tie rod Spurstange  Izmenljivi delovi Parts list Stuckliste 4746.10.00 4746.20.00	30	K22	1648 RØ40	
327 460 00 05	5778.00.00	Spona upravljača Drag link Lenkstange	30	K22	673 RØ32	
327 460 06 05 327 460 16 05	5825.00.00	Spona upravljača Drag link Lenkstange Izmenljivi delovi Parts list Stuckliste 5748.20.00	30/35	K22	673 RØ36	

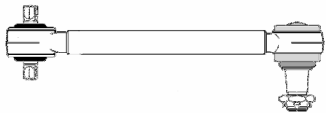
Originalni broj Cross-Ref.-No. Original Nr.	Br. FAD No. Nr.	Naziv Designation Bezeichnung	Kugla Ball Ø Größe	Konus Taper Konus	Dužina Length Länge	Skica Figure Bild
<b>335 460 05 05</b> 335 460 07 05 335 460 08 05	<b>3728.00.00</b>	Spona upravljača Drag link Lenkstange  Izmenljivi delovi Parts list Stuckliste 5742.20.00	40/35	K26	985 RØ40	
<b>343 320 16 32</b> 343 320 17 32 343 320 18 32	<b>3756.00.00</b>	Vođica mosta Torque rod Achsstrebe  Izmenljivi delovi Parts list Stuckliste 3991.90.00	65	K45	595 RØ50	
<b>343 320 16 32</b> 343 320 17 32 343 320 18 32	<b>3991.00.00</b>	Vođica mosta Torque rod Achsstrebe  Izmenljivi delovi Parts list Stuckliste 3991.90.00	65	K45	595 RØ50	
<b>343 320 16 32</b> 343 320 17 32 343 320 18 32	<b>3992.00.00</b>	Vođica mosta Torque rod Achsstrebe  Izmenljivi delovi Parts list Stuckliste 3991.90.00	65	K45	595 RØ50	
<b>343 330 01 03</b> 343 330 03 03 343 330 04 03	<b>5731.00.00</b>	Poprečna spona Tie rod Spurstange  Izmenljivi delovi Parts list Stuckliste 5743.10.00 5743.20.00	40	K30	1550 RØ50	

Originalni broj Cross-Ref.-No. Original Nr.	Br. FAD No. Nr.	Naziv Designation Bezeichnung	Kugla Ball Ø Größe	Konus Taper Konus	Dužina Length Länge	Skica Figure Bild
<b>343 330 01 03</b> 343 330 03 03 343 330 04 03	<b>5817.00.00</b>	Poprečna spona Tie rod Spurstange Izmenljivi delovi Parts list Stuckliste 5743.10.00 5743.20.00	40	K30	1550  RØ50	
<b>343 460 04 05</b> 343 460 08 05 343 460 10 05 343 460 12 05 343 460 14 05 343 460 15 05	<b>5820.00.00</b>	Spona upravljača Drag link Lenkstange Izmenljivi delovi Parts list Stuckliste 5743.20.00	40	K30	760  RØ40	
<b>343 586 00 32</b>	<b>3991.90.00</b>	Izmenljivi podsklop Repair kit Reparatur satz	65	K45		
<b>346 330 29 03</b> 346 330 43 03 346 330 44 03	<b>5807.00.00</b>	Poprečna spona Tie rod Spurstange Izmenljivi delovi Parts list Stuckliste 5741.10.00 5741.20.00	35	K26	1560  RØ50	
<b>346 330 45 03</b> 346 330 51 03	<b>3730.00.00</b>	Poprečna spona Tie rod Spurstange Izmenljivi delovi Parts list Stuckliste 5742.20.00	40	K26	1529  RØ50	
<b>346 330 49 03</b> 346 330 39 03	<b>5871.00.00</b>	Poprečna spona Tie rod Spurstange Izmenljivi delovi Parts list Stuckliste 5743.20.00	40	K30	1588  RØ58	





Originalni broj Cross-Ref.-No. Original Nr.	Br. FAD No. Nr.	Naziv Designation Bezeichnung	Kugla Ball Ø Größe	Konus Taper Konus	Dužina Length Länge	Skica Figure Bild
<b>346 330 50 03</b>	<b>3739.00.00</b>	Poprečna spona Tie rod Spurstange  Izmenljivi delovi Parts list Stuckliste 5741.10.00 5741.20.00	35	K26	1560  RØ50	
<b>352 330 17 03</b> 352 330 25 03 352 330 27 03	<b>5814.00.00</b>	Poprečna spona Tie rod Spurstange  Izmenljivi delovi Parts list Stuckliste 5746.20.00	30	K22	1648  RØ50	
<b>352 330 18 03</b> 352 330 26 03 352 330 28 03	<b>5818.00.00</b>	Poprečna spona Tie rod Spurstange  Izmenljivi delovi Parts list Stuckliste 5746.20.00	30	K22	1648  RØ50	
<b>352 330 19 03</b> 352 330 20 03 352 330 23 03 352 330 24 03	<b>5804.00.00</b>	Poprečna spona Tie rod Spurstange  Izmenljivi delovi Parts list Stuckliste 5746.20.00	30	K22	1626  RØ50	
<b>352 350 03 06</b>	<b>5840.00.00</b>	Vođica mosta Torque rod Achsstrebe Izmenljivi delovi Parts list Stuckliste 3757.90.00 3991.90.00	65	Ø19 >24< <152> K45	587  RØ50	

Originalni broj Cross-Ref.-No. Original Nr.	Br. FAD No. Nr.	Naziv Designation Bezeichnung	Kugla Ball Ø Größe	Konus Taper Konus	Dužina Length Länge	Skica Figure Bild
<b>352 350 04 06</b>	<b>3757.00.00</b>	Vođica mosta Torque rod Achsstrebe  Izmenljivi delovi Parts list Stuckliste 3757.90.00 3991.90.00	65	Ø19 >24< <152> K45	595  RØ50	
<b>352 460 10 05</b> 352 460 19 05 352 460 27 05 352 460 44 05 352 460 54 05	<b>3736.00.00</b>	Spona upravljača Drag link Lenkstange	30	K22	865  RØ40	
<b>352 460 21 05</b> 352 460 29 05 352 460 46 05 352 460 55 05	<b>5816.00.00</b>	Spona upravljača Drag link Lenkstange	30	K22	668  RØ40	
<b>352 460 22 05</b> 352 460 30 05 352 460 58 05	<b>5740.00.00</b>	Spona upravljača Drag link Lenkstange	30	K22	668  RØ40	
<b>352 460 23 05</b> 352 460 31 05 352 460 32 05 352 460 48 05 352 460 49 05 352 460 56 05	<b>3914.00.00</b>	Spona upravljača Drag link Lenkstange  Izmenljivi delovi Parts list Stuckliste 5748.20.00	35	K22	625  RØ36	
<b>352 460 28 05</b> 352 460 57 05	<b>3922.00.00</b>	Spona upravljača Drag link Lenkstange	30	K22	865  RØ40	

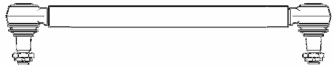
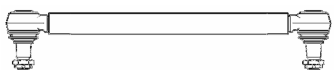
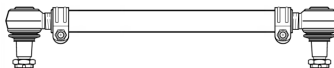
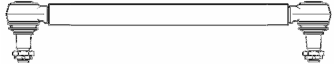
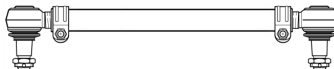
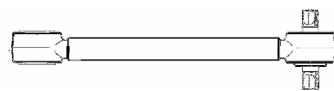
Originalni broj Cross-Ref.-No. Original Nr.	Br. FAD No. Nr.	Naziv Designation Bezeichnung	Kugla Ball Ø Größe	Konus Taper Konus	Dužina Length Länge	Skica Figure Bild
<b>352 460 33 05</b> 360 460 21 05 360 460 02 05 360 460 08 05	<b>5779.00.00</b>	Spona upravljača Drag link Lenkstange  Izmenljivi delovi Parts list Stuckliste 5746.20.00	30	K22	678  RØ42	
<b>352 460 35 05</b>	<b>3733.00.00</b>	Spona upravljača Drag link Lenkstange  Izmenljivi delovi Parts list Stuckliste 5748.20.00	30/35	K22	855  RØ40	
<b>352 460 37 05</b> 352 460 66 05 352 460 71 05	<b>3723.00.00</b>	Spona upravljača Drag link Lenkstange	35	K22	655  RØ36	
<b>353 330 03 03</b> 353 330 04 03 353 330 05 03 353 330 06 03	<b>5805.00.00</b>	Poprečna spona Tie rod Spurstange  Izmenljivi delovi Parts list Stuckliste 5805.10.00 5805.20.00	30	K20	1670  RØ36	
<b>355 460 09 05</b> 355 460 35 05 355 460 51 05	<b>3919.00.00</b>	Spona upravljača Drag link Lenkstange  Izmenljivi delovi Parts list Stuckliste 5742.20.00	35/40	K26	855  RØ40	

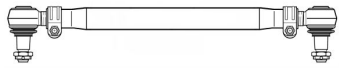

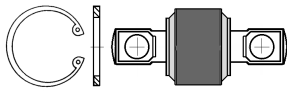



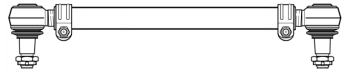
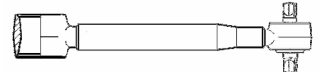
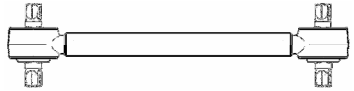
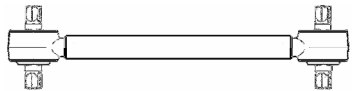
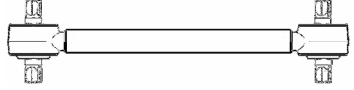

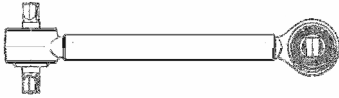
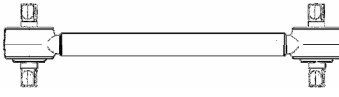
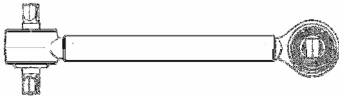
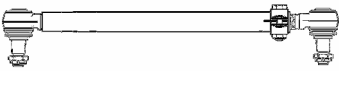
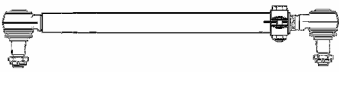
Originalni broj Cross-Ref.-No. Original Nr.	Br. FAD No. Nr.	Naziv Designation Bezeichnung	Kugla Ball Ø Größe	Konus Taper Konus	Dužina Length Länge	Skica Figure Bild
<b>355 460 15 05</b> 355 460 59 05 355 460 60 05	<b>3305.00.00</b>	Spona upravljača Drag link Lenkstange	35	K26	650 RØ40	
<b>355 460 23 05</b> 355 460 28 05 355 460 47 05	<b>4526.00.00</b>	Spona upravljača Drag link Lenkstange	40	K30	618 RØ42	
<b>356 330 00 03</b> 613 330 00 03	<b>6050.00.00</b>	Poprečna spona Tie rod Spurstange  Izmenljivi delovi Parts list Stuckliste 6050.10.00 6050.20.00	40	K30	697 RØ32	
<b>356 330 01 03</b> 613 330 01 03	<b>6054.00.00</b>	Poprečna spona Tie rod Spurstange	40	K30	506 RØ30	
<b>356 330 02 03</b>	<b>6051.00.00</b>	Poprečna spona Tie rod Spurstange  Izmenljivi delovi Parts list Stuckliste 6050.10.00 6050.20.00	40	K30	648 RØ32	
<b>356 350 01 06</b>	<b>5708.00.00</b>	Vodica mosta Torque rod Achsstrebe  Izmenljivi delovi Parts list Stuckliste 5705.96.00 6071.96.00	80/62	Ø17 >24< <130> K45	628 RØ50	

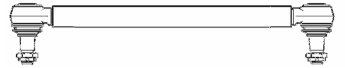
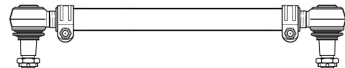
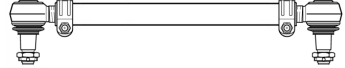
Originalni broj Cross-Ref.-No. Original Nr.	Br. FAD No. Nr.	Naziv Designation Bezeichnung	Kugla Ball Ø Größe	Konus Taper Konus	Dužina Length Länge	Skica Figure Bild
<b>356 463 00 15</b> 613 463 00 15	<b>6053.00.00</b>	Spona upravljača Drag link Lenkstange Izmenljivi delovi Parts list Stuckliste 5743.10.00 5743.20.00	40	K30	1708 RØ58	
<b>356 463 02 15</b>	<b>6052.00.00</b>	Spona upravljača Drag link Lenkstange  Izmenljivi delovi Parts list Stuckliste 5743.10.00 5743.20.00	40	K30	1453 RØ50	
<b>357 330 00 35</b>	<b>5522.96.00</b>	Izmenljivi podsklop Repair kit Reparatur satz	45	Ø15 >20<	<90>	
<b>357 330 02 03</b> 357 330 04 03 357 330 05 03	<b>3444.00.00</b>	Poprečna spona Tie rod Spurstange  Izmenljivi delovi Parts list Stuckliste 5848.10.00 5848.20.00	35	K26	1740 RØ40	
<b>357 330 06 03</b> 357 330 07 03	<b>5976.00.00</b>	Poprečna spona Tie rod Spurstange  Izmenljivi delovi Parts list Stuckliste 5741.20.00	35	K26	1725 RØ50	



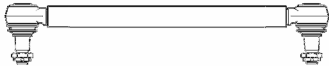
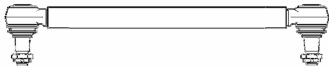
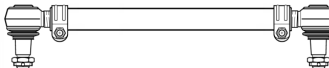

Originalni broj Cross-Ref.-No. Original Nr.	Br. FAD No. Nr.	Naziv Designation Bezeichnung	Kugla Ball Ø Größe	Konus Taper Konus	Dužina Length Länge	Skica Figure Bild
<b>357 330 11 03</b> 357 330 15 03	<b>6901.00.00</b>	Poprečna spona Tie rod Spurstange  Izmenljivi delovi Parts list Stuckliste 5741.10.00 5741.20.00	35	K26	1705  RØ40	
<b>357 330 17 11</b>	<b>3952.00.00</b>	Vođica mosta Torque rod Achsstrebe  Izmenljivi delovi Parts list Stuckliste 3310.96.00	70	Ø16 >30< <130>	960  RØ56	
<b>357 330 19 11</b> 357 330 33 11	<b>6910.00.00</b>	Vođica mosta Torque rod Achsstrebe  Izmenljivi delovi Parts list Stuckliste 3310.96.00	70	Ø16 >30< <130>	713  RØ56	
<b>357 333 02 05</b>	<b>5956.00.00</b>	Vođica mosta Torque rod Achsstrebe  Izmenljivi delovi Parts list Stuckliste 5170.96.00	70	Ø19 >30< <130>	750  RØ50	
<b>357 333 04 05</b>	<b>6039.00.00</b>	Vođica mosta Torque rod Achsstrebe  Izmenljivi delovi Parts list Stuckliste 5522.96.00	45	Ø15 >20< <90>	625  RØ36	

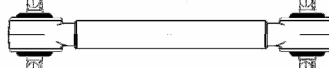
Originalni broj Cross-Ref.-No. Original Nr.	Br. FAD No. Nr.	Naziv Designation Bezeichnung	Kugla Ball Ø Größe	Konus Taper Konus	Dužina Length Länge	Skica Figure Bild
<b>357 333 05 05</b> 671 333 02 05	<b>6905.00.00</b>	Vodica mosta Torque rod Achsstrebe  Izmenljivi delovi Parts list Stuckliste 5323.96.00	62	Ø17 >24< <115>	659  RØ50	
<b>357 333 06 05</b> 357 333 09 05	<b>4488.00.00</b>	Vodica mosta Torque rod Achsstrebe  Izmenljivi delovi Parts list Stuckliste 5128.90.00	55	Ø19 >30< <130>	662  RØ50	
<b>357 333 07 05</b> 671 333 04 05	<b>6906.00.00</b>	Vodica mosta Torque rod Achsstrebe  Izmenljivi delovi Parts list Stuckliste 5323.96.00	62	Ø17 >24< <115>	659  RØ50	
<b>357 460 04 05</b> 357 460 10 05 357 460 11 05	<b>5865.00.00</b>	Spona upravljača Drag link Lenkstange  Izmenljivi delovi Parts list Stuckliste 5741.20.00	35	K26	988  RØ40	
<b>357 460 14 05</b> 357 460 15 05	<b>3967.00.00</b>	Spona upravljača Drag link Lenkstange  Izmenljivi delovi Parts list Stuckliste 5741.20.00	35	K26	1066  RØ40	



Originalni broj Cross-Ref.No. Original Nr.	Br. FAD No. Nr.	Naziv Designation Bezeichnung	Kugla Ball Ø Größe	Konus Taper Konus	Dužina Length Länge	Skica Figure Bild
<b>357 460 32 05</b> 671 460 03 05	<b>6902.00.00</b>	Spona upravljača Drag link Lenkstange	40	K30	920 RØ36	
<b>357 460 35 05</b> 942 330 10 03 942 330 17 03 942 330 25 03	<b>4580.00.00</b>	Poprečna spona Tie rod Spurstange  Izmenljivi delovi Parts list Stuckliste 5743.10.00 5743.20.00	40	K30	1281 RØ40	
<b>358 330 01 03</b> 358 330 05 03 381 330 03 03 381 330 05 03 381 330 06 03 381 330 07 03	<b>5747.00.00</b>	Poprečna spona Tie rod Spurstange  Izmenljivi delovi Parts list Stuckliste 5746.10.00 5746.20.00	30	K22	1638 RØ46	
<b>360 460 03 05</b> 360 460 09 05 360 460 22 05	<b>5885.00.00</b>	Spona upravljača Drag link Lenkstange  Izmenljivi delovi Parts list Stuckliste 5746.20.00	35	K22	678 RØ42	
<b>363 460 00 05</b> 363 460 06 05 363 460 07 05	<b>5792.00.00</b>	Spona upravljača Drag link Lenkstange  Izmenljivi delovi Parts list Stuckliste 5742.20.00	40/35	K26	1010 RØ40	

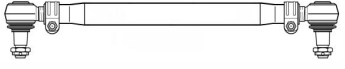

Originalni broj Cross-Ref.No. Original Nr.	Br. FAD No. Nr.	Naziv Designation Bezeichnung	Kugla Ball Ø Größe	Konus Taper Konus	Dužina Length Länge	Skica Figure Bild
<b>365 460 06 05</b>	<b>3724.00.00</b>	Spona upravljača Drag link Lenkstange	35	K26	662 RØ36	
<b>366 460 07 05</b>	<b>3725.00.00</b>	Spona upravljača Drag link Lenkstange	35	K26	1730 RØ40	
<b>366 460 08 05</b>	<b>3726.00.00</b>	Spona upravljača Drag link Lenkstange Izmenljivi delovi Parts list Stuckliste 5742.10.00 5742.20.00	40	K26	650 RØ40	
<b>371 330 70 03</b> 393 330 00 03 393 330 02 03 393 330 03 03 393 330 04 03	<b>5743.00.00</b>	Poprečna spona Tie rod Spurstange Izmenljivi delovi Parts list Stuckliste 5743.10.00 5743.20.00	40	K30	1615 RØ50	
<b>373 460 03 05</b> 373 460 05 05 373 460 07 05 373 460 35 05 373 460 36 05	<b>5722.00.00</b>	Spona upravljača Drag link Lenkstange Izmenljivi delovi Parts list Stuckliste 5741.20.00	35	K26	976 RØ40	
<b>375 460 06 05</b> 375 460 11 05	<b>6922.00.00</b>	Spona upravljača Drag link Lenkstange Izmenljivi delovi Parts list Stuckliste 5741.20.00	35	K28,6	909 RØ42	
<b>381 350 02 06</b> 383 350 00 06	<b>5770.00.00</b>	Vođica mosta Torque rod Achsstrebe Izmenljivi delovi Parts list Stuckliste 3755.90.00	65	Ø21 >24< <152>	595 RØ50	

Originalni broj Cross-Ref.-No. Original Nr.	Br. FAD No. Nr.	Naziv Designation Bezeichnung	Kugla Ball Ø Größe	Konus Taper Konus	Dužina Length Länge	Skica Figure Bild
<b>381 350 03 06</b> 385 350 02 06	<b>3697.00.00</b>	Vodica mosta Torque rod Achsstrebe Izmenljivi delovi Parts list Stuckliste 3755.90.00 3991.90.00	65	Ø21 >24< <152> K45	612  RØ50	
<b>381 350 06 06</b> 652 350 03 06 653 350 01 06	<b>5705.00.00</b>	Vodica mosta Torque rod Achsstrebe Izmenljivi delovi Parts list Stuckliste 3744.96.00 5705.96.00	78.5/ 70	Ø21 >24< <152> K45	522  RØ52	
<b>381 350 06 06</b> 652 350 03 06 653 350 01 06	<b>5846.00.00</b>	Vodica mosta Torque rod Achsstrebe Izmenljivi delovi Parts list Stuckliste 3755.90.00 5846.90.00	65	Ø21 >24< <152> K38	522  RØ52	
<b>383 350 01 05</b> 393 350 52 05 393 350 53 05 393 350 54 05 393 350 55 05 653 350 01 05 653 353 00 05 658 350 00 05	<b>3503.00.00</b>	V-Vodica mosta Triangular torque rod Dreieckslenker  Izmenljivi delovi Parts list Stuckliste 3755.90.00 3500.90.00	80/65	Ø21 >24< <152> K40	623  RØ60	
<b>383 350 03 11</b> 654 330 00 11 654 330 01 11	<b>3431.00.00</b>	Vodica mosta Torque rod Achsstrebe Izmenljivi delovi Parts list Stuckliste 3431.10.00 3431.20.00	47	Ø15 >22< <110>	550  RØ50	

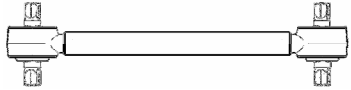
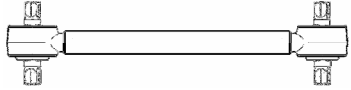
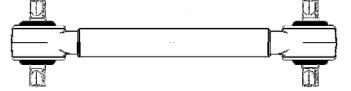
Originalni broj Cross-Ref.-No. Original Nr.	Br. FAD No. Nr.	Naziv Designation Bezeichnung	Kugla Ball Ø Größe	Konus Taper Konus	Dužina Length Länge	Skica Figure Bild
<b>383 460 08 05</b> 383 460 16 05 383 460 24 05 383 460 45 05	<b>5748.00.00</b>	Spona upravljača Drag link Lenkstange Izmenljivi delovi  Parts list Stuckliste 5748.20.00	35	K22	890  RØ40	
<b>383 460 14 05</b>	<b>5734.00.00</b>	Spona upravljača Drag link Lenkstange Izmenljivi delovi Parts list Stuckliste 5742.20.00	40	K26	890  RØ40	
<b>385 330 01 03</b> 385 330 12 03 385 330 19 03 385 330 20 03	<b>5730.00.00</b>	Poprečna spona Tie rod Spurstange Izmenljivi delovi  Parts list Stuckliste 5741.10.00 5741.20.00	35	K26	1565  RØ46	
<b>385 330 02 03</b> 385 330 08 03 385 330 16 03 385 330 18 03	<b>3968.00.00</b>	Poprečna spona Tie rod Spurstange Izmenljivi delovi  Parts list Stuckliste 5741.20.00	35	K26	1635  RØ52	
<b>385 330 05 03</b> 385 330 06 03 385 330 11 03 385 330 14 03 385 330 15 03	<b>5741.00.00</b>	Poprečna spona Tie rod Spurstange Izmenljivi delovi  Parts list Stuckliste 5741.10.00 5741.20.00	35	K26	1611  RØ46	

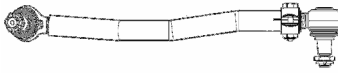

Originalni broj Cross-Ref.-No. Original Nr.	Br. FAD No. Nr.	Naziv Designation Bezeichnung	Kugla Ball Ø Größe	Konus Taper Konus	Dužina Length Länge	Skica Figure Bild
<b>385 350 00 06</b> 653 350 00 06	<b>5773.00.00</b>	Vodica mosta Torque rod Achsstrebe Izmenljivi delovi Parts list Stuckliste 3755.90.00	65	Ø21 >24< <152>	500  RØ50	
<b>385 350 00 06</b> 653 350 00 06	<b>5891.00.00</b>	Vodica mosta Torque rod Achsstrebe Izmenljivi delovi Parts list Stuckliste 3744.96.00	70	Ø21 >24< <152>	500  RØ50	
<b>385 350 01 06</b> 395 320 03 32	<b>3751.00.00</b>	Vodica mosta Torque rod Achsstrebe Izmenljivi delovi Parts list Stuckliste 3755.96.00	65	Ø21 >24< <152>	610  RØ50	
<b>385 460 08 05</b> 385 460 20 05 385 460 34 05	<b>5799.00.00</b>	Spona upravljача Drag link Lenkstange Izmenljivi delovi Parts list Stuckliste 5741.20.00	35	K26	865  RØ42	
<b>387 460 00 05</b> 387 460 48 05 387 460 49 05	<b>5793.00.00</b>	Spona upravljача Drag link Lenkstange Izmenljivi delovi Parts list Stuckliste 5742.20.00	35/40	K26	880  RØ40	

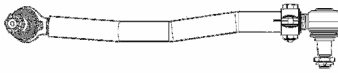
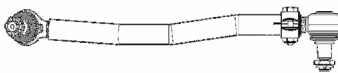



Originalni broj Cross-Ref.-No. Original Nr.	Br. FAD No. Nr.	Naziv Designation Bezeichnung	Kugla Ball Ø Größe	Konus Taper Konus	Dužina Length Länge	Skica Figure Bild
<b>387 460 00 05</b>	<b>3720.00.00</b>	Spona upravljajača Drag link Lenkstange Izmenljivi delovi Parts list Stuckliste 5742.20.00	35/40	K26	880  RØ40	
<b>387 460 04 05</b> 387 460 50 05 620 460 00 05 620 460 20 05 620 460 28 05 620 460 37 05	<b>5749.00.00</b>	Spona upravljajača Drag link Lenkstange Izmenljivi delovi Parts list Stuckliste 5743.20.00	40	K30	885  RØ40	
<b>387 460 06 05</b> 387 460 44 05 387 460 45 05	<b>5812.00.00</b>	Spona upravljajača Drag link Lenkstange  Izmenljivi delovi Parts list Stuckliste 5742.20.00	35	K26	865  RØ40	
<b>387 460 07 05</b> 387 460 14 05 387 460 32 05 387 460 33 05 647 460 00 05 647 460 01 05	<b>5811.00.00</b>	Spona upravljajača Drag link Lenkstange  Izmenljivi delovi Parts list Stuckliste 5743.20.00	40	K30	865  RØ40	
<b>387 460 07 05</b> 387 460 14 05 387 460 32 05 387 460 33 05 647 460 00 05 647 460 01 05	<b>5839.00.00</b>	Spona upravljajača Drag link Lenkstange Izmenljivi delovi Parts list Stuckliste 5743.20.00	40	K30	865  RØ40	

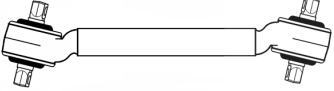
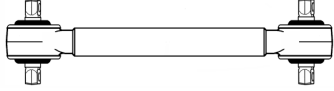
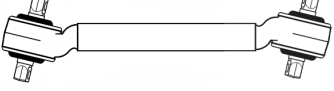
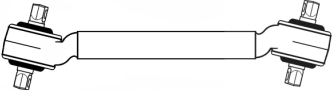
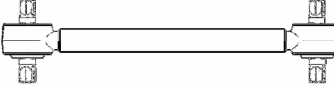

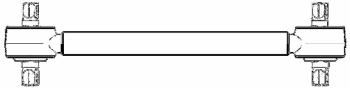

Originalni broj Cross-Ref.-No. Original Nr.	Br. FAD No. Nr.	Naziv Designation Bezeichnung	Kugla Ball Ø Größe	Konus Taper Konus	Dužina Length Länge	Skica Figure Bild
<b>387 460 15 05</b> 387 460 35 05 387 460 36 05 647 460 02 05 647 460 03 05	<b>5860.00.00</b>	Spona upravljača Drag link Lenkstange  Izmenljivi delovi Parts list Stuckliste 5743.20.00	40	K30	865  RØ42	
<b>387 460 15 05</b> 387 460 35 05 387 460 36 05 647 460 02 05 647 460 03 05	<b>5873.00.00</b>	Spona upravljača Drag link Lenkstange Izmenljivi delovi Parts list Stuckliste 5743.20.00	40	K30	865  RØ40	
<b>389 320 07 32</b>	<b>5771.00.00</b>	Vođica mosta Torque rod Achsstrebe Izmenljivi delovi Parts list Stuckliste 3755.90.00	65	Ø21 >24< <152>	582  RØ50	
<b>389 320 08 32</b>	<b>5772.00.00</b>	Vođica mosta Torque rod Achsstrebe Izmenljivi delovi Parts list Stuckliste 3755.90.00	65	Ø21 >24< <152>	614  RØ50	
<b>389 330 01 03</b>	<b>3722.00.00</b>	Poprečna spona Tie rod Spurstange Izmenljivi delovi Parts list Stuckliste 5741.10.00 5741.20.00	35	K26	1620  RØ50	

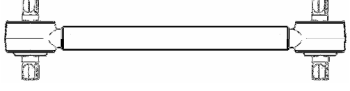
Originalni broj Cross-Ref.-No. Original Nr.	Br. FAD No. Nr.	Naziv Designation Bezeichnung	Kugla Ball Ø Größe	Konus Taper Konus	Dužina Length Länge	Skica Figure Bild
<b>391 330 04 03</b> 391 330 07 03 391 330 09 03 391 330 11 03	<b>3716.00.00</b>	Poprečna spona Tie rod Spurstange  Izmenljivi delovi Parts list Stuckliste 5741.10.00 5741.20.00	35	K26	1245  RØ40	
<b>391 330 06 03</b> 391 330 08 03 391 330 10 03 391 330 12 03	<b>5872.00.00</b>	Poprečna spona Tie rod Spurstange  Izmenljivi delovi Parts list Stuckliste 5741.10.00 5741.20.00	35	K26	1190  RØ46	
<b>391 460 09 05</b> 391 460 17 05 391 460 18 05	<b>3987.00.00</b>	Spona upravljajača Drag link Lenkstange	40	K30	1862  RØ40	
<b>393 320 01 32</b> 655 350 00 06 658 350 00 06 658 350 02 06	<b>3742.00.00</b>	Vođica mosta Torque rod Achsstrebe Izmenljivi delovi Parts list Stuckliste 3755.90.00	65	Ø21 >24< <152>	585  RØ50	
<b>393 320 02 32</b>	<b>3753.00.00</b>	Vođica mosta Torque rod Achsstrebe  Izmenljivi delovi Parts list Stuckliste 3755.90.00	65	Ø21 >24< <152>	627  RØ50	

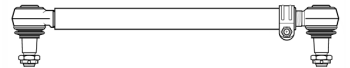

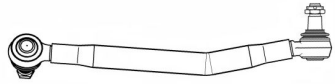
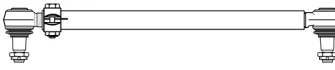
Originalni broj Cross-Ref.-No. Original Nr.	Br. FAD No. No.	Naziv Designation Bezeichnung	Kugla Ball Ø Größe	Konus Taper Konus	Dužina Length Länge	Skica Figure Bild
<b>393 320 03 32</b>	<b>3758.00.00</b>	Vodica mosta Torque rod Achsstrebe Izmenljivi delovi Parts list Stuckliste 3755.90.00	65	Ø21 >24< <152>	553  RØ50	
<b>393 320 04 32</b>	<b>3754.00.00</b>	Vodica mosta Torque rod Achsstrebe Izmenljivi delovi Parts list Stuckliste 3755.90.00	65	Ø21 >24< <152>	620  RØ50	
<b>395 320 01 32</b>	<b>3752.00.00</b>	Vodica mosta Torque rod Achsstrebe Izmenljivi delovi Parts list Stuckliste 3755.90.00	65	Ø21 >24< <152>	570  RØ50	
<b>395 320 14 32</b>	<b>3755.00.00</b>	Vodica mosta Torque rod Achsstrebe Izmenljivi delovi Parts list Stuckliste 3755.90.00	65	Ø21 >24< <152>	638  RØ50	
<b>395 320 15 32</b>	<b>5739.00.00</b>	Vodica mosta Torque rod Achsstrebe Izmenljivi delovi Parts list Stuckliste 3755.90.00	65	Ø21 >24< <152>	628  RØ50	
<b>395 350 02 06</b> 659 350 01 06 659 350 24 06	<b>3744.00.00</b>	Vodica mosta Torque rod Achsstrebe Izmenljivi delovi Parts list Stuckliste 3744.96.00	70	Ø21 >24< <152>	585  RØ50	

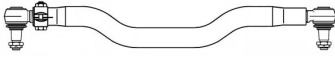
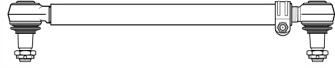

Originalni broj Cross-Ref.-No. Original Nr.	Br. FAD No. No.	Naziv Designation Bezeichnung	Kugla Ball Ø Größe	Konus Taper Konus	Dužina Length Länge	Skica Figure Bild
<b>395 350 02 06</b> 659 350 01 06 659 350 24 06	<b>5842.00.00</b>	Vodica mosta Torque rod Achsstrebe Izmenljivi delovi Parts list Stuckliste 3765.96.00	78.5	Ø21 >24< <152>	585 RØ58	
<b>395 350 05 06</b>	<b>3471.00.00</b>	Vodica mosta Torque rod Achsstrebe Izmenljivi delovi Parts list Stuckliste 3744.96.00	70	Ø21 >24< <152>	595 RØ50	
<b>395 350 06 06</b>	<b>5844.00.00</b>	Vodica mosta Torque rod Achsstrebe Izmenljivi delovi Parts list Stuckliste 3765.96.00	78.5	Ø21 >24< <152>	595 RØ58	
<b>395 350 07 06</b> 659 350 04 06 659 350 27 06	<b>3745.00.00</b>	Vodica mosta Torque rod Achsstrebe Izmenljivi delovi Parts list Stuckliste 3744.96.00	70	Ø21 >24< <152>	585 RØ50	
<b>395 350 08 06</b>	<b>3764.00.00</b>	Vodica mosta Torque rod Achsstrebe Izmenljivi delovi Parts list Stuckliste 3744.96.00	70	Ø21 >24< <152>	595 RØ50	
<b>395 350 10 06</b> 624 350 02 06 659 350 13 06 659 350 36 06	<b>3690.00.00</b>	Vodica mosta Torque rod Achsstrebe Izmenljivi delovi Parts list Stuckliste 3765.96.00	78.5	Ø21 >24< <152>	635 RØ58	

Originalni broj Cross-Ref.-No. Original Nr.	Br. FAD No. Nr.	Naziv Designation Bezeichnung	Kugla Ball Ø Größe	Konus Taper Konus	Dužina Length Länge	Skica Figure Bild
<b>395 350 10 06</b> 624 350 02 06 659 350 13 06 659 350 36 06	<b>5845.00.00</b>	Vodica mosta Torque rod Achsstrebe Izmenljivi delovi Parts list Stuckliste 3765.96.00	78.5	Ø21 >24< <152>	629  RØ58	
<b>395 350 11 06</b> 395 350 12 06 659 350 09 06 659 350 32 06	<b>3762.00.00</b>	Vodica mosta Torque rod Achsstrebe Izmenljivi delovi Parts list Stuckliste 3744.96.00	70	Ø21 >24< <152>	635  RØ50	
<b>395 350 11 06</b> 395 350 12 06 659 350 09 06 659 350 32 06	<b>3767.00.00</b>	Vodica mosta Torque rod Achsstrebe Izmenljivi delovi Parts list Stuckliste 3765.96.00	78.5	Ø21 >24< <152>	635  RØ58	
<b>395 350 13 06</b> 624 350 05 06 659 350 16 06 659 350 39 06	<b>3769.00.00</b>	Vodica mosta Torque rod Achsstrebe  Izmenljivi delovi Parts list Stuckliste 3769.96.00	90	Ø21 >24< <152>	629  RØ58	
<b>396 460 30 05</b> 396 460 48 05	<b>3958.00.00</b>	Spona upravljača Drag link Lenkstange  Izmenljivi delovi Parts list Stuckliste 5743.20.00	40	K30	975  RØ42	
<b>396 460 31 05</b> 396 460 49 05	<b>3959.00.00</b>	Spona upravljača Drag link Lenkstange Izmenljivi delovi Parts list Stuckliste 5743.20.00	40	K30	1370  RØ50	

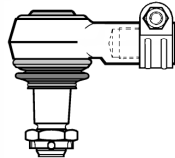
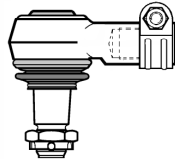
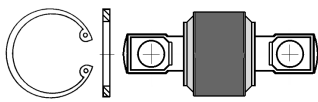
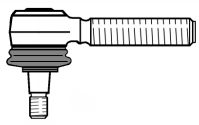
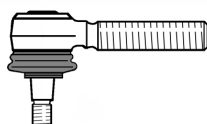
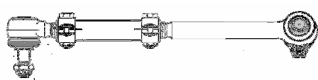

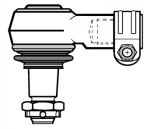
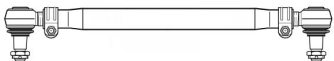
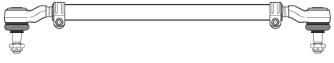
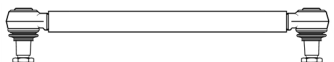
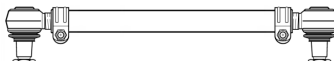

Originalni broj Cross-Ref.-No. Original Nr.	Br. FAD No. Nr.	Naziv Designation Bezeichnung	Kugla Ball Ø Größe	Konus Taper Konus	Dužina Length Länge	Skica Figure Bild
<b>396 460 53 05</b>	<b>4512.00.00</b>	Spona upravljača Drag link Lenkstange	40	K30	777 RØ50	
<b>396 460 59 05</b>	<b>4585.00.00</b>	Spona upravljača Drag link Lenkstange  Izmenljivi delovi Parts list Stuckliste 6832.20.00	40	K30	1100 RØ42	
<b>406 460 01 05</b>	<b>4552.00.00</b>	Spona upravljača Drag link Lenkstange  Izmenljivi delovi Parts list Stuckliste 7414.20.00	30	K20	1015 RØ36	
<b>424 330 03 03</b>	<b>4550.00.00</b>	Poprečna spona Tie rod Spurstange  Izmenljivi delovi Parts list Stuckliste 5741.10.00	35	K26	1170 RØ50	
<b>425 460 01 05</b> 425 460 02 05 425 460 03 05 425 460 04 05 427 460 00 05 427 460 01 05	<b>4594.00.00</b>	Spona upravljača Drag link Lenkstange Izmenljivi delovi Parts list Stuckliste 5741.20.00	35	K26	1000 RØ40	
<b>427 460 00 05</b> 427 460 01 05 427 460 03 05 427 460 04 05	<b>4560.00.00</b>	Spona upravljača Drag link Lenkstange  Izmenljivi delovi Parts list Stuckliste 5741.20.00	35	K26	882 RØ40	





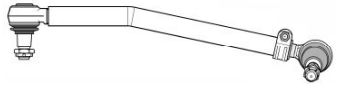
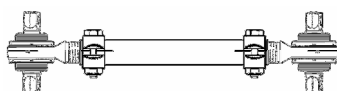

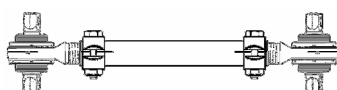
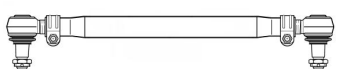

Originalni broj Cross-Ref.-No. Original Nr.	Br. FAD No. Nr.	Naziv Designation Bezeichnung	Kugla Ball Ø Größe	Konus Taper Konus	Dužina Length Länge	Skica Figure Bild
<b>440 460 03 48</b> 440 460 05 48	<b>3965.20.00</b>	Zglob,RH M18x1.5 * Ball joint, RH Kugelgelenk, RH	30	K22	70	
<b>440 460 03 48</b>	<b>7385.20.00</b>	Zglob,RH M18x1.5 * Ball joint, RH Kugelgelenk, RH	30	K22	70	
<b>444 333 01 27</b>	<b>6409.96.00</b>	Izmenljivi podsklop Repair kit Reparatur satz	55	Ø17 >24<	<115>	
<b>601 330 04 35</b>	<b>5886.20.00</b>	Zglob,RH M20x1.5 Ball joint, RH Kugelgelenk, RH	25	K18	95	
<b>601 330 05 35</b>	<b>5886.10.00</b>	Zglob,LH M20x1.5 Ball joint, LH Kugelgelenk, LH	25	K18	95	
<b>601 460 05 05</b> 601 460 06 05 601 460 07 05 601 460 08 05 601 460 09 05 601 460 10 05 601 460 11 05 601 460 12 05 601 460 13 05 601 460 15 05	<b>5852.00.00</b>	Spona upravljača Drag link Lenkstange  Izmenljivi delovi Parts list Stuckliste 5774.20.00	30	K18	483 RØ26	
<b>602 330 00 03</b> 602 330 01 03 602 330 03 03 602 330 52 03	<b>5886.00.00</b>	Poprečna spona Tie rod Spurstange  Izmenljivi delovi Parts list Stuckliste 5886.20.00	25	K18	1356 RØ32	

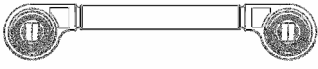
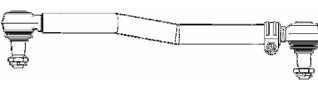
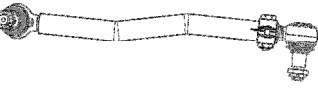
Originalni broj Cross-Ref.-No. Original Nr.	Br. FAD No. No.	Naziv Designation Bezeichnung	Kugla Ball Ø Größe	Konus Taper Konus	Dužina Length Länge	Skica Figure Bild
<b>602 330 02 05</b> 602 330 03 05	<b>5895.20.00</b>	Zglob,RH M22x1.5 * Ball joint, RH Kugelgelenk, RH	30	K20	85	
<b>602 330 09 03</b> 602 330 10 03 602 330 53 03 602 330 54 03	<b>3924.00.00</b>	Poprečna spona Tie rod Spurstange  Izmenljivi delovi Parts list Stuckliste 5798.10.00 5798.20.00	25	K18	1355  RØ36	
<b>602 330 09 03</b> 602 330 10 03 602 330 53 03 602 330 54 03	<b>5703.00.00</b>	Poprečna spona Tie rod Spurstange  Izmenljivi delovi Parts list Stuckliste 5703.10.00 5703.20.00	30	K18	1356  RØ36	
<b>608 330 04 03</b>	<b>1708.00.00</b>	Poprečna spona Tie rod Spurstange	22	K14	312  RØ20	
<b>617 330 02 03</b> 617 330 03 03	<b>3978.00.00</b>	Poprečna spona Tie rod Spurstange  Izmenljivi delovi Parts list Stuckliste 5743.10.00 5743.20.00	40	K30	1611  RØ42	
<b>617 460 00 05</b> 617 460 02 05 617 460 28 05	<b>5821.00.00</b>	Spona upravljača Drag link Lenkstange Izmenljivi delovi Parts list Stuckliste 5742.20.00	40	K26	870  RØ42	

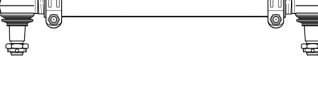
Originalni broj Cross-Ref.-No. Original Nr.	Br. FAD No. Nr.	Naziv Designation Bezeichnung	Kugla Ball Ø Größe	Konus Taper Konus	Dužina Length Länge	Skica Figure Bild
<b>617 460 24 05</b> 617 460 34 05	<b>3969.00.00</b>	Spona upravljača Drag link Lenkstange  Izmenljivi delovi Parts list Stuckliste 5743.20.00	40	K30	863  RØ42	
<b>617 460 30 05</b> 617 460 31 05	<b>4583.00.00</b>	Spona upravljača Drag link Lenkstange  Izmenljivi delovi Parts list Stuckliste 5743.20.00	40	K30	870  RØ42	
<b>617 460 32 05</b> 617 460 33 05	<b>5890.00.00</b>	Spona upravljača Drag link Lenkstange  Izmenljivi delovi Parts list Stuckliste 5743.20.00	40	K30	870  RØ42	
<b>619 460 04 05</b> 619 460 19 05 619 460 45 05	<b>3988.00.00</b>	Spona upravljača Drag link Lenkstange	40	K30	1670  RØ50	
<b>619 460 06 05</b> 619 460 21 05 619 460 47 05	<b>3999.00.00</b>	Spona upravljača Drag link Lenkstange	40	K30	1153  RØ50	
<b>619 460 20 05</b> 619 460 46 05	<b>4546.00.00</b>	Spona upravljača Drag link Lenkstange	40	K30	1553  RØ50	

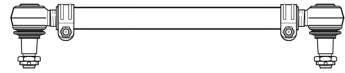
Originalni broj Cross-Ref.-No. Original Nr.	Br. FAD No. Nr.	Naziv Designation Bezeichnung	Kugla Ball Ø Größe	Konus Taper Konus	Dužina Length Länge	Skica Figure Bild
<b>619 460 25 05</b> 619 460 29 05 619 460 52 05	<b>3708.00.00</b>	Spona upravljača Drag link Lenkstange Izmenljivi delovi Parts list Stuckliste 5743.20.00	40	K30	860 RØ42	
<b>620 330 02 11</b>	<b>3433.00.00</b>	Vođica mosta Torque rod Achsstrebe Izmenljivi delovi Parts list Stuckliste 3431.10.00 3433.20.00	47	Ø15 >22< <110>	600 RØ50	
<b>620 330 03 03</b> 620 330 04 03 620 330 07 03 620 330 08 03	<b>5836.00.00</b>	Poprečna spona Tie rod Spurstange Izmenljivi delovi Parts list Stuckliste 5743.20.00	40	K30	1692 RØ50	
<b>620 330 03 11</b>	<b>3435.00.00</b>	Vođica mosta Torque rod Achsstrebe Izmenljivi delovi Parts list Stuckliste 3431.10.00 3432.20.00	53/47	Ø18/ Ø15 >24</ >22< <102>/ <110>	600 RØ50	
<b>620 330 05 03</b> 620 330 06 03	<b>5864.00.00</b>	Poprečna spona Tie rod Spurstange Izmenljivi delovi Parts list Stuckliste 5743.10.00 5743.20.00	40	K30	1665 RØ50	
<b>620 350 00 06</b> 620 350 01 06 655 350 03 06	<b>5851.00.00</b>	Vođica mosta Torque rod Achsstrebe Izmenljivi delovi Parts list Stuckliste 3755.90.00	65	Ø21 >24< <152>	595 RØ62	

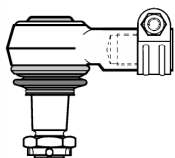
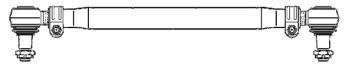



Originalni broj Cross-Ref.-No. Original Nr.	Br. FAD No. Nr.	Naziv Designation Bezeichnung	Kugla Ball Ø Größe	Konus Taper Konus	Dužina Length Länge	Skica Figure Bild
<b>620 350 00 06</b> 620 350 01 06 655 350 03 06	<b>5858.00.00</b>	Vođica mosta Torque rod Achsstrebe  Izmenljivi delovi Parts list Stuckliste 3744.90.00	70	Ø21 >24< <152>	595  RØ62	
<b>620 460 01 05</b> 620 460 21 05 620 460 38 05 620 460 39 05	<b>5822.00.00</b>	Spona upravljača Drag link Lenkstange  Izmenljivi delovi Parts list Stuckliste 5743.20.00	40	K30	885  RØ40	
<b>620 460 04 05</b> 620 460 08 05 620 460 29 05 620 460 30 05	<b>3971.00.00</b>	Spona upravljača Drag link Lenkstange  Izmenljivi delovi Parts list Stuckliste 5743.20.00	40	K30	865  RØ40	
<b>620 460 24 05</b> 620 460 26 05 620 460 40 05 620 460 41 05	<b>3938.00.00</b>	Spona upravljača Drag link Lenkstange  Izmenljivi delovi Parts list Stuckliste 5743.20.00	40	K30.	900  RØ50	
<b>622 460 02 05</b> 622 460 03 05 622 460 09 05 622 460 10 05	<b>3976.00.00</b>	Spona upravljača Drag link Lenkstange  Izmenljivi delovi Parts list Stuckliste 5743.10.00 5743.20.00	40	K30	700  RØ42	

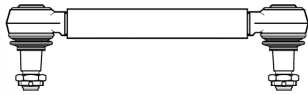
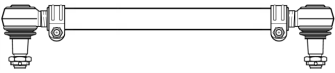
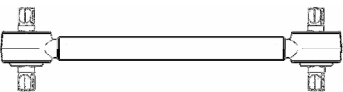

Originalni broj Cross-Ref.-No. Original Nr.	Br. FAD No. Nr.	Naziv Designation Bezeichnung	Kugla Ball Ø Größe	Konus Taper Konus	Dužina Length Länge	Skica Figure Bild
<b>622 460 04 05</b> 622 460 14 05 622 460 15 05	<b>3975.00.00</b>	Spona upravljača Drag link Lenkstange Izmenljivi delovi Parts list Stuckliste 5743.10.00 5743.20.00	40	K30	820  RØ42	
<b>624 350 01 06</b> 659 350 12 06 659 350 35 06	<b>3759.00.00</b>	Vođica mosta Torque rod Achsstrebe Izmenljivi delovi Parts list Stuckliste 3744.90.00	70	Ø21 >24< <152>	579  RØ50	
<b>624 350 03 06</b> 659 350 14 06 659 350 37 06	<b>3761.00.00</b>	Vođica mosta Torque rod Achsstrebe Izmenljivi delovi Parts list Stuckliste 3744.96.00	70	Ø21 >24< <152>	629  RØ50	
<b>624 460 03 48</b>	<b>6107.20.00</b>	Zglob,RH26x1.5 * Ball joint, RH Kugelgelenk, RH	50	K38	85	
<b>625 330 03 03</b> 625 330 20 03 625 330 21 03 625 330 26 03 625 330 27 03 942 330 05 03 942 330 06 03 942 330 09 03	<b>4458.00.00</b>	Poprečna spona Tie rod Spurstange Izmenljivi delovi Parts list Stuckliste 5855.10.00 5855.20.00	40	K32	1565  RØ52	
<b>625 330 04 03</b>	<b>5874.00.00</b>	Poprečna spona Tie rod Spurstange Izmenljivi delovi Parts list Stuckliste 5856.20.00	40	K30	1588  RØ58	

Originalni broj Cross-Ref.-No. Original Nr.	Br. FAD No. No.	Naziv Designation Bezeichnung	Kugla Ball Ø Größe	Konus Taper Konus	Dužina Length Länge	Skica Figure Bild
<b>625 330 09 03</b> 625 330 12 03 944 330 02 03	<b>3937.00.00</b>	Poprečna spona Tie rod Spurstange Izmenljivi delovi Parts list Stuckliste 3581.20.00	50	K38	1588 RØ60	
<b>625 330 15 03</b> 625 330 16 03 625 330 24 03 625 330 25 03	<b>3974.00.00</b>	Poprečna spona Tie rod Spurstange Izmenljivi delovi Parts list Stuckliste 5855.10.00 5855.20.00	40	K32	1615 RØ50	
<b>625 330 26 03</b> 625 330 27 03	<b>3977.00.00</b>	Poprečna spona Tie rod Spurstange Izmenljivi delovi Parts list Stuckliste 5855.10.00 5855.20.00	40	K32	1565 RØ50	
<b>625 330 32 03</b> 944 330 17 03	<b>4567.00.00</b>	Poprečna spona Tie rod Spurstange Izmenljivi delovi Parts list Stuckliste 5743.20.00	40	K30	1588 RØ50	
<b>625 350 01 06</b>	<b>3699.00.00</b>	Vodica mosta Torque rod Achsstrebe Izmenljivi delovi Parts list Stuckliste 3769.90.00	90	Ø21 >24< <152>	645 RØ58	
<b>625 460 25 05</b>	<b>5907.00.00</b>	Spona upravljača Drag link Lenkstange Izmenljivi delovi Parts list Stuckliste 5743.20.00	40	K30	870 RØ42	

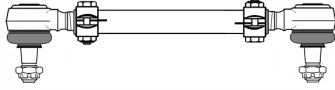

Originalni broj Cross-Ref.-No. Original Nr.	Br. FAD No. Nr.	Naziv Designation Bezeichnung	Kugla Ball Ø Größe	Konus Taper Konus	Dužina Length Länge	Skica Figure Bild
<b>625 460 44 05</b>	<b>3923.00.00</b>	Spona upravljača Drag link Lenkstange Izmenljivi delovi Parts list Stuckliste 5743.20.00	40	K30	905 RØ42	
<b>628 330 04 03</b> 628 330 05 03	<b>6909.00.00</b>	Poprečna spona Tie rod Spurstange Izmenljivi delovi Parts list Stuckliste 5741.10.00 5741.20.00	35	K26	768 RØ40	
<b>628 333 00 03</b> 628 333 00 05 628 333 10 05 628 333 18 05	<b>6885.00.00</b>	Vodica mosta Torque rod Achsstrebe  Izmenljivi delovi Parts list Stuckliste 5942.96.00	70	Ø19 >24< <130>	664 RØ50	
<b>628 333 01 05</b>	<b>6918.00.00</b>	Vodica mosta Torque rod Achsstrebe  Izmenljivi delovi Parts list Stuckliste 4569.96.00	62	Ø19 >24< <130>	576 RØ50	
<b>628 333 09 05</b> 628 333 17 05	<b>6913.00.00</b>	Vodica mosta Torque rod Achsstrebe  Izmenljivi delovi Parts list Stuckliste 5942.96.00	70	Ø19 >24< <130>	576 RØ50	
<b>628 460 03 05</b> 628 460 12 05	<b>4576.00.00</b>	Spona upravljača Drag link Lenkstange	40	K30	928 RØ42	

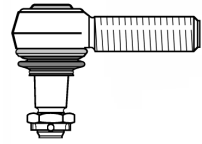
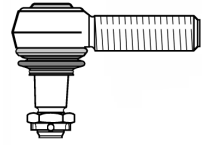
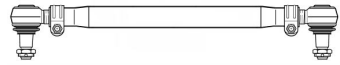
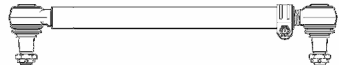
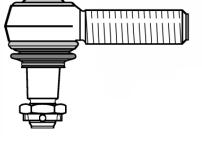



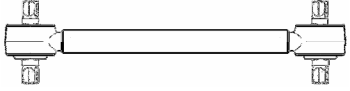
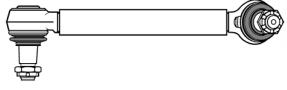
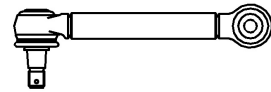
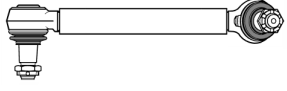
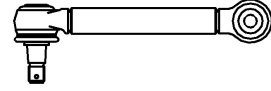
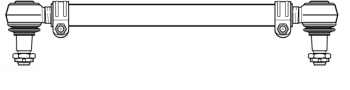

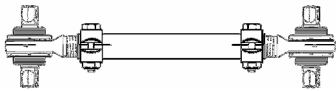
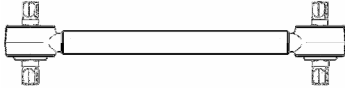
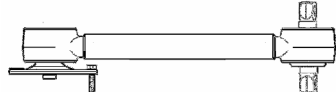
Originalni broj Cross-Ref.-No. Original Nr.	Br. FAD No. No.	Naziv Designation Bezeichnung	Kugla Ball Ø Größe	Konus Taper Konus	Dužina Length Länge	Skica Figure Bild
<b>628 460 20 05</b>	<b>4595.00.00</b>	Poprečna spona Tie rod Spurstange	40	K30	566 RØ36	
<b>629 330 00 03</b> 629 330 06 03	<b>4581.00.00</b>	Spona upravljača Drag link Lenkstange Izmenljivi delovi Parts list Stuckliste 5743.10.00 5743.20.00	40	K30	880 RØ40	
<b>629 350 05 06</b> 629 350 06 06	<b>6197.00.00</b>	Vođica mosta Torque rod Achsstrebe Izmenljivi delovi Parts list Stuckliste 5170.96.00	70	Ø19 >30< <130>	658 RØ50	
<b>629 350 12 06</b> 629 350 28 06	<b>4566.00.00</b>	Vođica mosta Torque rod Achsstrebe Izmenljivi delovi Parts list Stuckliste 5942.96.00	70	Ø19 >24< <130>	628 RØ50	
<b>631 330 03 03</b>	<b>1703.00.00</b>	Poprečna spona Tie rod Spurstange  Izmenljivi delovi Parts list Stuckliste 1703.10.00 1703.20.00	25	K18	294 RØ24	
<b>631 330 04 03</b>	<b>1705.00.00</b>	Poprečna spona Tie rod Spurstange Izmenljivi delovi Parts list Stuckliste 1074.20.00	30	K20	650 RØ26	

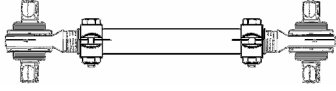
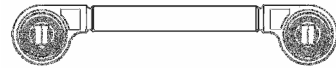

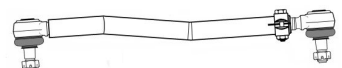
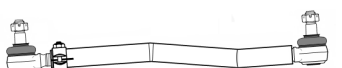

Originalni broj Cross-Ref.-No. Original Nr.	Br. FAD No. No.	Naziv Designation Bezeichnung	Kugla Ball Ø Größe	Konus Taper Konus	Dužina Length Länge	Skica Figure Bild
<b>631 330 04 10</b>	<b>1703.10.00</b>	Zglob,LH M18x1.5 Ball joint, LH Kugelgelenk, LH	25	K18	95	
<b>631 330 04 35</b>	<b>1704.20.00</b>	Zglob,RH M20x1.5 Ball joint, RH Kugelgelenk, RH	30	K20	95	
<b>631 330 05 03</b> 631 330 07 03	<b>1704.00.00</b>	Poprečna spona Tie rod Spurstange Izmenljivi delovi Parts list Stuckliste 1704.10.00 1704.20.00	30	K20	300 RØ26	
<b>631 330 06 03</b>	<b>1706.00.00</b>	Poprečna spona Tie rod Spurstange  Izmenljivi delovi Parts list Stuckliste 4746.20.00	30	K22	660 RØ30	
<b>631 338 03 10</b>	<b>1703.20.00</b>	Zglob,RH M18x1.5 Ball joint, RH Kugelgelenk, RH	25	K18	95	
<b>631 460 07 05</b>	<b>4536.00.00</b>	Spona upravljača Drag link Lenkstange Izmenljivi delovi Parts list Stuckliste 1703.20.00	25	K18	1243 RØ36	

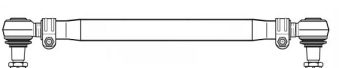

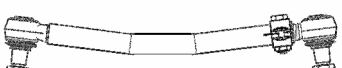
Originalni broj Cross-Ref.-No. Original Nr.	Br. FAD No. No.	Naziv Designation Bezeichnung	Kugla Ball Ø Größe	Konus Taper Konus	Dužina Length Länge	Skica Figure Bild
<b>632 350 01 06</b>	<b>6914.00.00</b>	Vodica mosta Torque rod Achsstrebe Izmenljivi delovi Parts list Stuckliste 5942.96.00	70	Ø19 >24< <130>	725 RØ50	
<b>634 323 02 16</b> 634 323 04 16	<b>4586.00.00</b>	Stabilizator Stabillizer link Koppelstang	35	K26	375 RØ36	
<b>634 323 03 16</b> 634 323 05 16	<b>4587.00.00</b>	Stabilizator Stabillizer link Koppelstang	35	K26	375 RØ36	
<b>634 326 00 16</b> 634 326 05 16	<b>4588.00.00</b>	Stabilizator Stabillizer link Koppelstang	35	K26	300 RØ36	
<b>634 326 01 16</b> 634 326 06 16	<b>4589.00.00</b>	Stabilizator Stabillizer link Koppelstang	35	K26	300 RØ36	
<b>634 460 05 05</b>	<b>3492.00.00</b>	Spona upravljajača Drag link Lenkstange Izmenljivi delovi Parts list Stuckliste 5742.10.00 5742.20.00	40	K26	670 RØ40	

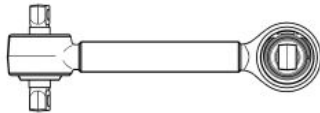
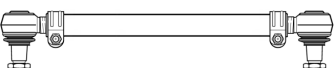
Originalni broj Cross-Ref.-No. Original Nr.	Br. FAD No. Nr.	Naziv Designation Bezeichnung	Kugla Ball Ø Größe	Konus Taper Konus	Dužina Length Länge	Skica Figure Bild
<b>653 330 00 11</b>	<b>3432.00.00</b>	Vodica mosta Torque rod Achsstrebe Izmenljivi delovi Parts list Stuckliste 3432.10.00 3432.20.00	53	Ø18/ Ø18.5 >24< <102>	550  RØ50	
<b>653 350 00 06</b> 385 350 00 06	<b>5891.00.00</b>	Vodica mosta Torque rod Achsstrebe Izmenljivi delovi Parts list Stuckliste 3744.96.00	70	Ø21 >24< <152>	500  RØ50	
<b>654 350 04 06</b> 654 350 05 06 654 352 00 05	<b>5706.00.00</b>	Vodica mosta Torque rod Achsstrebe Izmenljivi delovi Parts list Stuckliste 3744.96.00 5705.96.00	78.5/ 70	Ø21 >24< <152> K45	652  RØ52	
<b>654 350 04 06</b> 654 350 05 06 654 352 00 05	<b>5849.00.00</b>	Vodica mosta Torque rod Achsstrebe Izmenljivi delovi Parts list Stuckliste 3755.90.00 5846.90.00	65	Ø21 >24< <152> K38	652  RØ52	
<b>655 330 00 11</b>	<b>3434.00.00</b>	Vodica mosta Torque rod Achsstrebe Izmenljivi delovi Parts list Stuckliste 3432.10.00 3432.20.00	53	Ø18/ Ø18.5 >24< <102>	600  RØ50	
<b>655 350 03 06</b> 620 350 00 06 620 350 01 06	<b>5858.00.00</b>	Vodica mosta Torque rod Achsstrebe Izmenljivi delovi Parts list Stuckliste 3744.96.00	70	Ø21 >24< <152>	595  RØ62	

Originalni broj Cross-Ref.No. Original Nr.	Br. FAD No. Nr.	Naziv Designation Bezeichnung	Kugla Ball Ø Größe	Konus Taper Konus	Dužina Length Länge	Skica Figure Bild
<b>659 350 17 06</b>	<b>3760.00.00</b>	Vođica mosta Torque rod Achsstrebe  Izmenljivi delovi Parts list Stuckliste 3744.96.00	70	Ø21 >24< <152>	629  RØ50	
<b>662 460 08 05</b>	<b>4572.00.00</b>	Spona upravljača Drag link Lenkstange	40	K32	1295  RØ42	
<b>662 460 09 05</b>	<b>4571.00.00</b>	Spona upravljača Drag link Lenkstange  Izmenljivi delovi Parts list Stuckliste 5855.10.00 5855.20.00	40	K32	853  RØ36	
<b>666 330 00 11</b>	<b>6919.00.00</b>	Vođica mosta Torque rod Achsstrebe Izmenljivi delovi Parts list Stuckliste 4569.96.00	62	Ø19 >24< <130>	710  RØ50	
<b>667 460 15 05</b> 667 460 17 05	<b>4534.00.00</b>	Spona upravljača Drag link Lenkstange  Izmenljivi delovi Parts list Stuckliste 5746.20.00	30	K22	504  RØ36	
<b>667 460 16 05</b> 667 460 18 05	<b>4573.00.00</b>	Spona upravljača Drag link Lenkstange  Izmenljivi delovi Parts list Stuckliste 5746.20.00	30	K22	485  RØ36	



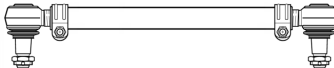
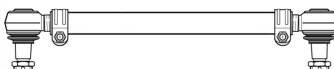

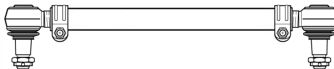
Originalni broj Cross-Ref.No. Original Nr.	Br. FAD No. Nr.	Naziv Designation Bezeichnung	Kugla Ball Ø Größe	Konus Taper Konus	Dužina Length Länge	Skica Figure Bild
<b>668 460 05 05</b> 668 460 07 05 668 460 09 05 668 460 11 05	<b>3916.00.00</b>	Spona upravljača Drag link Lenkstange Izmenljivi delovi Parts list Stuckliste 5809.20.00	30	K18	505  RØ30	
<b>668 460 15 05</b> 668 460 17 05 668 460 19 05	<b>3917.00.00</b>	Spona upravljača Drag link Lenkstange Izmenljivi delovi Parts list Stuckliste 5809.20.00	30	K18	505  RØ30	
<b>668 460 21 05</b> 668 460 22 05	<b>4535.00.00</b>	Spona upravljača Drag link Lenkstange Izmenljivi delovi Parts list Stuckliste 5798.20.00	25	K18	495  RØ30	
<b>669 330 04 03</b> 669 330 05 03 670 330 00 03 670 330 01 03 670 330 02 03 670 330 03 03	<b>5828.00.00</b>	Poprečna spona Tie rod Spurstange Izmenljivi delovi Parts list Stuckliste 4746.10.00 4746.20.00	30	K22	1594  RØ40	
<b>670 460 08 05</b> 670 460 12 05 670 460 16 05 670 460 20 05	<b>5365.00.00</b>	Spona upravljača Drag link Lenkstange  Izmenljivi delovi Parts list Stuckliste 5746.20.00	30	K22	505  RØ36	
<b>670 460 26 05</b> 670 460 27 05	<b>5363.00.00</b>	Spona upravljača Drag link Lenkstange  Izmenljivi delovi Parts list Stuckliste 5746.20.00	30	K22	495  RØ36	

Originalni broj Cross-Ref.No. Original Nr.	Br. FAD No. Nr.	Naziv Designation Bezeichnung	Kugla Ball Ø Größe	Konus Taper Konus	Dužina Length Länge	Skica Figure Bild
<b>671 333 01 05</b>	<b>6904.00.00</b>	Vođica mosta Torque rod Achsstrebe Izmenljivi delovi Parts list Stuckliste 5323.90.00	62	Ø17 >24< <115>	640  RØ50	
<b>671 460 02 05</b>	<b>6900.00.00</b>	Spona upravljača Drag link Lenkstange Izmenljivi delovi Parts list Stuckliste 5743.10.00 5743.20.00	40	K30	1140  RØ40	
<b>673 460 02 05</b> 673 460 04 05 673 460 06 05 673 460 08 05	<b>5888.00.00</b>	Spona upravljača Drag link Lenkstange Izmenljivi delovi Parts list Stuckliste 5748.20.00	35	K22	725  RØ36	
<b>673 460 03 05</b> 673 460 05 05 673 460 07 05 673 460 09 05	<b>5831.00.00</b>	Spona upravljača Drag link Lenkstange  Izmenljivi delovi Parts list Stuckliste 5748.20.00	35	K22	725  RØ36	
<b>675 460 10 05</b> 675 460 16 05 675 460 22 05 675 460 28 05	<b>3306.00.00</b>	Spona upravljača Drag link Lenkstange  Izmenljivi delovi Parts list Stuckliste 5742.20.00	40/30	K26/ K22	750  RØ40	
<b>675 460 12 05</b> 675 460 18 05 675 460 24 05 675 460 30 05	<b>3972.00.00</b>	Spona upravljača Drag link Lenkstange  Izmenljivi delovi Parts list Stuckliste 5742.20.00	40/30	K26/ K22	727  RØ40	

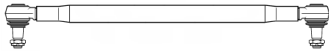
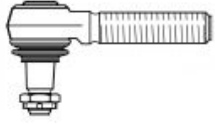
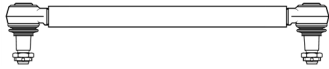
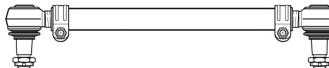
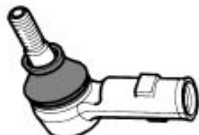
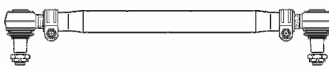



Originalni broj Cross-Ref.-No. Original Nr.	Br. FAD No. Nr.	Naziv Designation Bezeichnung	Kugla Ball Ø Größe	Konus Taper Konus	Dužina Length Länge	Skica Figure Bild
<b>675 460 13 05</b> 675 460 19 05 675 460 25 05 675 460 31 05	<b>5631.00.00</b>	Spona upravljača Drag link Lenkstange Izmenljivi delovi Parts list Stuckliste 5742.20.00	40/30	K26/ K22	709  RØ40	
<b>676 330 02 03</b> 676 330 04 03 676 330 07 03 676 330 09 03	<b>5829.00.00</b>	Poprečna spona Tie rod Spurstange Izmenljivi delovi Parts list Stuckliste 4746.10.00 4746.20.00	30	K22	1550  RØ40	
<b>676 330 08 03</b> 676 330 10 03	<b>5863.00.00</b>	Poprečna spona Tie rod Spurstange Izmenljivi delovi Parts list Stuckliste 5741.10.00 5741.20.00	35	K26	1546  RØ46	
<b>676 460 01 05</b> 676 460 06 05 676 460 11 05 676 460 15 05	<b>3307.00.00</b>	Spona upravljača Drag link Lenkstange Izmenljivi delovi Parts list Stuckliste 5742.20.00	40/30	K26	780  RØ42	
<b>676 460 12 05</b> 676 460 16 05	<b>4564.00.00</b>	Spona upravljača Drag link Lenkstange Izmenljivi delovi Parts list Stuckliste 5742.20.00	40/30	K26	780  RØ40	
<b>677 330 03 03</b> 677 330 04 03	<b>5866.00.00</b>	Poprečna spona Tie rod Spurstange Izmenljivi delovi Parts list Stuckliste 5741.10.00 5741.20.00	35	K26	1562  RØ46	

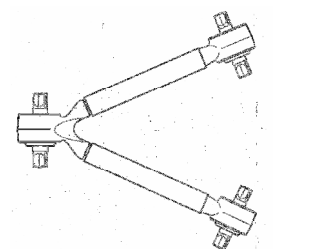

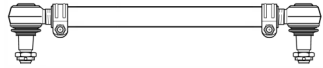

Originalni broj Cross-Ref.-No. Original Nr.	Br. FAD No. Nr.	Naziv Designation Bezeichnung	Kugla Ball Ø Größe	Konus Taper Konus	Dužina Length Länge	Skica Figure Bild
<b>699 460 05 05</b>	<b>6927.00.00</b>	Spona upravljača Drag link Lenkstange	40	K30	1905 RØ50	
<b>699 460 16 48</b>	<b>5536.20.00</b>	Zglob,RH M30x1.5 Ball joint, RH Kugelgelenk, RH	40	K30	155	
<b>699 460 42 05</b>	<b>6925.00.00</b>	Spona upravljača Drag link Lenkstange	40	K30	1383 RØ40	
<b>699 460 84 05</b> 699 460 98 05	<b>6926.00.00</b>	Spona upravljača Drag link Lenkstange  Izmenljivi delovi Parts list Stuckliste 6321.10.00 4563 20 00	40	K30	860 RØ40	
<b>901 460 01 48</b> 901 460 03 48	<b>1711.20.00</b>	Zglob,RH M16x1.5 * Ball joint, RH Kugelgelenk, RH	25	K20	80	
<b>941 330 00 03</b> 941 330 01 03 941 330 02 03 941 330 03 03	<b>4450.00.00</b>	Poprečna spona Tie rod Spurstange  Izmenljivi delovi Parts list Stuckliste 5855.10.00 5855.20.00	40	K32	1735 RØ52	



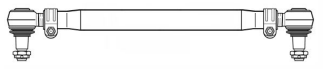
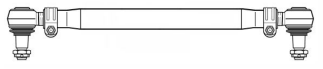

Originalni broj Cross-Ref.-No. Original Nr.	Br. FAD No. Nr.	Naziv Designation Bezeichnung	Kugla Ball Ø Größe	Konus Taper Konus	Dužina Length Länge	Skica Figure Bild
<b>941 330 00 07</b>	<b>3303.00.00</b>	Vođica mosta Torque rod Achsstrebe Izmenljivi delovi Parts list Stuckliste 3935.96.00	55	Ø17 >20< <100>	847  RØ60	
<b>942 330 00 03</b> 942 330 01 03 942 330 02 03 942 330 07 03 942 330 11 03	<b>4496.00.00</b>	Poprečna spona Tie rod Spurstange  Izmenljivi delovi Parts list Stuckliste 5855.20.00	40	K32	1734  RØ52	
<b>942 330 03 03</b> 942 330 04 03 942 330 16 03	<b>4457.00.00</b>	Poprečna spona Tie rod Spurstange  Izmenljivi delovi Parts list Stuckliste 5855.10.00 5855.20.00	40	K32	1644  RØ50	
<b>942 330 08 03</b> 949 330 02 03 949 330 03 03 949 330 09 03	<b>4459.00.00</b>	Poprečna spona Tie rod Spurstange  Izmenljivi delovi Parts list Stuckliste 5855.10.00 5855.20.00	40	K32	1625  RØ50	
<b>942 350 05 05</b> 942 350 08 05	<b>4538.00.00</b>	V-Vođica mosta Triangular torque rod Dreieckslenker  Izmenljivi delovi Parts list Stuckliste 4538.90.00 4483.96.00	72.5	Ø25/ Ø23 >24< <152>/ <130>	622  RØ50	

Originalni broj Cross-Ref.-No. Original Nr.	Br. FAD No. Nr.	Naziv Designation Bezeichnung	Kugla Ball Ø Größe	Konus Taper Konus	Dužina Length Länge	Skica Figure Bild
<b>942 350 10 05</b> 944 350 00 05 947 350 01 05 947 350 10 05	<b>4480.00.00</b>	V-Vođica mosta Triangular torque rod Dreieckslenker  Izmenljivi delovi Parts list 4482.96.00 4483.96.00	70/ 62.5	Ø25 >24< <152>/ <130>	622  RØ50	
<b>944 350 03 05</b> 944 350 05 05 944 350 06 05 947 350 09 05 948 350 04 05 948 350 30 05	<b>4481.00.00</b>	V-Vođica mosta Triangular torque rod Dreieckslenker  Izmenljivi delovi Parts list 4482.96.00 4484.96.00	83/ 62.5	Ø25 >24< <152>/ <130>	622  RØ50	
<b>945 330 00 03</b> 945 330 01 03 945 330 04 03 945 330 06 03	<b>4553.00.00</b>	Poprečna spona Tie rod Spurstange  Izmenljivi delovi Parts list Stuckliste 5079.20.00	40	K32	1735  RØ62	
<b>945 330 00 07</b>	<b>3301.00.00</b>	Vođica mosta Torque rod Achsstrebe  Izmenljivi delovi Parts list Stuckliste 3935.96.00	55	Ø17 >20< <100>	825  RØ62	
<b>945 330 00 11</b> SA 508 316/02	<b>3304.00.00</b>	Vođica mosta Torque rod Achsstrebe  Izmenljivi delovi Parts list 3935.96.00	55	Ø17 >20< <100>	755  RØ60	

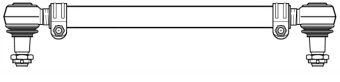
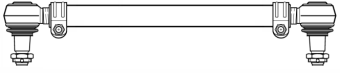
Originalni broj Cross-Ref.-No. Original Nr.	Br. FAD No. Nr.	Naziv Designation Bezeichnung	Kugla Ball Ø Größe	Konus Taper Konus	Dužina Length Länge	Skica Figure Bild
<b>945 330 02 03</b> 945 330 03 03 945 330 05 03	<b>4451.00.00</b>	Poprečna spona Tie rod Spurstange Izmenljivi delovi Parts list Stuckliste 5855.10.00 5855.20.00	40	K32	1465  RØ40	
<b>945 350 01 05</b> 948 350 25 05	<b>6407.00.00</b>	Vođica mosta Torque rod Achsstrebe Izmenljivi delovi Parts list Stuckliste 3765.96.00	78.5	Ø21 >24< <152>	615  RØ58	
<b>947 350 00 05</b> 948 350 06 05 948 350 12 05 948 350 13 05	<b>3979.00.00</b>	Vođica mosta Torque rod Achsstrebe Izmenljivi delovi Parts list Stuckliste 3765.96.00	50	Ø21 >24< <152>	565  RØ50	
<b>949 330 04 03</b> 949 330 05 03 949 330 08 03 949 330 14 03	<b>4559.00.00</b>	Poprečna spona Tie rod Spurstange Izmenljivi delovi Parts list Stuckliste 5855.20.00	40	K32	1700  RØ52	
<b>949 330 10 03</b> 949 330 11 03 949 330 17 03	<b>4522.00.00</b>	Poprečna spona Tie rod Spurstange Izmenljivi delovi Parts list Stuckliste 5855.10.00 5855.20.00	40	K32	1596  RØ50	
<b>949 330 12 03</b> 949 330 13 03 949 330 18 03	<b>4511.00.00</b>	Poprečna spona Tie rod Spurstange Izmenljivi delovi Parts list Stuckliste 5855.10.00 5855.20.00	40	K32	1532  RØ50	

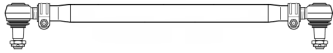

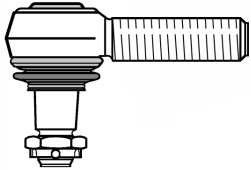
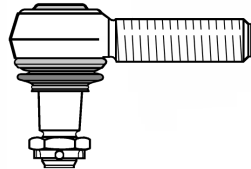

Originalni broj Cross-Ref.-No. Original Nr.	Br. FAD No. Nr.	Naziv Designation Bezeichnung	Kugla Ball Ø Größe	Konus Taper Konus	Dužina Length Länge	Skica Figure Bild
<b>957 460 05 05</b> 957 460 07 05	<b>4579.00.00</b>	Poprečna spona Tie rod Spurstange Izmenljivi delovi Parts list Stuckliste 5855.10.00	40	K32	880  RØ50	
<b>970 330 00 03</b> 970 330 01 03 970 330 02 03 970 330 03 03 970 330 04 03	<b>4471.00.00</b>	Poprečna spona Tie rod Spurstange Izmenljivi delovi Parts list Stuckliste 5741.10.00 5741.20.00	35	K26	1640  RØ40	
<b>970 460 07 05</b> 970 460 09 05	<b>4514.00.00</b>	Spona upravljača Drag link Lenkstange Izmenljivi delovi Parts list Stuckliste 5741.20.00	35	K26	846  RØ42	
<b>970 460 08 05</b> 970 460 10 05	<b>4562.00.00</b>	Spona upravljača Drag link Lenkstange Izmenljivi delovi Parts list Stuckliste 5741.20.00	35	K26	846  RØ42	
<b>972 460 14 05</b> 972 460 16 05	<b>4532.00.00</b>	Spona upravljača Drag link Lenkstange Izmenljivi delovi Parts list Stuckliste 5741.20.00	35	K26	837  RØ40	
<b>972 460 15 05</b> 972 460 17 05	<b>4561.00.00</b>	Spona upravljača Drag link Lenkstange Izmenljivi delovi Parts list Stuckliste 5741.20.00	35	K26	837  RØ40	

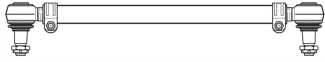
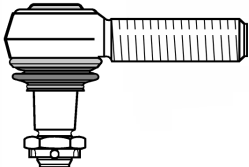
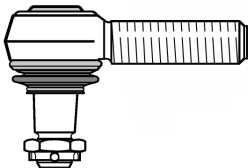
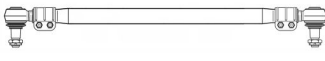
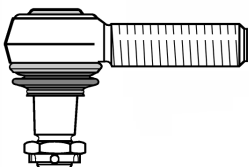
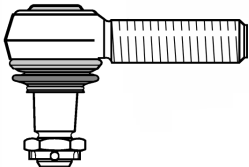
Originalni broj Cross-Ref.-No. Original Nr.	Br. FAD No. Nr.	Naziv Designation Bezeichnung	Kugla Ball Ø Größe	Konus Taper Konus	Dužina Length Länge	Skica Figure Bild
<b>972 460 18 05</b> 972 460 20 05	<b>4513.00.00</b>	Spona upravljača Drag link Lenkstange Izmenljivi delovi Parts list Stuckliste 5743.20.00	40	K30	871 RØ50	
<b>974 460 10 05</b> 974 460 12 05	<b>4524.00.00</b>	Spona upravljača Drag link Lenkstange Izmenljivi delovi Parts list Stuckliste 5743.20.00	40	K30	876 RØ50	
<b>974 460 11 05</b> 974 460 13 05	<b>4565.00.00</b>	Spona upravljača Drag link Lenkstange Izmenljivi delovi Parts list Stuckliste 5743.20.00	40	K30	894 RØ50	
<b>975 330 02 03</b> 975 330 03 03 975 330 08 03	<b>4474.00.00</b>	Poprečna spona Tie rod Spurstange  Izmenljivi delovi Parts list Stuckliste 5743.10.00 5743.20.00	40	K30	1607 RØ40	
<b>975 330 06 03</b> 975 330 07 03 975 330 09 03	<b>6917.00.00</b>	Poprečna spona Tie rod Spurstange  Izmenljivi delovi Parts list Stuckliste 6321.10.00 4563.20.00	40	K30	1560 RØ40	



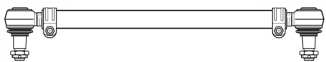

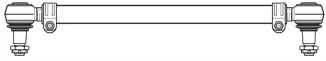
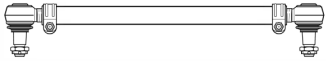
Originalni broj Cross-Ref.-No. Original Nr.	Br. FAD No. Nr.	Naziv Designation Bezeichnung	Kugla Ball Ø Größe	Konus Taper Konus	Dužina Length Länge	Skica Figure Bild
<b>143 929</b>	<b>4440.00.00</b>	Poprečna spona Tie rod Spurstange  Izmenjivi delovi Parts list Stuckliste 5743.10.00 5743.20.00	40	K30	1804  RØ52	
<b>144 228</b>	<b>4441.00.00</b>	Poprečna spona Tie rod Spurstange  Izmenjivi delovi Parts list Stuckliste 5743.10.00 5743.20.00	40	K30	1654  RØ52	
<b>377 740</b>	<b>5928.00.00</b>	Spona upravljača Drag link Lenkstange  Izmenjivi delovi Parts list Stuckliste 5743.20.00	40	K30	857  RØ40	
<b>4922-02/1962</b> 91842	<b>4345.00.00</b>	Poprečna spona Tie rod Spurstange  Izmenjivi delovi Parts list Stuckliste 5743.10.00 5743.20.00	40	K30	1537  RØ50	
<b>619 687</b>	<b>7720.20.00</b>	Zglob, RH M30x1,5 Ball joint, RH Kugelgelenk, RH	40	K31.5	120	
<b>654 136</b>	<b>5746.10.00</b>	Zglob, LH M28x1,5 Ball joint, LH Kugelgelenk, LH	30	K22	105	

Originalni broj Cross-Ref.-No. Original Nr.	Br. FAD No. Nr.	Naziv Designation Bezeichnung	Kugla Ball Ø Größe	Konus Taper Konus	Dužina Length Länge	Skica Figure Bild
<b>660 856</b>	<b>3582.00.00</b>	Poprečna spona Tie rod Spurstange  Izmenjivi delovi Parts list Stuckliste 5743.10.00 5743.20.00	40	K30	1550  RØ42	
<b>660 857</b>	<b>5743.10.00</b>	Zglob, LH M30x1,5 Ball joint, LH Kugelgelenk, LH	40	K30	120	
<b>660 858</b>	<b>5743.20.00</b>	Zglob, RH M30x1,5 Ball joint, RH Kugelgelenk, RH	40	K30	120	
<b>660 915</b>	<b>3581.00.00</b>	Poprečna spona Tie rod Spurstange  Izmenjivi delovi Parts list Stuckliste 3581.10.00 3581.20.00	50	K38	1485  RØ50	
<b>660 916</b>	<b>3581.10.00</b>	Zglob, LH M38x1,5 Ball joint, LH Kugelgelenk, LH	50	K38	135	
<b>660 917</b>	<b>3581.20.00</b>	Zglob, RH M38x1,5 Ball joint, RH Kugelgelenk, RH	50	K38	135	

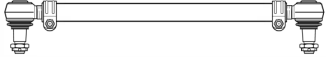
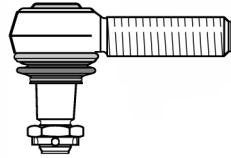
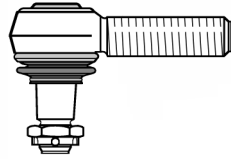
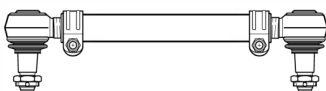
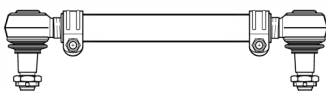
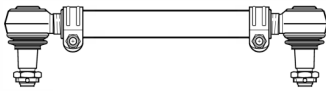

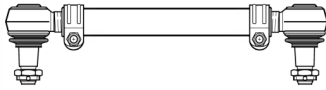
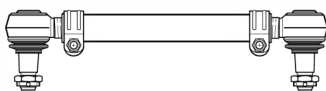
Originalni broj Cross-Ref.-No. Original Nr.	Br. FAD No. Nr.	Naziv Designation Bezeichnung	Kugla Ball Ø Größe	Konus Taper Konus	Dužina Length Länge	Skica Figure Bild
<b>660 976</b>	<b>3586.00.00</b>	Poprečna spona Tie rod Spurstange  Izmenjivi delovi Parts list Stuckliste 5741.10.00 5741.20.00	35	K26	1690  RØ40	
<b>660 977</b>	<b>3584.00.00</b>	Poprečna spona Tie rod Spurstange  Izmenjivi delovi Parts list Stuckliste 5743.10.00 5743.20.00	40	K30	1645  RØ42	
<b>665 178</b>	<b>3587.00.00</b>	Poprečna spona Tie rod Spurstange  Izmenjivi delovi Parts list Stuckliste 5746.10.00 5746.20.00	30	K22	1460  RØ36	
<b>665 196</b>	<b>3579.00.00</b>	Poprečna spona Tie rod Spurstange  Izmenjivi delovi Parts list Stuckliste 3585.10.00 3585.20.00	40	K31.5	1669  RØ52	
<b>665 197</b>	<b>3573.00.00</b>	Poprečna spona Tie rod Spurstange  Izmenjivi delovi Parts list Stuckliste 3585.20.00	40	K31.5	1590  RØ52	

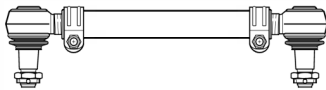
Originalni broj Cross-Ref.-No. Original Nr.	Br. FAD No. Nr.	Naziv Designation Bezeichnung	Kugla Ball Ø Größe	Konus Taper Konus	Dužina Length Länge	Skica Figure Bild
<b>678 612</b>	<b>3576.00.00</b>	Poprečna spona Tie rod Spurstange  Izmenjivi delovi Parts list Stuckliste 5743.10.00 5743.20.00	40	K30	1530  RØ42	
<b>678 621</b>	<b>5741.10.00</b>	Zglob, LH M30x1,5 Ball joint, LH Kugelgelenk, LH	35	K26	115	
<b>678 622</b>	<b>5741.20.00</b>	Zglob, RH M30x1,5 Ball joint, RH Kugelgelenk, RH	35	K26	115	
<b>683 795</b>	<b>3595.00.00</b>	Poprečna spona Tie rod Spurstange  Izmenjivi delovi Parts list Stuckliste 3581.10.00 3582.20.00	50	K38	1706  RØ50	
<b>685 201</b>	<b>3593.00.00</b>	Poprečna spona Tie rod Spurstange Izmenjivi delovi Parts list Stuckliste 5743.10.00 5743.20.00	40	K30	1655  RØ42	
<b>699 432</b>	<b>3597.00.00</b>	Poprečna spona Tie rod Spurstange Izmenjivi delovi Parts list Stuckliste 5743.10.00 5743.20.00	40	K30	1760  RØ42	

Originalni broj Cross-Ref.-No. Original Nr.	Br. FAD No. Nr.	Naziv Designation Bezeichnung	Kugla Ball Ø Größe	Konus Taper Konus	Dužina Length Länge	Skica Figure Bild
<b>700 875</b>	<b>3598.00.00</b>	Poprečna spona Tie rod Spurstange  Izmenjivi delovi Parts list Stuckliste 5741.10.00 5741.20.00	35	K26	1550  RØ40	
<b>737 710</b>	<b>3599.00.00</b>	Poprečna spona Tie rod Spurstange  Izmenjivi delovi Parts list Stuckliste 3581.10.00 3581.20.00	50	K38	1590  RØ50	
<b>783.24-3143-000</b> 86397	<b>4337.00.00</b>	Poprečna spona Tie rod Spurstange  Izmenjivi delovi Parts list Stuckliste 3581.10.00 3581.20.00	50	K38	1496  RØ52	
<b>832.00.3183.000</b>	<b>5198.00.00</b>	Poprečna spona Tie rod Spurstange  Izmenjivi delovi Parts list Stuckliste 5743.10.00 5743.20.00	40	K30	1654  RØ50	
<b>836.01.3504.000</b>	<b>5914.00.00</b>	Spona upravljača Drag link Lenkstange  Izmenjivi delovi Parts list Stuckliste 5743.20.00	40	K30	857  RØ40	

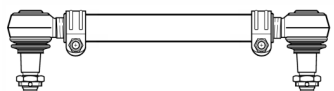
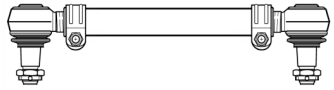
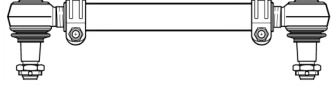
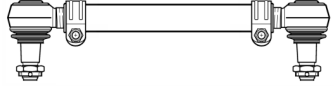
Originalni broj Cross-Ref.-No. Original Nr.	Br. FAD No. Nr.	Naziv Designation Bezeichnung	Kugla Ball Ø Größe	Konus Taper Konus	Dužina Length Länge	Skica Figure Bild
<b>839.53.3143.000</b> 83757	<b>4333.00.00</b>	Poprečna spona Tie rod Spurstange  Izmenjivi delovi Parts list Stuckliste 5743.10.00 5743.20.00	40	K30	1514  RØ50	
<b>832.45</b>	<b>3583.00.00</b>	Poprečna spona Tie rod Spurstange  Izmenjivi delovi Parts list Stuckliste 3583.10.00 3583.20.00	40	K30	1645  RØ42	
<b>900.20/21</b>	<b>3585.00.00</b>	Poprečna spona Tie rod Spurstange  Izmenjivi delovi Parts list Stuckliste 3585.10.00 3585.20.00	40	K31.5	1530 RØ42	
<b>900.81</b>	<b>3588.00.00</b>	Poprečna spona Tie rod Spurstange  Izmenjivi delovi Parts list Stuckliste 3585.10.00 3585.20.00	40	K31.5	1600 RØ42	
<b>91720</b>	<b>3646.00.00</b>	Poprečna spona Tie rod Spurstange  Izmenjivi delovi Parts list Stuckliste 5743.10.00 5743.20.00	40	K30	1504 RØ42	

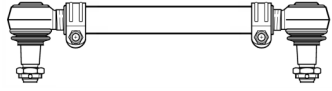
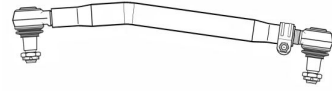
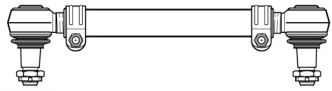
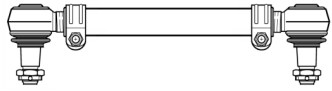
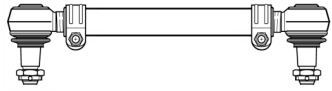
Originalni broj Cross-Ref.-No. Original Nr.	Br. FAD No. Nr.	Naziv Designation Bezeichnung	Kugla Ball Ø Größe	Konus Taper Konus	Dužina Length Länge	Skica Figure Bild
<b>99656</b>	<b>4387.00.00</b>	Poprečna spona Tie rod Spurstange  Izmenjivi delovi Parts list Stuckliste 5746.10.00 5746.20.00	30	K22	1703.5  RØ36	
<b>997 324</b>	<b>5927.00.00</b>	Spona upravljača Drag link Lenkstange  Izmenjivi delovi Parts list Stuckliste 5743.20.00	40	K30	857  RØ40	
<b>A4815-20</b>	<b>4334.00.00</b>	Spona upravljača Drag link Lenkstange  Izmenjivi delovi Parts list Stucklist 5746.10.00 5746.20.00	30	K22	503  RØ40	
<b>A4815-21</b>	<b>4335.00.00</b>	Spona upravljača Drag link Lenkstange  Izmenjivi delovi Parts list Stuckliste 5746.10.00 5746.20.00	30	K22	355  RØ40	
<b>A4815-22</b>	<b>4336.00.00</b>	Spona upravljača Drag link Lenkstange  Izmenjivi delovi Parts list Stuckliste 5746.10.00 5746.20.00	30	K22	980  RØ40	

Originalni broj Cross-Ref.-No. Original Nr.	Br. FAD No. Nr.	Naziv Designation Bezeichnung	Kugla Ball Ø Größe	Konus Taper Konus	Dužina Length Länge	Skica Figure Bild
<b>00 00 566 157</b>	<b>5980.00.00</b>	Vođica mosta Torque rod Achsstrebe  Izmenjivi delovi Parts list Stuckliste 5980.90.00 5981.90.00	65	Ø32 K45	510  RØ50	
<b>00 00 691 970</b>	<b>3283.00.00</b>	Vođica mosta Torque rod Achsstrebe  Izmenjivi delovi Parts list Stuckliste 5506.96.00	55	Ø25	620  RØ50	
<b>00 00 745 019</b>	<b>5981.00.00</b>	Vođica mosta Torque rod Achsstrebe  Izmenjivi delovi Parts list Stuckliste 5981.90.00 5982.90.00	65	K45 Ø19 >30< <145>	475  RØ50	
<b>00 03 401 149</b> 50 00 803 461	<b>5998.20.00</b>	Zglob, RH M22x1.5 Ball joint, RH Kugelgelenk, RH	30	K20	95	
<b>00 03 401 150</b> 50 00 803 462	<b>5998.10.00</b>	Zglob, LH M22x1.5 Ball joint, LH Kugelgelenk, LH	30	K20	95	
<b>00 03 401 170</b> 50 00 288 361 50 01 832 581	<b>5743.10.00</b>	Zglob, LH M30x1.5 Ball joint, LH Kugelgelenk, LH	40	K30	120	

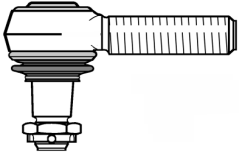
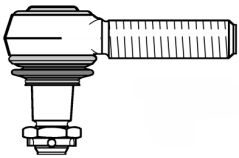
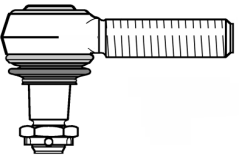
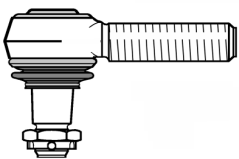
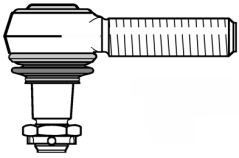
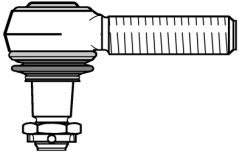
Originalni broj Cross-Ref.-No. Original Nr.	Br. FAD No. Nr.	Naziv Designation Bezeichnung	Kugla Ball Ø Größe	Konus Taper Konus	Dužina Length Länge	Skica Figure Bild
<b>00 03 401 206</b> 50 01 832 579	<b>5856.10.00</b>	Zglob, LH M38x1.5 Ball joint, LH Kugelgelenk, LH	40	K30	120	
<b>00 03 401 207</b> 50 01 831 481 50 01 832 580	<b>5856.20.00</b>	Zglob, RH M38x1.5 Ball joint, RH Kugelgelenk, RH	40	K30	120	
<b>00 03 406 169</b> 00 03 406 236 00 03 406 251 00 03 406 254 00 03 406 260 00 03 406 261 50 00 288 360 50 00 590 236 50 00 804 824 77 01 011 412	<b>5743.20.00</b>	Zglob, RH M30x1.5 Ball joint, RH Kugelgelenk, RH	40	K30	120	
<b>00 03 406 212</b> 00 03 406 253 50 00 242 159 50 00 295 214 50 00 812 483 50 01 850 549 77 01 016 946	<b>5741.20.00</b>	Zglob, RH M30x1.5 Ball joint, RH Kugelgelenk, RH	35	K26	115	
<b>00 03 406 213</b> 00 03 406 218 50 00 295 215 50 01 850 550 50 01 852 263	<b>5741.10.00</b>	Zglob, LH M30x1.5 Ball joint, LH Kugelgelenk, LH	35	K26	115	
<b>00 03 406 252</b> 50 00 807 554 50 00 814 097 50 01 844 136	<b>5805.20.00</b>	Zglob, RH M24x1.5 Ball joint, RH Kugelgelenk, RH	30	K20	95	

Originalni broj Cross-Ref.-No. Original Nr.	Br. FAD No. Nr.	Naziv Designation Bezeichnung	Kugla Ball Ø Größe	Konus Taper Konus	Dužina Length Länge	Skica Figure Bild
<b>00 23 123 159</b>	<b>5987.00.00</b>	Vodica mosta Torque rod Achsstrebe Izmenjivi delovi Parts list Stuckliste 5980.90.00	65	Ø32	507 RØ52	
<b>00 23 123 220</b> 1 151 394	<b>3289.00.00</b>	Vodica mosta Torque rod Achsstrebe Izmenjivi delovi Parts list Stuckliste 5755.96.00	70	Ø19 >30< <145>	560 RØ50	
<b>00 23 123 225</b> 00 23 123 240 50 01 826 368	<b>5760.00.00</b>	Poprečna spona Tie rod Spurstange Izmenjivi delovi Parts list Stuckliste 5743.20.00	40	K30	1470 RØ50	
<b>00 23 123 233</b>	<b>5996.00.00</b>	Spona upravljača Drag link Lenkstange Izmenjivi delovi Parts list Stuckliste 5743.20.00	40	K30	1835 RØ40	
<b>00 23 123 237</b> 1 151 395	<b>5755.00.00</b>	Vodica mosta Torque rod Achsstrebe Izmenjivi delovi Parts list Stuckliste 5755.96.00	70	Ø19 >30< <145>	535 RØ50	
<b>00 23 123 238</b> 1 151 396	<b>5757.00.00</b>	Vodica mosta Torque rod Achsstrebe Izmenjivi delovi Parts list Stuckliste 5755.96.00	70	Ø19 >30< <145>	535 RØ50	



Originalni broj Cross-Ref.-No. Original Nr.	Br. FAD No. No. Nr.	Naziv Designation Bezeichnung	Kugla Ball Ø Größe	Konus Taper Konus	Dužina Length Länge	Skica Figure Bild
<b>00 23 123 247</b> 50 00 748 868 50 00 874 577 50 10 130 453	<b>3298.00.00</b>	Spona upravljača Drag link Lenkstange Izmenjivi delovi Parts list Stuckliste 5743.20.00	40	K30	1000  RØ52	
<b>00 23 123 252</b> 50 00 788 392	<b>5983.00.00</b>	Vođica mosta Torque rod Achsstrebe  Izmenjivi delovi Parts list Stuckliste 5982.90.00 5983.90.00	65	Ø19 >30< <145>	467 RØ50	
<b>00 23 123 253</b> 50 00 750 976 50 00 783 574 50 01 850 530 50 10 064 641 50 10 094 838 50 10 094 941	<b>5985.00.00</b>	Vođica mosta Torque rod Achsstrebe  Izmenjivi delovi Parts list Stuckliste 5982.90.00	65	Ø19 >30< <145>	575 RØ52	
<b>00 23 123 253</b> 50 00 750 976 50 00 783 574 50 01 850 530 50 10 064 641 50 10 094 838 50 10 094 941	<b>5982.00.00</b>	Vođica mosta Torque rod Achsstrebe  Izmenjivi delovi Parts list Stuckliste 5982.90.00	65	Ø19 >30< <145>	575 RØ50	
<b>00 23 123 262</b>	<b>4661.00.00</b>	Spona upravljača Drag link Lenkstange  Izmenjivi delovi Parts list Stuckliste 3307.20.00	50	K30	505 RØ50	

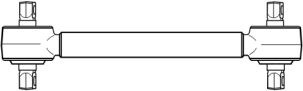
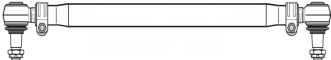
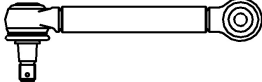
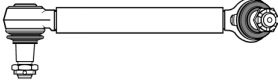
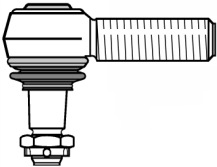

Originalni broj Cross-Ref.-No. Original Nr.	Br. FAD No. Nr.	Naziv Designation Bezeichnung	Kugla Ball Ø Größe	Konus Taper Konus	Dužina Length Länge	Skica Figure Bild
<b>00 23 123 265</b>	<b>5759.00.00</b>	Spona upravljača Drag link Lenkstange  Izmenjivi delovi Parts list Stuckliste 5743.20.00	40	K30	797  RØ52	
<b>00 23 123 275</b>	<b>5993.00.00</b>	Vođica mosta Torque rod Achsstrebe  Izmenjivi delovi Parts list Stuckliste 5755.96.00	70	Ø19 >30< <145>	535  RØ50	
<b>00 23 162 046</b> 50 00 516 214 50 10 144 543	<b>3590.20.00</b>	Zglob, RH 14x1.5 Ball joint, RH Kugelgelenk, RH	22	K12	85	
<b>20 847 191</b> 7420 847 190	<b>4711.00.00</b>	Spona upravljača Drag link Lenkstange  Izmenjivi delovi Parts list Stuckliste 4711.20.00	40	K30	915  RØ60	
<b>23 123 224</b> 50 10 145 077	<b>4666.00.00</b>	Poprečna spona Tie rod Spurstange  Izmenjivi delovi Parts list Stuckliste 5856.10.00 5856.20.00	40	K30	1700  RØ50	
<b>23 123 256</b>	<b>5995.00.00</b>	Vođica mosta Torque rod Achsstrebe Izmenjivi delovi Parts list Stuckliste 5982.90.00	65	Ø19 >30< <145>	560  RØ50	

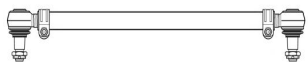
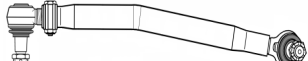
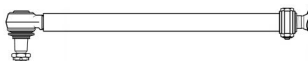
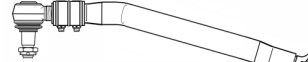
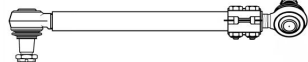
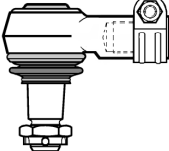

Originalni broj Cross-Ref.-No. Original Nr.	Br. FAD No. Nr.	Naziv Designation Bezeichnung	Kugla Ball Ø Größe	Konus Taper Konus	Dužina Length Länge	Skica Figure Bild
<b>25 379 292</b> 50 01 868 383 50 10 630 820 50 10 630 821	<b>4693.00.00</b>	Spona upravljača Drag link Lenkstange  Izmenjivi delovi Parts list Stuckliste 4706.20.00	40	K30	880  RØ62	
<b>50 00 027 957</b> 50 00 810 038	<b>5910.00.00</b>	Vođica mosta Torque rod Achsstrebe Izmenjivi delovi Parts list Stuckliste 5170.96.00	70	Ø19 >30<	565  RØ50	
<b>50 00 145 581</b> 50 00 791 032 50 10 308 215 50 10 791 275	<b>4673.00.00</b>	Spona upravljača Drag link Lenkstange Izmenjivi delovi Parts list Stuckliste 5743.10.00 5743.20.00	40	K30	1650  RØ50	
<b>50 00 450 713</b>	<b>4703.00.00</b>	Stabilizator Stabillizer link Koppelstang	30	K20	335  RØ30	
<b>50 00 450 714</b>	<b>4704.00.00</b>	Stabilizator Stabillizer link Koppelstang	30	K20	335  RØ30	
<b>50 00 559 336</b> 50 00 823 947 50 00 823 997	<b>5746.10.00</b>	Zglob,LH M28x1.5 Ball joint, LH Kugelgelenk, LH	30	K22	105	

Originalni broj Cross-Ref.-No. Original Nr.	Br. FAD No. Nr.	Naziv Designation Bezeichnung	Kugla Ball Ø Größe	Konus Taper Konus	Dužina Length Länge	Skica Figure Bild
<b>50 00 613 837</b>	<b>4679.00.00</b>	Poprečna spona Tie rod Spurstange Izmenjivi delovi Parts list Stuckliste 5741.10.00 5741.20.00	35	K26	1510  RØ40	
<b>50 00 725 267</b> 50 10 144 549 50 10 144 552	<b>3296.00.00</b>	Spona upravljača Drag link Lenkstange Izmenjivi delovi Parts list Stuckliste 5743.20.00	40	K30	975  RØ52	
<b>50 00 761 671</b> 50 10 151 528 50 10 207 724	<b>4731.00.00</b>	Spona upravljača Drag link Lenkstange Izmenjivi delovi Parts list Stuckliste 4563.20.00	40	K30	1475  RØ40	
<b>50 00 785 429</b>	<b>3292.00.00</b>	Spona upravljača Drag link Lenkstange Izmenjivi delovi Parts list Stuckliste 5743.20.00	40	K30	915  RØ52	
<b>50 00 786 532</b>	<b>4660.00.00</b>	Spona upravljača Drag link Lenkstange Izmenjivi delovi Parts list Stuckliste 5743.20.00	40	K30	485  RØ40	
<b>50 00 792 132</b>	<b>7474.20.00</b>	Zglob, RH 24x1.5* Ball joint, RH Kugelgelenk, RH	40	K30	95	

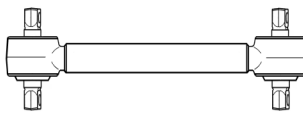
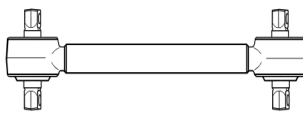
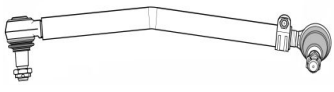
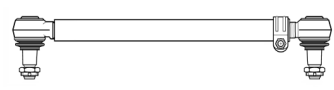
Originalni broj Cross-Ref.-No. Original Nr.	Br. FAD No. No.	Naziv Designation Bezeichnung	Kugla Ball Ø Größe	Konus Taper Konus	Dužina Length Länge	Skica Figure Bild
<b>50 00 802 123</b>	<b>5755.96.00</b>	Izmenjivi podsklop Repair kit Reparatur satz	70	Ø19 >30<	<145>	
<b>50 00 807 553</b> 50 00 814 096 50 01 844 135	<b>5805.10.00</b>	Zglob, LH 24x1.5 Ball joint, LH Kugelgelenk, LH	30	K20	95	
<b>50 00 808 458</b> 77 01 002 911	<b>5742.20.00</b>	Zglob, RH 30x1.5 Ball joint, RH Kugelgelenk, RH	40	K26	120	
<b>50 00 814 841</b>	<b>3284.96.00</b>	Izmenjivi podsklop Repair kit Reparatur satz	55	Ø15 >24<	<100>	
<b>50 00 819 365</b> 50 10 104 465	<b>5992.96.00</b>	Izmenjivi podsklop Repair kit Reparatur satz	62	Ø17 >24<	<122>	
<b>50 01 014 520</b>	<b>5524.90.00</b>	Izmenjivi podsklop Repair kit Reparatur satz	65	K38		
<b>50 01 823 718</b>	<b>4163.20.00</b>	Zglob, RH M30x1,5 * Ball joint, RH Kugelgelenk, RH	50	K38	86	
<b>50 01 840 095</b>	<b>3637.96.00</b>	Izmenjivi podsklop Repair kit Reparatur satz	85	K45		

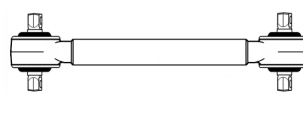
Originalni broj Cross-Ref.-No. Original Nr.	Br. FAD No. No.	Naziv Designation Bezeichnung	Kugla Ball Ø Größe	Konus Taper Konus	Dužina Length Länge	Skica Figure Bild
<b>50 01 842 823</b> 50 10 104 465	<b>5170.96.00</b>	Izmenjivi podsklop Repair kit Reparatur satz	70	Ø19 >30<	<130>	
<b>50 01 858 763</b>	<b>4681.20.00</b>	Zglob, RH 30x1.5 Ball joint, RH Kugelgelenk, RH	40	K30	125	
<b>50 01 860 359</b>	<b>4672.00.00</b>	Spona upravljača Drag link Lenkstange Izmenjivi delovi Parts list Stuckliste 5743.10.00 5743.20.00	40	K30	1690 RØ50	
<b>50 01 860 360</b>	<b>4737.00.00</b>	Spona upravljača Drag link Lenkstange  Izmenjivi delovi Parts list Stuckliste 6321.10.00 4563.20.00	40	K30	1442 RØ40	
<b>50 01 868 367</b> 50 10 587 050 50 10 587 053	<b>4710.00.00</b>	Spona upravljača Drag link Lenkstange  Izmenjivi delovi Parts list Stuckliste 5743.20.00 5743.10.00	40	K30	1676 RØ40	
<b>50 01 868 404</b> 50 10 587 049 50 10 587 052 74 21 560 965	<b>4733.00.00</b>	Poprečna spona Tie rod Spurstange  Izmenjivi delovi Parts list Stuckliste 6321.10.00 4563.20.00	40	K30	1719 RØ40	

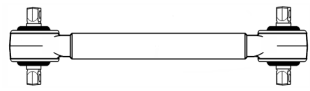
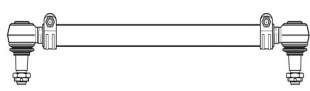
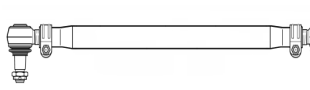
Originalni broj Cross-Ref.-No. Original Nr.	Br. FAD No. Nr.	Naziv Designation Bezeichnung	Kugla Ball Ø Größe	Konus Taper Konus	Dužina Length Länge	Skica Figure Bild
<b>50 10 005 937</b>	<b>3285.00.00</b>	Vodica mosta Torque rod Achsstrebe Izmenjivi delovi Parts list Stuckliste 5992.96.00	62	Ø17 >24< <122>	480  RØ50	
<b>50 10 025 292</b>	<b>3284.00.00</b>	Vodica mosta Torque rod Achsstrebe Izmenjivi delovi Parts list Stuckliste 3284.96.00	55	Ø15 >24< <100>	500  RØ50	
<b>50 10 037 602</b> 50 10 037 603 50 10 130 456	<b>3948.00.00</b>	Spona upravljača Drag link Lenkstange Izmenjivi delovi Parts list Stuckliste 5746.20.00	30	K22	902  RØ40	
<b>50 10 060 764</b> 50 10 557 243	<b>3297.00.00</b>	Spona upravljača Drag link Lenkstange  Izmenjivi delovi Parts list Stuckliste 5743.20.00	40	K30	720  RØ36	
<b>50 00 064 715</b> 50 10 130 382 74 85 114 932	<b>4725.00.00</b>	Spona upravljača Drag link Lenkstange  Izmenjivi delovi Parts list Stuckliste 5743.20.00	40	K30	830  RØ42	
<b>50 10 094 839</b>	<b>4690.00.00</b>	Vodica mosta Torque rod Achsstrebe  Izmenjivi delovi Parts list Stuckliste 4690.90.00	80	Ø21 >35< <152>	575  RØ62	

Originalni broj Cross-Ref.-No. Original Nr.	Br. FAD No. No.	Naziv Designation Bezeichnung	Kugla Ball Ø Größe	Konus Taper Konus	Dužina Length Länge	Skica Figure Bild
<b>50 10 094 840</b>	<b>3282.00.00</b>	Vođica mosta Torque rod Achsstrebe  Izmenjivi delovi Parts list Stuckliste 3282.90.00	65	Ø21 >35< <152>	575  RØ50	
<b>50 10 097 562</b>	<b>6359.00.00</b>	Poprečna spona Tie rod Spurstange  Izmenjivi delovi Parts list Stuckliste 5746.10.00 5746.20.00	30	K22	1404  RØ36	
<b>50 10 098 467</b> 50 10 145 584 50 10 439 631	<b>4675.00.00</b>	Poprečna spona Tie rod Spurstange  Izmenjivi delovi Parts list Stucklist 5743.10.00 5743.20.00	40	K30	1745  RØ50	
<b>50 10 130 344</b>	<b>3291.00.00</b>	Spona upravljača Drag link Lenkstange  Izmenjivi delovi Parts list Stuckliste 5743.20.00	40	K30	745  RØ52	
<b>50 10 145 078</b>	<b>4674.00.00</b>	Poprečna spona Tie rod Spurstange  Izmenjivi delovi Parts list Stuckliste 5856.10.00 5856.20.00	40	K30	1616  RØ50	



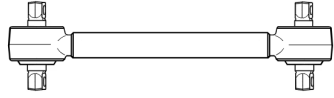
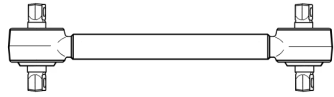
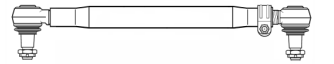
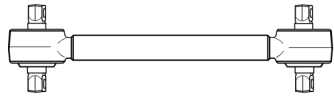
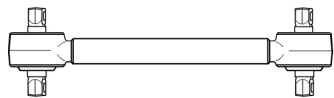

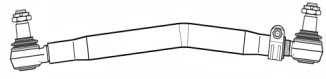
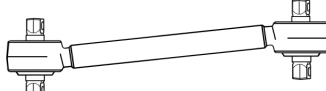
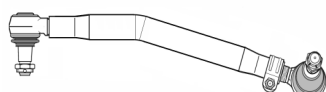
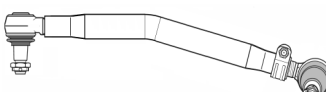
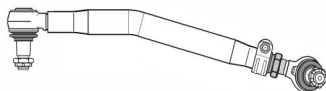
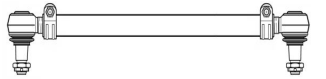

Originalni broj Cross-Ref.-No. Original Nr.	Br. FAD No. Nr.	Naziv Designation Bezeichnung	Kugla Ball Ø Größe	Konus Taper Konus	Dužina Length Länge	Skica Figure Bild
<b>50 10 197 399</b>	<b>3286.00.00</b>	Vođica mosta Torque rod Achsstrebe  Izmenjivi delovi Parts list Stuckliste 5992.96.00	62	Ø17 >24< <122>	570  RØ50	
<b>50 10 207 168</b>	<b>3287.00.00</b>	Vođica mosta Torque rod Achsstrebe  Izmenjivi delovi Parts list Stuckliste 5992.96.00	62	Ø17 >24< <122>	550  RØ50	
<b>50 10 207 725</b>	<b>4702.00.00</b>	Spona upravljača Drag link Lenkstange  Izmenjivi delovi Parts list Stuckliste 5743.20.00	40	K30	2085  RØ50	
<b>50 10 207 726</b>	<b>3944.00.00</b>	Vođica mosta Torque rod Achsstrebe  Izmenjivi delovi Parts list Stuckliste 5992.96.00	62	Ø17 >24< <122>	550  RØ50	
<b>50 10 207 727</b>	<b>3945.00.00</b>	Vođica mosta Torque rod Achsstrebe  Izmenjivi delovi Parts list Stuckliste 5992.96.00	62	Ø17 >24< <122>	692  RØ50	

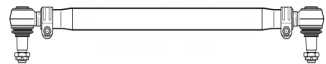
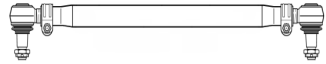
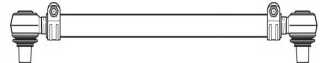
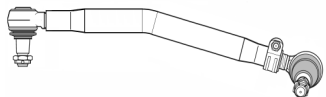
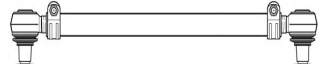
Originalni broj Cross-Ref.-No. Original Nr.	Br. FAD No. Nr.	Naziv Designation Bezeichnung	Kugla Ball Ø Größe	Konus Taper Konus	Dužina Length Länge	Skica Figure Bild
<b>50 10 207 728</b>	<b>4700.00.00</b>	Spona upravljača Drag link Lenkstange	40	K30	555 RØ40	
<b>50 10 207 729</b>	<b>4701.00.00</b>	Spona upravljača Drag link Lenkstange Izmenjivi delovi Parts list Stuckliste 5743.10.00 5743.20.00	40	K30	525 RØ40	
<b>50 10 207 771</b>	<b>3288.00.00</b>	Vođica mosta Torque rod Achsstrebe Izmenjivi delovi Parts list Stuckliste 5992.96.00	62	Ø17 >24< <122>	490 RØ50	
<b>50 10 216 608</b>	<b>4677.00.00</b>	Poprečna spona Tie rod Spurstange Izmenjivi delovi Parts list Stuckliste 5743.10.00 5743.20.00	40	K30	1516 RØ40	
<b>50 10 224 899</b>	<b>4735.00.00</b>	Poprečna spona Tie rod Spurstange Izmenjivi delovi Parts list Stuckliste 5805.10.00 57805.20.00	30	K20	1404 RØ30	
<b>50 10 229 243</b> 50 10 488 053	<b>4698.00.00</b>	Spona upravljača Drag link Lenkstange Izmenjivi delovi Parts list Stuckliste 4563.20.00	40	K30	934 RØ52	

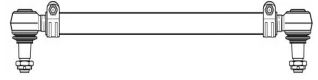
Originalni broj Cross-Ref.-No. Original Nr.	Br. FAD No. Nr.	Naziv Designation Bezeichnung	Kugla Ball Ø Größe	Konus Taper Konus	Dužina Length Länge	Skica Figure Bild
50 10 259 241 50 10 557 234 50 10557 524	4724.00.00	Spona upravljača Drag link Lenkstange Izmenjivi delovi Parts list Stuckliste 4712.20.00	40	K30	903 RØ50	
50 10 268 035	5994.00.00	Vođica mosta Torque rod Achsstrebe Izmenjivi delovi Parts list Stuckliste 5755.96.00	70	Ø19 >30< <145>	575 RØ50	
50 10 294 287	4670.00.00	Spona upravljača Drag link Lenkstange  Izmenjivi delovi Parts list Stuckliste 5743.20.00	40	K30	809 RØ50	
50 10 294 288	4668.00.00	Spona upravljača Drag link Lenkstange Izmenjivi delovi Parts list Stuckliste 5743.20.00	40	K30	825 RØ52	
50 10 294 289	4669.00.00	Spona upravljača Drag link Lenkstange Izmenjivi delovi Parts list Stuckliste 5743.20.00	40	K30	861 RØ60	
50 10 294 320	4730.00.00	Spona upravljača Drag link Lenkstange Izmenjivi delovi Parts list Stuckliste 6321.10.00 4563.20.00	40	K30	490 RØ40	

Originalni broj Cross-Ref.-No. Original Nr.	Br. FAD No. Nr.	Naziv Designation Bezeichnung	Kugla Ball Ø Größe	Konus Taper Konus	Dužina Length Länge	Skica Figure Bild
<b>50 10 308 082</b> 50 10 566 059	<b>4676.00.00</b>	Poprečna spona Tie rod Spurstange  Izmenjivi delovi Parts list Stuckliste 5743.10.00 5743.20.00	40	K30	1720  RØ50	
<b>50 10 308 083</b>	<b>4736.00.00</b>	Poprečna spona Tie rod Spurstange  Izmenjivi delovi Parts list Stuckliste 6832.10.00 4563.20.00	40	K30	1580  RØ50	
<b>50 10 308 214</b> 50 10 439 984	<b>4680.00.00</b>	Poprečna spona Tie rod Spurstange  Izmenjivi delovi Parts list Stuckliste 5741.10.00 5741.20.00	35	K26	1466  RØ36	
<b>50 10 383 203</b> 50 10 488 836	<b>4718.00.00</b>	Spona upravljača Drag link Lenkstange  Izmenjivi delovi Parts list Stuckliste 4718.20.00	40	K30	750  RØ50	
<b>50 10 393 015</b> 50 10 439 984	<b>4732.00.00</b>	Poprečna spona Tie rod Spurstange  Izmenjivi delovi Parts list Stuckliste 5741.10.00 5741.20.00	35	K26	776  RØ40	



Originalni broj Cross-Ref.-No. Original Nr.	Br. FAD No. Nr.	Naziv Designation Bezeichnung	Kugla Ball Ø Größe	Konus Taper Konus	Dužina Length Länge	Skica Figure Bild
<b>50 10 395 796</b> 50 10 566 049	<b>4678.00.00</b>	Poprečna spona Tie rod Spurstange  Izmenjivi delovi Parts list Stuckliste 5741.10.00 5741.20.00	35	K26	1500  RØ38	
<b>50 10 395 797</b> 50 10 566 050	<b>4715.00.00</b>	Poprečna spona Tie rod Spurstange  Izmenjivi delovi Parts list Stuckliste 5741.10.00 5741.20.00	35	K26	1575  RØ40	
<b>50 10 439 021</b> 50 10 566 063	<b>4682.00.00</b>	Poprečna spona Tie rod Spurstange  Izmenjivi delovi Parts list Stuckliste 4681.20.00	40	K30	1758  RØ52	
<b>50 10 439 022</b>	<b>4681.00.00</b>	Poprečna spona Tie rod Spurstange  Izmenjivi delovi Parts list Stuckliste 4681.20.00	40	K30	1720  RØ52	
<b>50 10 439 023</b> 50 10 566 063	<b>4699.00.00</b>	Poprečna spona Tie rod Spurstange  Izmenjivi delovi Parts list Stuckliste 6832.20.00	40	K30	1553  RØ52	

Originalni broj Cross-Ref.-No. Original Nr.	Br. FAD No. Nr.	Naziv Designation Bezeichnung	Kugla Ball Ø Größe	Konus Taper Konus	Dužina Length Länge	Skica Figure Bild
<b>50 10 439 078</b>	<b>4709.00.00</b>	Spona upravljača Drag link Lenkstange  Izmenjivi delovi Parts list Stuckliste 4712.20.00	40	K30	1376  RØ52	
<b>50 10 488 051</b>	<b>4713.00.00</b>	Poprečna spona Tie rod Spurstange  Izmenjivi delovi Parts list Stuckliste 5743.10.00 5743.20.00	40	K30	625  RØ36	
<b>50 10 488 052</b> 50 10 488 836	<b>4720.00.00</b>	Spona upravljača Drag link Lenkstange  Izmenjivi delovi Parts list Stuckliste 4563.20.00	40	K30	934  RØ52	
<b>50 10 488 084</b> 50 10 488 639 50 10 488 759 50 10 557 341	<b>4712.00.00</b>	Spona upravljača Drag link Lenkstange  Izmenjivi delovi Parts list Stuckliste 4712.20.00	40	K30	900  RØ50	
<b>50 10 488 096</b>	<b>4697.00.00</b>	Spona upravljača Drag link Lenkstange  Izmenjivi delovi Parts list Stuckliste 4712.20.00	40	K30	1125  RØ50	

Originalni broj Cross-Ref.-No. Original Nr.	Br. FAD No. Nr.	Naziv Designation Bezeichnung	Kugla Ball Ø Größe	Konus Taper Konus	Dužina Length Länge	Skica Figure Bild
<b>50 10 488 146</b>	<b>4719.00.00</b>	Spona upravljača Drag link Lenkstange  Izmenjivi delovi Parts list Stuckliste 4719.20.00	35	K26	940  RØ42	
<b>50 10 488 164</b>	<b>4708.00.00</b>	Spona upravljača Drag link Lenkstange  Izmenjivi delovi Parts list Stuckliste 5746.20.00	30	K22	886  RØ42	
<b>50 10 488 165</b>	<b>4722.00.00</b>	Spona upravljača Drag link Lenkstange  Izmenjivi delovi Parts list Stuckliste 5746.20.00	30	K22	883  RØ42	
<b>50 10 488 166</b>	<b>4721.00.00</b>	Spona upravljača Drag link Lenkstange  Izmenjivi delovi Parts list Stuckliste 4719.20.00	35	K26	940  RØ42	
<b>50 10 488 336</b> 50 10 557 233	<b>4696.00.00</b>	Spona upravljača Drag link Lenkstange  Izmenjivi delovi Parts list Stuckliste 4712.20.00	40	K30	910  RØ52	

Originalni broj Cross-Ref.-No. Original Nr.	Br. FAD No. Nr.	Naziv Designation Bezeichnung	Kugla Ball Ø Größe	Konus Taper Konus	Dužina Length Länge	Skica Figure Bild
<b>50 10 499 243</b> 50 10 517 082	<b>4716.00.00</b>	Spona upravljača Drag link Lenkstange  Izmenjivi delovi Parts list Stuckliste 5741.20.00	35	K26	922  RØ42	
<b>50 10 557 423</b>	<b>4707.00.00</b>	Spona upravljača Drag link Lenkstange  Izmenjivi delovi Parts list Stuckliste 5746.20.00	30	K22	891  RØ50	
<b>50 10 488 523</b>	<b>4694.00.00</b>	Spona upravljača Drag link Lenkstange  Izmenjivi delovi Parts list Stuckliste 4563.20.00	40	K30	760  RØ50	
<b>50 10 566 058</b>	<b>7762.00.00</b>	Poprečna spona Tie rod Spurstange  Izmenjivi delovi Parts list Stuckliste 5743.10.00 5743.20.00	40	K30	1650  RØ40	
<b>50 10 566 157</b>	<b>4714.00.00</b>	Poprečna spona Tie rod Spurstange  Izmenjivi delovi Parts list Stuckliste 5741.10.00 5741.20.00	35	K26	1650  RØ40	

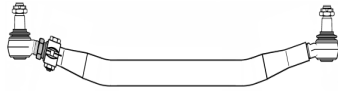
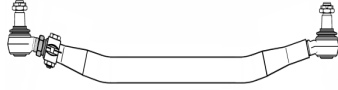
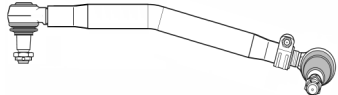

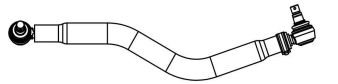
Originalni broj Cross-Ref.-No. Original Nr.	Br. FAD No. Nr.	Naziv Designation Bezeichnung	Kugla Ball Ø Größe	Konus Taper Konus	Dužina Length Länge	Skica Figure Bild
<b>50 10 587 004</b> 50 10 600 822	<b>4683.00.00</b>	Poprečna spona Tie rod Spurstange  Izmenjivi delovi Parts list Stuckliste 6832.20.00	40	K30	1732  RØ60	
<b>50 10 587 034</b> 50 10 587 038	<b>4685.00.00</b>	Poprečna spona Tie rod Spurstange  Izmenjivi delovi Parts list Stuckliste 6832.20.00	40	K30	1683  RØ60	
<b>50 10 600 483</b>	<b>4686.00.00</b>	Spona upravljača Drag link Lenkstange  Izmenjivi delovi Parts list Stuckliste 4686.20.00	40	K30	855  RØ60	
<b>50 10 630 254</b>	<b>4695.00.00</b>	Spona upravljača Drag link Lenkstange  Izmenjivi delovi Parts list Stuckliste 5741.20.00	35	K26	914  RØ42	
<b>50 10 630 812</b> 50 10 630 813	<b>4687.00.00</b>	Spona upravljača Drag link Lenkstange  Izmenjivi delovi Parts list Stuckliste 5743.20.00	40	K30	883  RØ60	

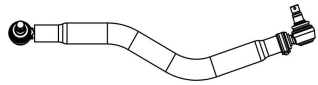
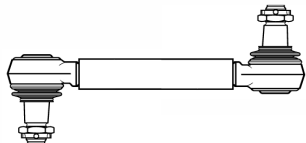
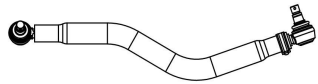
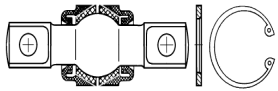
Originalni broj Cross-Ref.-No. Original Nr.	Br. FAD No. Nr.	Naziv Designation Bezeichnung	Kugla Ball Ø Größe	Konus Taper Konus	Dužina Length Länge	Skica Figure Bild
<b>50 10 630 822</b> 50 10 630 823	<b>4684.00.00</b>	Spona upravljača Drag link Lenkstange  Izmenjivi delovi Parts list Stuckliste 5743.20.00	40	K30	860  RØ60	
<b>720 128</b>	<b>4667.00.00</b>	Spona upravljača Drag link Lenkstange	35	K26	335  RØ36	
<b>7420 761 145</b>	<b>4688.00.00</b>	Spona upravljača Drag link Lenkstange  Izmenjivi delovi Parts list Stuckliste 4668.20.00	40	K30	893  RØ60	
<b>77 01 011 267</b>	<b>3698.90.00</b>	Izmenjivi podsklop Repair kit Reparatur satz	65	Ø19 >30<	<130>	

Originalni broj Cross-Ref.No. Original Nr.	Br. FAD No. No. Nr.	Naziv Designation Bezeichnung	Kugla Ball Ø Größe	Konus Taper Konus	Dužina Length Länge	Skica Figure Bild
<b>1 104 334</b> 550 806 639 370	<b>5323.96.00</b>	Izmenjivi podsklop Repair kit Reparatur satz	62	Ø17 >24<	<115>	
<b>1 104 335</b> 639 287 638 862	<b>5170.96.00</b>	Izmenjivi podsklop Repair kit Reparatur satz	70	Ø19 >30<	<130>	
<b>1 104 336</b>	<b>5587.96.00</b>	Izmenjivi podsklop Repair kit Reparatur satz	78.5	Ø23 >35<	<152>	
<b>114 406</b>	<b>5048.96.00</b>	Izmenjivi podsklop Repair kit Reparatur satz	108	Ø36		
<b>1 304 569</b>	<b>3087.00.00</b>	Spona upravljača Drag link Lenkstange  Izmenjivi delovi Parts list Stuckliste 5743.20.00	40	K30	905  RØ50	
<b>1 324 890</b>	<b>6842.00.00</b>	Vođica mosta Torque rod Achsstrebe  Izmenjivi delovi Parts list Stuckliste 5323.96.00	62	Ø17 >24< <115>	697  RØ50	

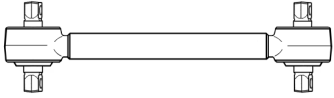
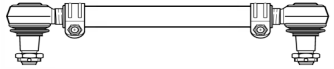
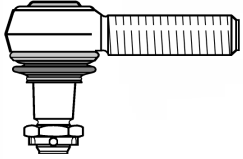
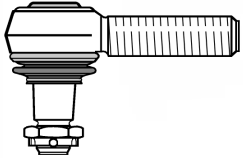
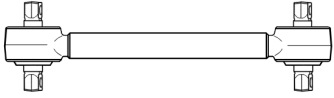
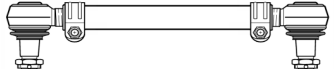
Originalni broj Cross-Ref.-No. Original Nr.	Br. FAD No. No.	Naziv Designation Bezeichnung	Kugla Ball Ø Größe	Konus Taper Konus	Dužina Length Länge	Skica Figure Bild
<b>1 326 775</b>	<b>3084.00.00</b>	Vođica mosta Torque rod Achsstrebe  Izmenjivi delovi Parts list Stuckliste 5323.96.00	62	Ø17 >24< <115>	522  RØ50	
<b>1 334 139</b>	<b>6830.00.00</b>	Spona upravljača Drag link Lenkstange  Izmenjivi delovi Parts list Stuckliste 5743.10.00 5743.20.00	40	K30	786  RØ40	
<b>1 337 366</b> 352 645	<b>5810.10.00</b>	Zglob, LH M30x1.5 Ball joint, LH Kugelgelenk, LH	50	K30	135	
<b>1 337 367</b> 352 646	<b>5810.20.00</b>	Zglob, RH M30x1.5 Ball joint, RH Kugelgelenk, RH	50	K30	135	
<b>1 338 769</b> 1 428 347	<b>3083.00.00</b>	Vođica mosta Torque rod Achsstrebe  Izmenjivi delovi Parts list Stuckliste 5323.96.00	62	Ø17 >24< <115>	568  RØ50	
<b>1 343 266</b> 1 759 690	<b>6835.00.00</b>	Spona upravljača Drag link Lenkstange  Izmenjivi delovi Parts list Stuckliste 5743.10.00 5743.20.00	40	K30	495  RØ40	

Originalni broj Cross-Ref.-No. Original Nr.	Br. FAD No. Nr.	Naziv Designation Bezeichnung	Kugla Ball Ø Größe	Konus Taper Konus	Dužina Length Länge	Skica Figure Bild
<b>1 343 278</b>	<b>4776.00.00</b>	Spona upravljača Drag link Lenkstange	40	K30	2796 RØ62	
<b>1 343 283</b> 1 759 691	<b>6838.00.00</b>	Spona upravljača Drag link Lenkstange Izmenjivi delovi Parts list Stuckliste 5743.10.00 6832.20.00	40	K30	435 RØ40	
<b>1 357 674</b>	<b>6832.20.00</b>	Zglob,RH M30x1,5 Ball joint, RH Kugelgelenk, RH	40	K30	140	
<b>1 358 792</b> 1 738 380 1 767 328 283 784 395 010	<b>5743.10.00</b>	Zglob,RH M30x1.5 Ball joint, RH Kugelgelenk, RH	40	K30	120	
<b>1 358 793</b> 1 738 381 283 783 395 009	<b>5743.20.00</b>	Zglob, LH M30x1.5 Ball joint, LH Kugelgelenk, LH	40	K30	120	
<b>1 361 413</b> 1 395 614 1 734 019 1 897 333	<b>6832.00.00</b>	Poprečna spona Tie rod Spurstange Izmenjivi delovi Parts list Stuckliste 6832.20.00	40	K30	1743 RØ52	
<b>1 367 282</b>	<b>3343.00.00</b>	Vodica mosta Torque rod Achsstrebe Izmenjivi delovi Parts list Stuckliste 5323.96.00	62	Ø17 >24< <115>	540 RØ50	

Originalni broj Cross-Ref.-No. Original Nr.	Br. FAD No. Nr.	Naziv Designation Bezeichnung	Kugla Ball Ø Größe	Konus Taper Konus	Dužina Length Länge	Skica Figure Bild
<b>1 369 917</b>	<b>4773.00.00</b>	Poprečna spona Tie rod Spurstange  Izmenjivi delovi Parts list Stuckliste 5743.20.00	40	K30	578  RØ40	
<b>1 376 902</b>	<b>7523.20.00</b>	Zglob,RH M24x1,5* Ball joint, RH Kugelgelenk, RH	35	K26	90	
<b>1 379 423</b>	<b>3343.00.00</b>	Vođica mosta Torque rod Achsstrebe  Izmenjivi delovi Parts list Stuckliste 5323.96.00	62	Ø17 >24< <115>	752  RØ50	
<b>1 383 405</b>	<b>3089.20.00</b>	Zglob, RH 16x1.5 Ball joint, RH Kugelgelenk, RH	22	K12	85	
<b>1 384 025</b> 1 768 898	<b>3082.00.00</b>	Spona upravljača Drag link Lenkstange  Izmenjivi delovi Parts list Stuckliste 5743.20.00	40	K30	1055  RØ52	
<b>1 384 027</b> 1 769 597	<b>6847.00.00</b>	Spona upravljača Drag link Lenkstange  Izmenjivi delovi Parts list Stuckliste 5743.20.00	40	K30	1050  RØ52	

Originalni broj Cross-Ref.-No. Original Nr.	Br. FAD No. Nr.	Naziv Designation Bezeichnung	Kugla Ball Ø Größe	Konus Taper Konus	Dužina Length Länge	Skica Figure Bild
<b>1 385 251</b> 1 409 918 1 501 030 1 723 895 1 737 683 1 897 335	<b>6833.00.00</b>	Poprečna spona Tie rod Spurstange  Izmenjivi delovi Parts list Stuckliste 5743.20.00	40	K30	1743  RØ50	
<b>1 393 298</b>	<b>6841.00.00</b>	Vođica mosta Torque rod Achsstrebe  Izmenjivi delovi Parts list Stuckliste 6409.96.00	55	Ø17 >24< <115>	752 RØ50	
<b>1 394 443</b>	<b>7981.20.00</b>	Zglob, RH 26x1.5 * Ball joint, RH Kugelgelenk, RH	40	K30	75	
<b>1 394 444</b>	<b>7982.20.00</b>	Zglob, RH 26x1.5 * Ball joint, RH Kugelgelenk, RH	40	K30	90	
<b>1 394 884</b>	<b>6849.00.00</b>	Poprečna spona Tie rod Spurstange  Izmenjivi delovi Parts list Stuckliste 5743.20.00	40	K30	438  RØ40	
<b>1 397 866</b> 1 734 020 395 350	<b>3126.00.00</b>	Poprečna spona Tie rod Spurstange  Izmenjivi delovi Parts list Stuckliste 5743.20.00 5743.10.00	40	K30	1736  RØ40	

Originalni broj Cross-Ref.-No. Original Nr.	Br. FAD No. No.	Naziv Designation Bezeichnung	Kugla Ball Ø Größe	Konus Taper Konus	Dužina Length Länge	Skica Figure Bild
<b>1 399 180</b>	<b>6831.00.00</b>	Vodica mosta Torque rod Achsstrebe Izmenjivi delovi Parts list Stuckliste 5323.96.00	62	Ø17 >24< <115>	568 RØ50	
<b>1 399 182</b>	<b>4791.00.00</b>	Vodica mosta Torque rod Achsstrebe  Izmenjivi delovi Parts list Stuckliste 5323.96.00	62	Ø17 >24< <115>	580 RØ50	
<b>1 431 471</b> 477 889	<b>4785.00.00</b>	Vodica mosta Torque rod Achsstrebe  Izmenjivi delovi Parts list Stuckliste 5323.96.00	62	Ø17 >24< <115>	532 RØ50	
<b>1 431 472</b> 1 770 732 477 890	<b>4779.00.00</b>	Vodica mosta Torque rod Achsstrebe  Izmenjivi delovi Parts list Stuckliste 5323.96.00	62	Ø17 >24< <115>	637 RØ50	
<b>1 431 475</b> 481 959	<b>4782.00.00</b>	Vodica mosta Torque rod Achsstrebe Izmenjivi delovi Parts list Stuckliste 5170.96.00	70	Ø19 >30< <130>	670 RØ50	
<b>1 438 475</b>	<b>4792.00.00</b>	Vodica mosta Torque rod Achsstrebe Izmenjivi delovi Parts list Stuckliste 5323.96.00	62	Ø17 >24< <115>	539 RØ50	



Originalni broj Cross-Ref.-No. Original Nr.	Br. FAD No. Nr.	Naziv Designation Bezeichnung	Kugla Ball Ø Größe	Konus Taper Konus	Dužina Length Länge	Skica Figure Bild
<b>1 485 758</b> 1 486 757	<b>4780.00.00</b>	Vodica mosta Torque rod Achsstrebe  Izmenjivi delovi Parts list Stuckliste 4780.96.00	55	Ø19 >24< <115>	568.5 RØ46	
<b>1 485 760</b> 1 499 478 1 722 750	<b>6864.00.00</b>	Vodica mosta Torque rod Achsstrebe  Izmenjivi delovi Parts list Stuckliste 5521.96.00	62	Ø19 >24< <115>	616,5 RØ50	
<b>1 486 758</b>	<b>4781.00.00</b>	Vodica mosta Torque rod Achsstrebe  Izmenjivi delovi Parts list Stuckliste 4780.96.00	55	Ø19 >24< <115>	522 RØ46	
<b>1 488 890</b> 1 534 756	<b>4126.20.00</b>	Zglob, RH 30x1.5 Ball joint, RH Kugelgelenk, RH	40	K30	141	
<b>1 499 474</b> 1 722 746	<b>6861.00.00</b>	Vodica mosta Torque rod Achsstrebe  Izmenjivi delovi Parts list Stuckliste 5521.96.00	62	Ø19 >24< <115>	568 RØ50	
<b>1 499 475</b> 1 722 747	<b>6862.00.00</b>	Vodica mosta Torque rod Achsstrebe  Izmenjivi delovi Parts list Stuckliste 5521.96.00	62	Ø19 >24< <115>	568,5 RØ50	



Originalni broj Cross-Ref.-No. Original Nr.	Br. FAD No. Nr.	Naziv Designation Bezeichnung	Kugla Ball Ø Größe	Konus Taper Konus	Dužina Length Länge	Skica Figure Bild
<b>1 499 476</b> 1 722 748	<b>6860.00.00</b>	Vodica mosta Torque rod Achsstrebe  Izmenjivi delovi Parts list Stuckliste 5521.96.00	62	Ø19 >24< <115>	592  RØ50	
<b>1 499 477</b> 1 722 749	<b>6863.00.00</b>	Vodica mosta Torque rod Achsstrebe  Izmenjivi delovi Parts list Stuckliste 5521.96.00	62	Ø19 >24< <115>	606  RØ50	
<b>1 499 479</b> 1 722 751	<b>6865.00.00</b>	Vodica mosta Torque rod Achsstrebe  Izmenjivi delovi Parts list Stuckliste 5521.96.00	62	Ø19 >24< <115>	629  RØ50	
<b>1 500 572</b>	<b>4789.00.00</b>	Vodica mosta Torque rod Achsstrebe  Izmenjivi delovi Parts list Stuckliste 5323.96.00	62	Ø17 >24< <115>	568.5  RØ50	
<b>1 527 978</b> 1 723 896 1 737 684 1 897 336	<b>4793.00.00</b>	Poprečna spona Tie rod Spurstange  Izmenjivi delovi Parts list Stuckliste 4133.20.00	40	K30	1743  RØ52	
<b>1 766 015</b> 445 626	<b>6851.00.00</b>	Stabilizator Stabillizer link Koppelstang	35	K26	130  RØ32	

Originalni broj Cross-Ref.-No. Original Nr.	Br. FAD No. Nr.	Naziv Designation Bezeichnung	Kugla Ball Ø Größe	Konus Taper Konus	Dužina Length Länge	Skica Figure Bild
<b>1 897 669</b> 481 217	<b>4770.00.00</b>	Spona upravljača Drag link Lenkstange  Izmenjivi delovi Parts list Stuckliste 5743.20.00	40	K30	1256  RØ62	
<b>1 897 671</b>	<b>4777.00.00</b>	Spona upravljača Drag link Lenkstange  Izmenjivi delovi Parts list Stuckliste 5856.20.00	40	K30	1256  RØ62	
<b>1 897 673</b> 475 463	<b>6834.00.00</b>	Spona upravljača Drag link Lenkstange  Izmenjivi delovi Parts list Stuckliste 5743.20.00	40	K30	870  RØ50	
<b>278 665</b>	<b>3148.00.00</b>	Spona upravljača Drag link Lenkstange  Izmenjivi delovi Parts list Stuckliste 5743.20.00	40	K30	940  RØ42	
<b>291 396</b>	<b>6840.00.00</b>	Spona upravljača Drag link Lenkstange  Izmenjivi delovi Parts list Stuckliste 5743.20.00	40	K30	728  RØ40	

Originalni broj Cross-Ref.-No. Original Nr.	Br. FAD No. Nr.	Naziv Designation Bezeichnung	Kugla Ball Ø Größe	Konus Taper Konus	Dužina Length Länge	Skica Figure Bild
<b>306 981</b>	<b>3149.00.00</b>	Spona upravljača Drag link Lenkstange  Izmenjivi delovi Parts list Stuckliste 5743.20.00	40	K30	940  RØ42	
<b>345 124</b>	<b>3348.00.00</b>	Spona upravljača Drag link Lenkstange  Izmenjivi delovi Parts list Stuckliste 5743.20.00	40	K30	908  RØ50	
<b>388 943</b>	<b>6836.00.00</b>	Spona upravljača Drag link Lenkstange Izmenjivi delovi Parts list Stuckliste 5743.10.00 5743.20.00	40	K30	611  RØ40	
<b>390 784</b>	<b>3081.00.00</b>	Spona upravljača Drag link Lenkstange Izmenjivi delovi Parts list Stuckliste 5743.20.00	40	K30	850  RØ42	
<b>409 639</b>	<b>3368.00.00</b>	Vođica mosta Torque rod Achsstrebe Izmenjivi delovi Parts list Stuckliste 5170.96.00 5847.96.00	70	Ø19 >30< K45	750  RØ50	
<b>414 531</b>	<b>3138.00.00</b>	Vođica mosta Torque rod Achsstrebe Izmenjivi delovi Parts list Stuckliste 5170.96.00	70	Ø19 >30< <130>	750  RØ50	

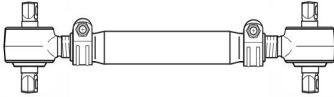
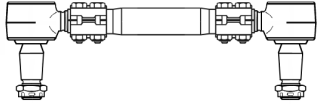
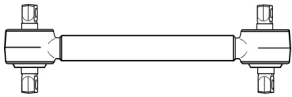
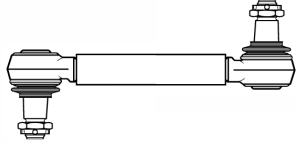
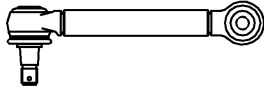
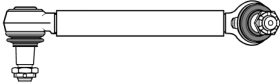

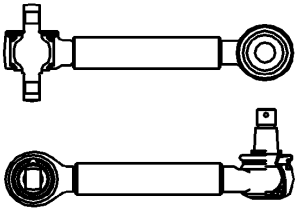
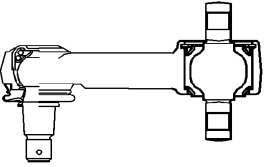
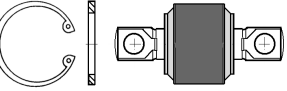
Originalni broj Cross-Ref.-No. Original Nr.	Br. FAD No. Nr.	Naziv Designation Bezeichnung	Kugla Ball Ø Größe	Konus Taper Konus	Dužina Length Länge	Skica Figure Bild
<b>415 400</b>	<b>4771.00.00</b>	Spona upravljača Drag link Lenkstange Izmenjivi delovi Parts list Stuckliste 5743.20.00	40	K30	1015 RØ50	
<b>416 159</b>	<b>6868.00.00</b>	Stabilizator Stabillizer link Koppelstang	30	K20	210 RØ28	
<b>417 290</b>	<b>3369.00.00</b>	Vođica mosta Torque rod Achsstrebe Izmenjivi delovi Parts list Stuckliste 5170.96.00	70	Ø19 >30<	635 RØ50	
<b>417 676</b>	<b>4778.00.00</b>	Spona upravljača Drag link Lenkstange Izmenjivi delovi Parts list Stuckliste 5743.20.00	40	K30	1015 RØ52	
<b>421 573</b>	<b>6837.00.00</b>	Spona upravljača Drag link Lenkstange Izmenjivi delovi  Parts list Stuckliste 5743.10.00 5743.20.00	40	K30	1123 RØ40	
<b>434 493</b>	<b>4795.00.00</b>	Spona upravljača Drag link Lenkstange Izmenjivi delovi  Parts list Stuckliste 6321.10.00 4563.20.00	40	K30	672 RØ40	

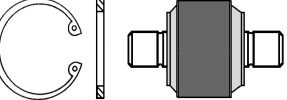
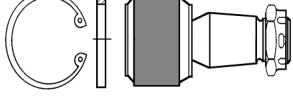

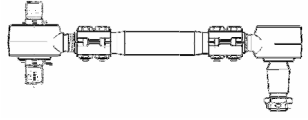
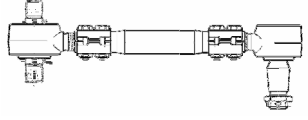
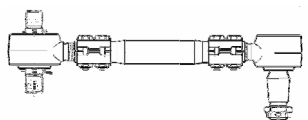
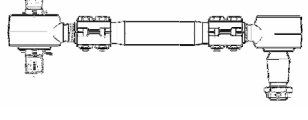
Originalni broj Cross-Ref.-No. Original Nr.	Br. FAD No. Nr.	Naziv Designation Bezeichnung	Kugla Ball Ø Größe	Konus Taper Konus	Dužina Length Länge	Skica Figure Bild
<b>445 599</b> 489 989	<b>3361.00.00</b>	Vođica mosta Torque rod Achsstrebe  Izmenjivi delovi Parts list Stuckliste 5170.96.00	70	Ø19 >30< <130>	650  RØ50	
<b>445 629</b>	<b>6853.00.00</b>	Vođica mosta Torque rod Achsstrebe  Izmenjivi delovi Parts list Stuckliste 5847.96.00	70	K45	725  RØ50	
<b>465 816</b> 466 801 489 987	<b>3362.00.00</b>	Vođica mosta Torque rod Achsstrebe  Izmenjivi delovi Parts list Stuckliste 5170.96.00	70	Ø19 >30< <130>	650  RØ50	
<b>483 527</b>	<b>6844.00.00</b>	Stabilizator Stabillizer link Koppelstang	35	K26	282  RØ36	
<b>486 590</b>	<b>4787.00.00</b>	Stabilizator Stabillizer link Koppelstang	35	K26	160  RØ32	
<b>488 056</b>	<b>4788.00.00</b>	Stabilizator Stabillizer link Koppelstang	35	K26	160  RØ32	



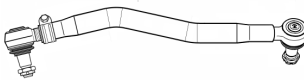
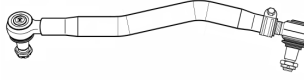
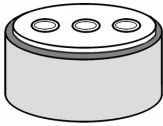

Originalni broj Cross-Ref.-No. Original Nr.	Br. FAD No. Nr.	Naziv Designation Bezeichnung	Kugla Ball Ø Größe	Konus Taper Konus	Dužina Length Länge	Skica Figure Bild
<b>488 738</b>	<b>4783.00.00</b>	Stabilizator Stabilizer link Koppelstang  Izmenjivi delovi Parts list Stuckliste 5522.96.00	40/45	K30	293 RØ36	
<b>488 739</b>	<b>4784.00.00</b>	Stabilizator Stabilizer link Koppelstang  Izmenjivi delovi Parts list Stuckliste 5522.96.00	35/45	K26	145 RØ32	
<b>550 808</b>	<b>6409.96.00</b>	Izmenjivi podsklop Repair kit Reparatur satz	55	Ø17 >24<	<115>	
<b>621 863</b>	<b>3363.00.00</b>	Vođica mosta Torque rod Achsstrebe  Izmenjivi delovi Parts list Stuckliste 3363.96.00	70	>32<	990 RØ50	
<b>638 860</b>	<b>3363.96.00</b>	Izmenjivi podsklop Repair kit Reparatur satz	70	Ø32	166	
<b>638 861</b>	<b>5847.96.00</b>	Izmenjivi podsklop Repair kit Reparatur satz	85	K45	133	

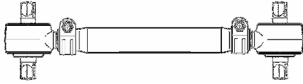

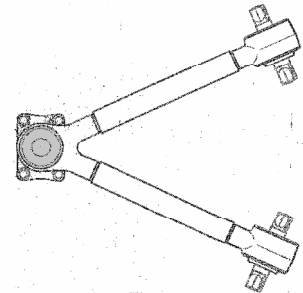
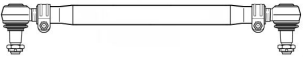
Originalni broj Cross-Ref.-No. Original Nr.	Br. FAD No. Nr.	Naziv Designation Bezeichnung	Kugla Ball Ø Größe	Konus Taper Konus	Dužina Length Länge	Skica Figure Bild
<b>649 346</b>	<b>3364.00.00</b>	Vođica mosta Torque rod Achsstrebe  Izmenjivi delovi Parts list Stuckliste 3363.96.00 5847.96.00	70	K45 Ø32	803  RØ50	
<b>651 156</b>	<b>3365.00.00</b>	Vođica mosta Torque rod Achsstrebe  Izmenjivi delovi Parts list Stuckliste 3363.96.00 5847.96.00	70	K45 Ø32	725  RØ50	
<b>651 157</b>	<b>3366.00.00</b>	Vođica mosta Torque rod Achsstrebe  Izmenjivi delovi Parts list Stuckliste 3363.96.00 5847.96.00	70	K45 Ø32	803  RØ50	
<b>651 158</b>	<b>3367.00.00</b>	Vođica mosta Torque rod Achsstrebe  Izmenjivi delovi Parts list Stuckliste 5847.96.00	70	K45	800  RØ50	

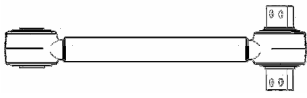

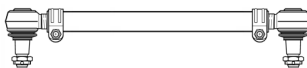

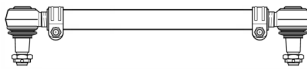

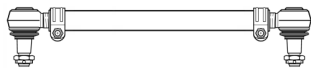
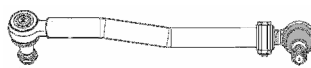
Originalni broj Cross-Ref.-No. Original Nr.	Br. FAD No. Nr.	Naziv Designation Bezeichnung	Kugla Ball Ø Größe	Konus Taper Konus	Dužina Length Länge	Skica Figure Bild
<b>1 071 170</b> 20 400 940	<b>4250.00.00</b>	Spona upravljača Drag link Lenkstange  Izmenjivi delovi Parts list Stuckliste 5741.20.00	35	K26	821  RØ42	
<b>1 071 344</b> 20 400 944 3 127 737	<b>6264.00.00</b>	Spona upravljača Drag link Lenkstange  Izmenjivi delovi Parts list Stuckliste 5741.20.00	35	K26	871  RØ52	
<b>1 075 005</b>	<b>6725.00.00</b>	Spona upravljača Drag link Lenkstange  Izmenjivi delovi Parts list Stuckliste 5596.20.00	35	K28.6	863  RØ52	
<b>1 075 006</b> 85 114 190	<b>4243.00.00</b>	Spona upravljača Drag link Lenkstange  Izmenjivi delovi Parts list Stuckliste 5596.20.00	35	K28.6	863  RØ52	
<b>1 075 255</b> 1 591 689 20 554 908 3 173 759	<b>5580.90.00</b>	Izmenjivi podsklop Repair kit Reparatur satz	138	K87	96	

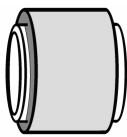
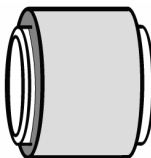
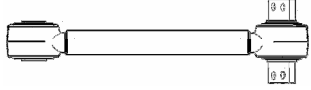

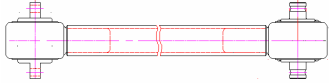
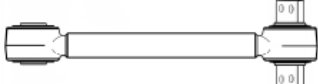
Originalni broj Cross-Ref.-No. Original Nr.	Br. FAD No. Nr.	Naziv Designation Bezeichnung	Kugla Ball Ø Größe	Konus Taper Konus	Dužina Length Länge	Skica Figure Bild
<b>1 075 260</b> 1 629 072	<b>4256.00.00</b>	Vođica mosta Torque rod Achsstrebe Izmenjivi delovi Parts list Stuckliste 5581.90.00	91	Ø14 <125>	666 RØ50	
<b>1 075 663</b> 3 988 704	<b>5141.00.00</b>	Spona upravljača Drag link Lenkstange  Izmenjivi delovi Parts list Stuckliste 3546.20.00	40	K28.6	870 RØ52	
<b>1 075 664</b> 3 988 701	<b>4224.00.00</b>	Spona upravljača Drag link Lenkstange  Izmenjivi delovi Parts list Stuckliste 5596.20.00	35	K28.6	861 RØ52	
<b>1 080 690</b> 1 606 200	<b>5587.00.00</b>	V-Vođica mosta Torque rod Achsstrebe  Izmenjivi delovi Parts list Stuckliste 5587.96.00 5943.90.00	80	Ø23 >35< <152> K46	636 RØ58	
<b>1 080 792</b>	<b>6732.00.00</b>	Poprečna spona Tie rod Spurstange  Izmenjivi delovi Parts list Stuckliste 7720.10.00 7720.20.00	40	K31.5	1640 RØ50	

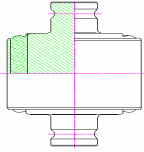
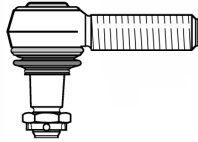
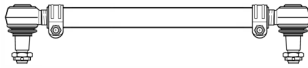

Originalni broj Cross-Ref.-No. Original Nr.	Br. FAD No. Nr.	Naziv Designation Bezeichnung	Kugla Ball Ø Größe	Konus Taper Konus	Dužina Length Länge	Skica Figure Bild
<b>1 082 104</b>	<b>6758.00.00</b>	Vodica mosta Torque rod Achsstrebe  Izmenjivi delovi Parts list Stuckliste 5581.90.00 5597.90.00	91	Ø14 >20< <125>	666  RØ58	
<b>1 083 744</b>	<b>6729.00.00</b>	Spona upravljača Drag link Lenkstange  Izmenjivi delovi Parts list Stuckliste 7720.20.00	40	K31.5	845  RØ42	
<b>1 088 985</b> 20 393 083	<b>6768.00.00</b>	Spona upravljača Drag link Lenkstange  Izmenjivi delovi Parts list Stuckliste 5596.10.00 5596.20.00	35	K28.6	572  RØ40	
<b>1 094 219</b>	<b>4216.00.00</b>	Spona upravljača Drag link Lenkstange  Izmenjivi delovi Parts list Stuckliste 7720.20.00	40	K31.5	800  RØ60	
<b>1 094 334</b> 1 575 690	<b>4219.00.00</b>	Spona upravljača Drag link Lenkstange  Izmenjivi delovi Parts list Stuckliste 7720.10.00 7720.20.00	40	K31.5	750  RØ40	

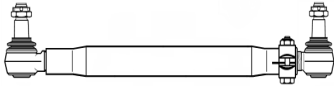
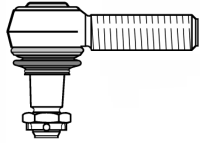
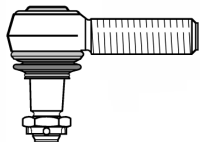
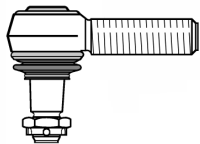
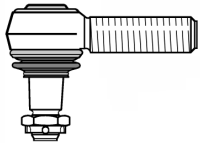
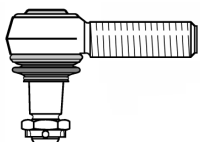
Originalni broj Cross-Ref.-No. Original Nr.	Br. FAD No. Nr.	Naziv Designation Bezeichnung	Kugla Ball Ø Größe	Konus Taper Konus	Dužina Length Länge	Skica Figure Bild
<b>1 130 567</b> 1 612 781 1 614 838 85 114 197	<b>6733.00.00</b>	Spona upravljača Drag link Lenkstange Izmenjivi delovi  Parts list Stuckliste 7720.10.00 7720.20.00	40	K31.5	702  RØ42	
<b>1 130 568</b>	<b>6765.00.00</b>	Spona upravljača Drag link Lenkstange  Izmenjivi delovi Parts list Stuckliste 6765.20.00	40	K32	1095  RØ50	
<b>1 134 840</b>	<b>4247.00.00</b>	Spona upravljača Drag link Lenkstange  Izmenjivi delovi Parts list Stuckliste 7720.20.00	40	K31.5	1114  RØ52	
<b>1 134 955</b>	<b>5388.90.00</b>	Izmenjivi podsklop Repair kit Reparatur satz	57.5	Ø28	55	
<b>1 135 030</b>	<b>5597.90.00</b>	Izmenjivi podsklop Repair kit Reparatur satz	91.3	Ø52	74	
<b>1 135 427</b>	<b>5599.00.00</b>	Vodica mosta Torque rod Achsstrebe  Izmenjivi delovi Parts list Stuckliste 5597.90.00 5581.90.00	91	Ø14 >20< <125>	666  RØ58	

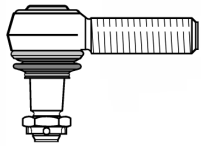
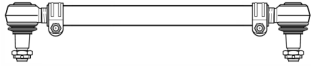
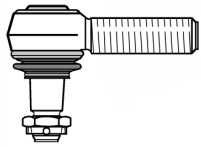
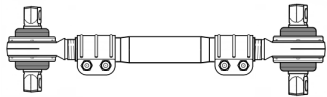

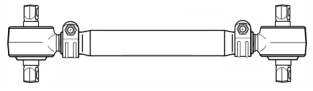

Originalni broj Cross-Ref.-No. Original Nr.	Br. FAD No. Nr.	Naziv Designation Bezeichnung	Kugla Ball Ø Größe	Konus Taper Konus	Dužina Length Länge	Skica Figure Bild
<b>1 135 428</b>	<b>6751.00.00</b>	Vođica mosta Torque rod Achsstrebe  Izmenjivi delovi Parts list Stuckliste 5581.90.00 6751.90.00	91	Ø14 >20< <125>	666  RØ58	
<b>1 135 429</b> 8 365 399	<b>6756.00.00</b>	Vođica mosta Torque rod Achsstrebe  Izmenjivi delovi Parts list Stuckliste 5597.90.00 5581.90.00	91	Ø14 >20< <125>	510  RØ58	
<b>1 135 630</b>	<b>4242.00.00</b>	Spona upravljača Drag link Lenkstange  Izmenjivi delovi Parts list Stuckliste 7720.20.00	40	K31.5	1041  RØ52	
<b>1 136 891</b>	<b>6751.90.00</b>	Izmenjivi podsklop Repair kit Reparatur satz	91.4	Ø31.7	150	
<b>1 190 778</b> 1 517 449 1 518 142	<b>5805.20.00</b>	Zglob, RH 24x1,5 Ball joint, RH Kugelgelenk, RH	30	K20	95	
<b>1 194 390</b>	<b>6753.00.00</b>	Poprečna spona Tie rod Spurstange Izmenjivi delovi Parts list Stuckliste 7720.10.00 7720.20.00	40	K31.5	1674  RØ42	

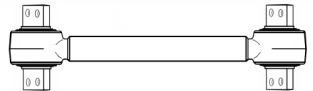
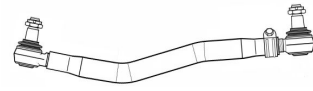
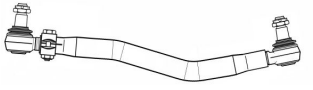
Originalni broj Cross-Ref.-No. Original Nr.	Br. FAD No. Nr.	Naziv Designation Bezeichnung	Kugla Ball Ø Größe	Konus Taper Konus	Dužina Length Länge	Skica Figure Bild
<b>1 197 338</b>	<b>5493.00.00</b>	Spona upravljača Drag link Lenkstange Izmenjivi delovi Parts list Stuckliste 5493.20.00	40	K31.5	1025  RØ60	
<b>1 197 339</b>	<b>4252.00.00</b>	Spona upravljača Drag link Lenkstange Izmenjivi delovi Parts list Stuckliste 7720.20.00	40	K31.5	1028  RØ60	
<b>1 505 758</b> 1 507 822 1 698 533 1 698 847	<b>3546.10.00</b>	Zglob,LH M30x1.5 Ball joint, LH Kugelgelenk, LH	40	K28.6	120	
<b>1 505 759</b> 1 507 823 1 698 532 1 698 846	<b>3546.20.00</b>	Zglob, RH 30x1.5 Ball joint, RH Kugelgelenk, RH	40	K28.6	120	
<b>1 507 826</b> 1 695 585 1 695 776 1 698 557	<b>7720.20.00</b>	Zglob, RH 30x1.5 Ball joint, RH Kugelgelenk, RH	40	K31.5	120	
<b>1 517 439</b> 1 698 190	<b>5746.10.00</b>	Zglob, LH 28x1.5 Ball joint, LH Kugelgelenk, LH	30	K22	105	
<b>1 517 440</b> 1 517 444 1 698 190	<b>5746.2 0.00</b>	Zglob,RH 28x1.5 Ball joint, RH Kugelgelenk, RH	30	K22	105	

Originalni broj Cross-Ref.-No. Original Nr.	Br. FAD No. Nr.	Naziv Designation Bezeichnung	Kugla Ball Ø Größe	Konus Taper Konus	Dužina Length Länge	Skica Figure Bild
<b>1 517 448</b>	<b>5805.10.00</b>	Zglob, LH 24x1.5 Ball joint, LH Kugelgelenk, LH	30	K20	95	
<b>1 524 382</b> 20 742 117	<b>4267.00.00</b>	Poprečna spona Tie rod Spurstange  Izmenjivi delovi Parts list Stuckliste 6321.10.00 4563.20.00	40	K30	1528  RØ42	
<b>1 527 234</b> 382 745	<b>6762.20.00</b>	Zglob, RH 28x1.5 Ball joint, RH Kugelgelenk, RH	25	K16	85	
<b>1 573 572</b>	<b>6750.00.00</b>	Vodica mosta Torque rod Achsstrebe  Izmenjivi delovi Parts list Stuckliste 6750.20.00 6750.10.00	53	Ø20 >24< <102>	357  RØ50	
<b>1 576 092</b> 1 606 283	<b>3074.00.00</b>	Spona upravljača Drag link Lenkstange  Izmenjivi delovi Parts list Stuckliste 7720.20.00	40	K31.5	885  RØ42	
<b>1 576 093</b> 1 606 284	<b>7720.00.00</b>	Spona upravljača Drag link Lenkstange  Izmenjivi delovi Parts list Stuckliste 7720.20.00	40	K31.5	870  RØ42	

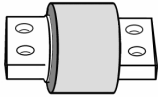

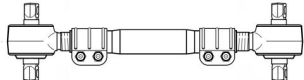
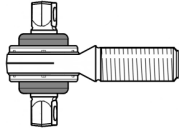
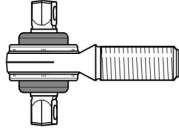
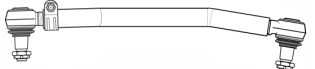
Originalni broj Cross-Ref.-No. Original Nr.	Br. FAD No. Nr.	Naziv Designation Bezeichnung	Kugla Ball Ø Größe	Konus Taper Konus	Dužina Length Länge	Skica Figure Bild
<b>1 576 816</b> 1 587 489 1 606 282	<b>4251.00.00</b>	Spona upravljača Drag link Lenkstange Izmenjivi delovi Parts list Stuckliste 7720.20.00	40	K31.5	940  RØ42	
<b>1 581 527</b> 1 607 079 8 154 017 8 158 206 8 158 207	<b>5594.00.00</b>	Vođica mosta Torque rod Achsstrebe Izmenjivi delovi Parts list Stuckliste 5594.96.00	70	Ø21 >30< <130>	660  RØ50	
<b>1 588 263</b> 1 606 277 1 626 493	<b>6734.00.00</b>	Spona upravljača Drag link Lenkstange Izmenjivi delovi Parts list Stuckliste 7720.20.00	40	K31.5	710  RØ42	
<b>1 589 817</b>	<b>5584.00.00</b>	Vođica mosta Torque rod Achsstrebe Izmenjivi delovi Parts list Stuckliste 5581.90.00	91	Ø14 >20< <125>	666  RØ58	
<b>1 592 939</b> 85 114 144	<b>3075.00.00</b>	Spona upravljača Drag link Lenkstange  Izmenjivi delovi Parts list Stuckliste 7720.20.00	40	K31.5	795  RØ50	
<b>1 592 940</b> 85 114 145	<b>4223.00.00</b>	Spona upravljača Drag link Lenkstange  Izmenjivi delovi Parts list Stuckliste 7720.20.00	40	K31.5	800  RØ52	



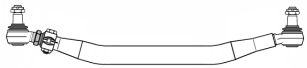
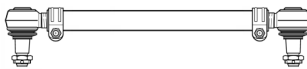
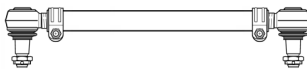
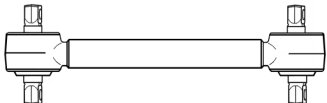
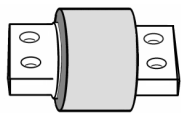
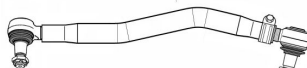

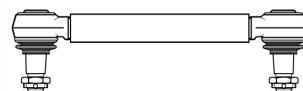
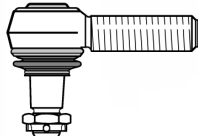
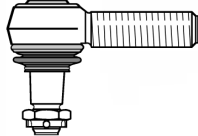
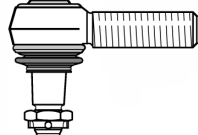
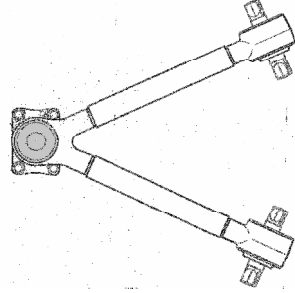

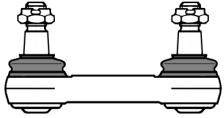
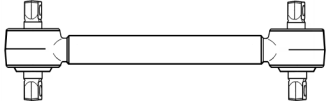
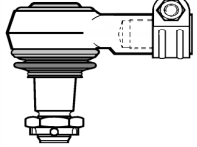

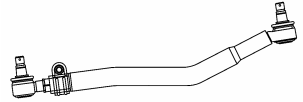
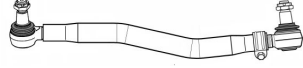

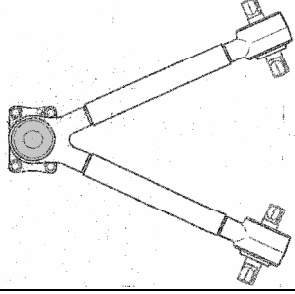
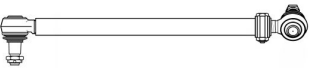
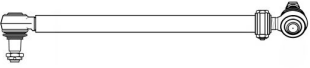
Originalni broj Cross-Ref.-No. Original Nr.	Br. FAD No. No.	Naziv Designation Bezeichnung	Kugla Ball Ø Größe	Konus Taper Konus	Dužina Length Länge	Skica Figure Bild
<b>1 598 588</b>	<b>5581.90.00</b>	Izmenjivi podsklop Repair kit Reparatur satz	91	Ø14	<125>	
<b>1 599 175</b> 1 613 351 1 626 671	<b>4245.00.00</b>	Spona upravljača Drag link Lenkstange  Izmenjivi delovi Parts list Stuckliste 7720.20.00	40	K31.5	1779 RØ60	
<b>1 606 551</b> 8 154 016	<b>5598.00.00</b>	Vođica mosta Torque rod Achsstrebe  Izmenjivi delovi Parts list Stuckliste 5581.96.00	62	Ø21 >24< <130>	660 RØ50	
<b>1 608 351</b>	<b>6750.20.00</b>	Zglob, RH 38x1.5 Ball joint, RH Kugelgelenk, RH	53	Ø20 >24<	150 <102>	
<b>1 608 352</b>	<b>6750.10.00</b>	Zglob, LH 38x1.5 Ball joint, LH Kugelgelenk, LH	53	Ø20 >24<	150 <102>	
<b>1 610 338</b> 1 626 751	<b>5595.00.00</b>	Spona upravljača Drag link Lenkstange  Izmenjivi delovi Parts list Stuckliste 7720.20.00	40	K31.5	850 RØ42	
<b>1 611 880</b> 1 626 670	<b>4212.00.00</b>	Spona upravljača Drag link Lenkstange  Izmenjivi delovi Parts list Stuckliste 7720.20.00	40	K31.5	824 RØ42	

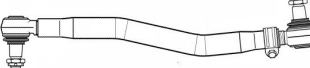
Originalni broj Cross-Ref.-No. Original Nr.	Br. FAD No. Nr.	Naziv Designation Bezeichnung	Kugla Ball Ø Größe	Konus Taper Konus	Dužina Length Länge	Skica Figure Bild
<b>1 612 254</b> 20 393 097 21 260 286 3 985 570	<b>6746.00.00</b>	Poprečna spona Tie rod Spurstange  Izmenjivi delovi Parts list Stuckliste 4222.20.00	40	K28.6	1640  RØ60	
<b>1 626 494</b>	<b>5136.00.00</b>	Poprečna spona Tie rod Spurstange Izmenjivi delovi Parts list Stuckliste 3546.10.00 3546.20.00	40	K28.6	1592  RØ40	
<b>1 626 637</b> 3 962 343 3 988 711	<b>6769.00.00</b>	Poprečna spona Tie rod Spurstange Izmenjivi delovi Parts list Stuckliste 5596.10.00 5596.20.00	35	K28.6	1645  RØ42	
<b>1 626 957</b>	<b>4258.00.00</b>	Vodica mosta Torque rod Achsstrebe  Izmenjivi delovi Parts list Stuckliste 5594.96.00	70	Ø21 >30< <130>	571  RØ50	
<b>1 628 107</b>	<b>5586.90.00</b>	Izmenjivi podsklop Repair kit Reparatur satz	91	Ø15	<145>	
<b>1 628 635</b> 3 988 708 3 988 710 20 393 079	<b>4248.00.00</b>	Spona upravljača Drag link Lenkstange  Izmenjivi delovi Parts list Stuckliste 3546.20.00	40	K28.6	869  RØ52	

Originalni broj Cross-Ref.-No. Original Nr.	Br. FAD No. No.	Naziv Designation Bezeichnung	Kugla Ball Ø Größe	Konus Taper Konus	Dužina Length Länge	Skica Figure Bild
<b>1 628 636</b> 85 114 200	<b>5596.00.00</b>	Spona upravljača Drag link Lenkstange  Izmenjivi delovi Parts list Stuckliste 3546.20.00	40	K28.6	880  RØ52	
<b>1 629 668</b> 3 986 433	<b>4225.00.00</b>	Stabilizator Stabilizer link Koppelstang	30	K22	325  RØ30	
<b>1 695 840</b>	<b>7720.10.00</b>	Zglob,LH M30x1.5 Ball joint, LH Kugelgelenk, LH	40	K31.5	120	
<b>1 696 920</b>	<b>4746.20.00</b>	Zglob,RH M24x1,5 Ball joint, RH Kugelgelenk, RH	30	K22	105	
<b>1 697 246</b> 1 698 047	<b>4208.20.00</b>	Zglob, RH 30x1.5 Ball joint, RH Kugelgelenk, RH	40	K30	120	
<b>20 367 004</b> 20 507 262 20 741 695 20 741 703 7420 741 703	<b>6720.00.00</b>	V-Vođica mosta Torque rod Achsstrebe  Izmenjivi delovi Parts list Stuckliste 5521.96.00	65/62	Ø19 >24< <115> K38	663  RØ50	

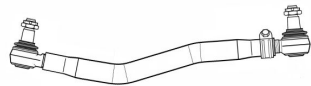
Originalni broj Cross-Ref.-No. Original Nr.	Br. FAD No. No.	Naziv Designation Bezeichnung	Kugla Ball Ø Größe	Konus Taper Konus	Dužina Length Länge	Skica Figure Bild
<b>20 367 555</b>	<b>4262.00.00</b>	Stabilizator Stabilizer link Koppelstang	35	K28,6	160 RØ32	
<b>20 374 444</b> 20 410 530 20 509 018	<b>6284.00.00</b>	Vođica mosta Torque rod Achsstrebe  Izmenjivi delovi Parts list Stuckliste 6271.90.00	70	Ø17 >24< <115>	625 RØ50	
<b>20 374 698</b>	<b>4241.20.00</b>	Zglob,RH 26x1.5* Ball joint, RH Kugelgelenk, RH	40	K28.6	88	
<b>20 374 831</b> 21 252 480	<b>6267.00.00</b>	Spona upravljača Drag link Lenkstange  Izmenjivi delovi Parts list Stuckliste 3546.20.00	40	K28.6	563 RØ50	
<b>20 375 555</b> 20 393 186 21 106 930 3 986 452	<b>6276.00.00</b>	Spona upravljača Drag link Lenkstange  Izmenjivi delovi Parts list Stuckliste 3546.20.00	40	K28.6	863 RØ52	
<b>20 375 787</b> 21 106 933	<b>5596.00.00</b>	Spona upravljača Drag link Lenkstange  Izmenjivi delovi Parts list Stuckliste 4233.20.00	40	K28.6	824 RØ50	

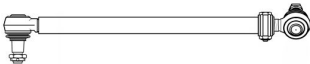

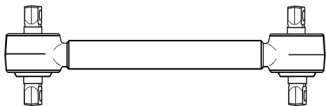
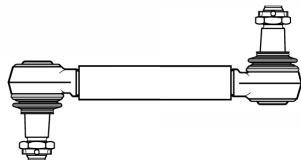
Originalni broj Cross-Ref.-No. Original Nr.	Br. FAD No. Nr.	Naziv Designation Bezeichnung	Kugla Ball Ø Größe	Konus Taper Konus	Dužina Length Länge	Skica Figure Bild
<b>20 382 314</b> <b>20 502 944</b>	<b>6721.00.00</b>	V-Vođica mosta Torque rod Achsstrebe  Izmenjivi delovi Parts list Stuckliste 6721.96.00	65/62	Ø19 >24< <115> K38	649  RØ50	
<b>20 383 080</b> <b>21 252 481</b>	<b>4265.00.00</b>	Poprečna spona Tie rod Spurstange Izmenjivi delovi Parts list Stuckliste 4233.20.00	40	K28.6	1025  RØ50	
<b>20 383 081</b> 21 260 283	<b>4266.00.00</b>	Spona upravljača Drag link Lenkstange Izmenjivi delovi Parts list Stuckliste 4233.20.00	40	K28.6	485  RØ50	
<b>20 390 745</b> 21 106 936	<b>6726.00.00</b>	Spona upravljača Drag link Lenkstange Izmenjivi delovi Parts list Stuckliste 3546.20.00	40	K28.6	885  RØ50	
<b>20 393 061</b> 3 988 697	<b>6747.00.00</b>	Spona upravljača Drag link Lenkstange Izmenjivi delovi Parts list Stuckliste 3546.20.00	40	K28.6	881  RØ52	
<b>20 393 071</b> 8 190 146	<b>4220.00.00</b>	Spona upravljača Drag link Lenkstange Izmenjivi delovi Parts list Stuckliste 5596.20.00	35	K28.6	881  RØ52	

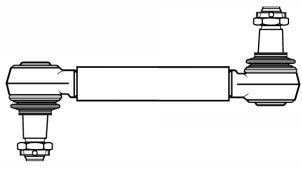
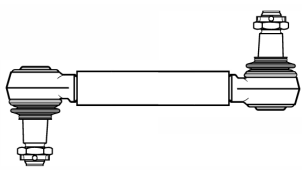
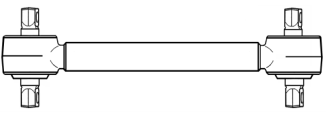
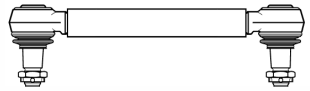
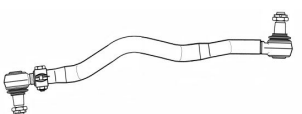
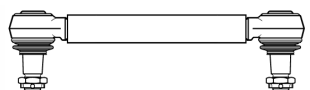
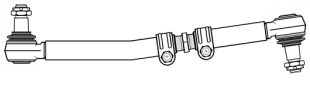

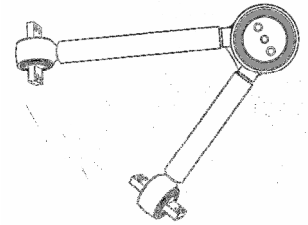
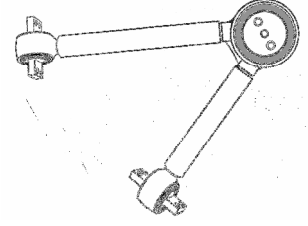
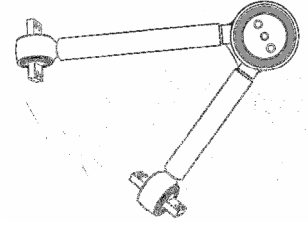
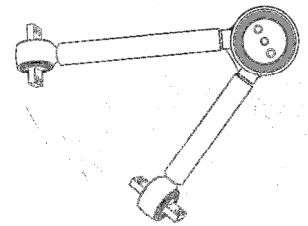
Originalni broj Cross-Ref.-No. Original Nr.	Br. FAD No. Nr.	Naziv Designation Bezeichnung	Kugla Ball Ø Größe	Konus Taper Konus	Dužina Length Länge	Skica Figure Bild
<b>20 393 091</b> 20 442 113 20 513 951 24 425 660	<b>6278.00.00</b>	Spona upravljača Drag link Lenkstange  Izmenjivi delovi Parts list Stuckliste 6278.20.00	35	K28.6	2090  RØ52	
<b>20 393 187</b> 21 406 952	<b>6268.00.00</b>	Spona upravljača Drag link Lenkstange  Izmenjivi delovi Parts list Stuckliste 4233.20.00	40	K28.6	863  RØ52	
<b>20 400 909</b> 3 124 480 3 124 594 6 777 855	<b>4229.00.00</b>	Spona upravljača Drag link Lenkstange  Izmenjivi delovi Parts list Stuckliste 4746.20.00	30	K22	978  RØ30	
<b>20 400 942</b> 6 790 607 6 790 766	<b>4244.00.00</b>	Spona upravljača Drag link Lenkstange  Izmenjivi delovi Parts list Stuckliste 5741.20.00	35	K26	871  RØ42	
<b>20 410 053</b> 21 106 157	<b>4259.00.00</b>	Vodica mosta Torque rod Achsstrebe  Izmenjivi delovi Parts list Stuckliste 5323.96.00	62	Ø17 >24< <115>	799  RØ50	
<b>20 443 061</b> 20 443 065 20 994 18	<b>6266.00.00</b>	Stabilizator Stabillizer link Koppelstang	40	K28.6	435  RØ36	

Originalni broj Cross-Ref.-No. Original Nr.	Br. FAD No. Nr.	Naziv Designation Bezeichnung	Kugla Ball Ø Größe	Konus Taper Konus	Dužina Length Länge	Skica Figure Bild
<b>20 443 062</b> 20 443 066 20 994 419	<b>6275.00.00</b>	Stabilizator Stabillizer link Koppelstang	40	K28.6	380 RØ36	
<b>20 443 063</b> 20 443 067 20 994 420	<b>6262.00.00</b>	Stabilizator Stabillizer link Koppelstang	40	K28.6	350 RØ36	
<b>20 453 123</b>	<b>4264.00.00</b>	Vođica mosta Torque rod Achsstrebe  Izmenjivi delovi Parts list Stuckliste 5323.96.00	62	Ø17 >24< <115>	449 RØ50	
<b>20 477 807</b> 3 944 046	<b>4263.00.00</b>	Stabilizator Stabillizer link Koppelstang	30	K22	340 RØ30	
<b>20 490 123</b> 20 745 923 21 308 022 9 519 278	<b>5494.00.00</b>	Spona upravljača Drag link Lenkstange  Izmenjivi delovi Parts list Stuckliste 5494.20.00	40	K28.8	1025 RØ60	
<b>20 497 798</b> 3 112 050 9 959 151	<b>6261.00.00</b>	Stabilizator Stabillizer link Koppelstang	40	K28.6	300 RØ30	
<b>20 497 799</b> 3 112 273 9 959 152	<b>6263.00.00</b>	Poprečna spona Tie rod Spurstange	40	K28.6	743 RØ40	

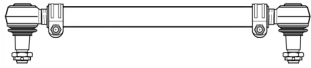
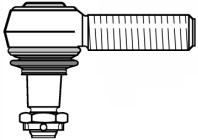
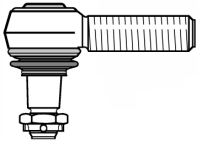
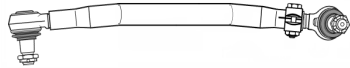

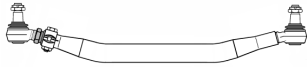

Originalni broj Cross-Ref.-No. Original Nr.	Br. FAD No. Nr.	Naziv Designation Bezeichnung	Kugla Ball Ø Größe	Konus Taper Konus	Dužina Length Länge	Skica Figure Bild
<b>20 497 800</b> 3 112 122 9 959 153	<b>6731.00.00</b>	Spona upravljača Drag link Lenkstange  Izmenjivi delovi Parts list Stuckliste 5596.20.00	35	K28.6	763  RØ40	
<b>20 556 490</b> 3 173 291	<b>6723.00.00</b>	V-Vođica mosta Triangular torque rod Dreieckslenker Izmenjivi delovi  Parts list Stuckliste 5580.90.00 5586.90.00	137/91	Ø15 >26< <145> K87	677  RØ58	
<b>20 556 491</b> 3 173 292	<b>6761.00.00</b>	V-Vođica mosta Triangular torque rod Dreieckslenker  Izmenjivi delovi Parts list Stuckliste 5580.90.00 5586.90.00	137/91	Ø15 >26< <145> K87	680  RØ58	
<b>20 556 492</b> 3 173 293	<b>6737.00.00</b>	V-Vođica mosta Triangular torque rod Dreieckslenker  Izmenjivi delovi Parts list Stuckliste 5580.90.00 5586.90.00	137/91	Ø15 >26< <145> K87	655  RØ58	
<b>20 556 586</b> 3 173 294	<b>6738.00.00</b>	V-Vođica mosta Triangular torque rod Dreieckslenker  Izmenjivi delovi Parts list Stuckliste 5580.90.00 5586.90.00	137/91	Ø14 >20< <125> K87	685  RØ58	

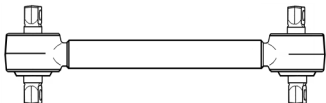
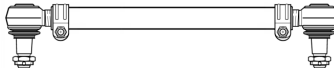
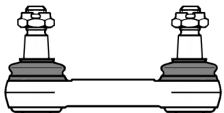

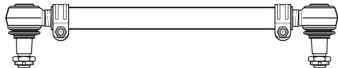
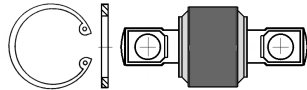
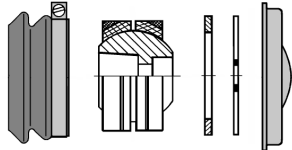
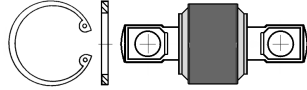
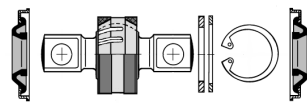
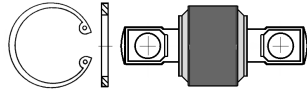
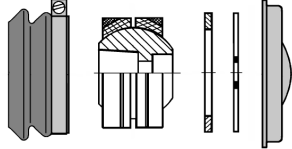
Originalni broj Cross-Ref.-No. Original Nr.	Br. FAD No. Nr.	Naziv Designation Bezeichnung	Kugla Ball Ø Größe	Konus Taper Konus	Dužina Length Länge	Skica Figure Bild
<b>20 581 086</b>	<b>4234.00.00</b>	Poprečna spona Tie rod Spurstange  Izmenjivi delovi Parts list Stuckliste 4234.10.00 4234.20.00	40	K32	1669  RØ42	
<b>20 581 089</b>	<b>4234.20.00</b>	Zglob,RH M30x1.5 Ball joint, RH Kugelgelenk, RH	40	K32	135	
<b>20 710 008</b>	<b>4234.10.00</b>	Zglob,LH M30x1.5 Ball joint, LH Kugelgelenk, LH	40	K32	135	
<b>20 727 840</b>	<b>4693.00.00</b>	Spona upravljača Drag link Lenkstange  Izmenjivi delovi Parts list Stuckliste 4706.20.00	40	K30	880  RØ62	
<b>20 739 082</b> 70 311 664	<b>6260.00.00</b>	Spona upravljača Drag link Lenkstange	35	K28.6	1243  RØ40	
<b>20 818 854</b>	<b>4712.00.00</b>	Spona upravljača Drag link Lenkstange  Izmenjivi delovi Parts list Stuckliste 4712.20.00	40	K30	900  RØ50	

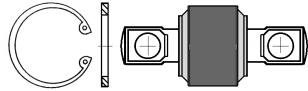
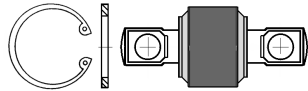
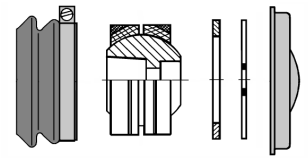

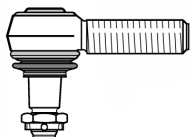
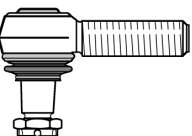
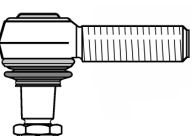

Originalni broj Cross-Ref.-No. Original Nr.	Br. FAD No. Nr.	Naziv Designation Bezeichnung	Kugla Ball Ø Größe	Konus Taper Konus	Dužina Length Länge	Skica Figure Bild
<b>21 260 274</b> 3 198 276	<b>6727.00.00</b>	Poprečna spona Tie rod Spurstange  Izmenjivi delovi Parts list Stuckliste 4222.20.00	40	K28.6	1634  RØ50	
<b>21 260 275</b> 3 198 234	<b>6728.00.00</b>	Poprečna spona Tie rod Spurstange  Izmenjivi delovi Parts list Stuckliste 4222.20.00	40	K28.6	1660  RØ60	
<b>21 426 652</b> 70 311 662 85 115 635	<b>6274.00.00</b>	Spona upravljača Drag link Lenkstange  Izmenjivi delovi Parts list Stuckliste 4233.20.00	40	K28.6	1728  RØ50	
<b>21 461 309</b> 70 371 272	<b>6283.00.00</b>	Vođica mosta Torque rod Achsstrebe  Izmenjivi delovi Parts list Stuckliste 6271.90.00	70	Ø17 >24< <115>	444  RØ50	
<b>21 560 965</b> 25 370 844 74 21 560 965	<b>4733.00.00</b>	Poprečna spona Tie rod Spurstange  Izmenjivi delovi Parts list Stuckliste 6321.10.00 4563.20.00	40	K30	1719  RØ40	
<b>24 425 411</b>	<b>6272.00.00</b>	Stabilizator Stabilizer link Koppelstang	40	K30	160  RØ32	

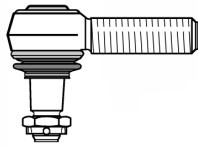
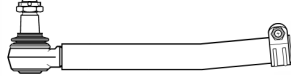
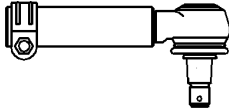
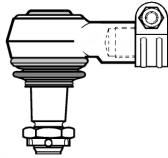
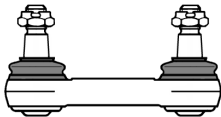
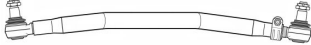
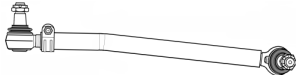

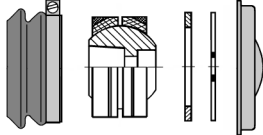
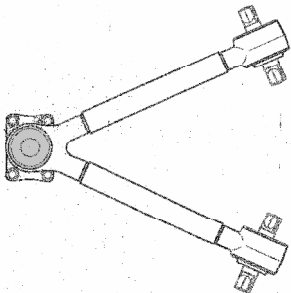
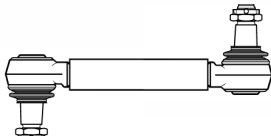
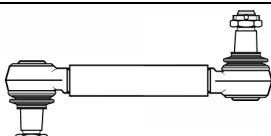
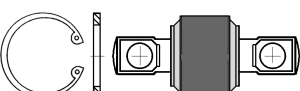
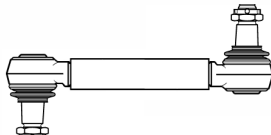
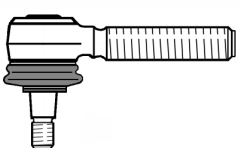
Originalni broj Cross-Ref.-No. Original Nr.	Br. FAD No. No.	Naziv Designation Bezeichnung	Kugla Ball Ø Größe	Konus Taper Konus	Dužina Length Länge	Skica Figure Bild
<b>25 370 845</b>	<b>4710.00.00</b>	Spona upravljača Drag link Lenkstange Izmenjivi delovi Parts list Stuckliste 5743.20.00 5743.10.00	40	K30	1676  RØ40	
<b>271 187</b>	<b>5323.96.00</b>	Izmenjivi podsklop Repair kit Reparatur satz	62	Ø17 >24<	<115>	
<b>271 188</b>	<b>5121.90.00</b>	Izmenjivi podsklop Repair kit Reparatur satz	65	K38		
<b>273 373</b> 274 019 4 941 233	<b>5594.96.00</b>	Izmenjivi podsklop Repair kit Reparatur satz	70	Ø21 >30<	<130>	
<b>273 375</b>	<b>5945.90.00</b>	Izmenjivi podsklop Repair kit Reparatur satz	80	Ø23 >35<	<152>	
<b>273 612</b>	<b>5386.96.00</b>	Izmenjivi podsklop Repair kit Reparatur satz	78.5	Ø21 >35<	<130>	
<b>273 706</b>	<b>5943.90.00</b>	Izmenjivi podsklop Repair kit Reparatur satz	80	K46		

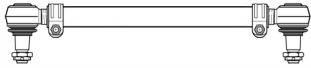
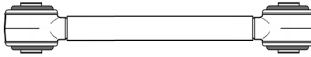
Originalni broj Cross-Ref.-No. Original Nr.	Br. FAD No. Nr.	Naziv Designation Bezeichnung	Kugla Ball Ø Größe	Konus Taper Konus	Dužina Length Länge	Skica Figure Bild
<b>274 056</b> 276 192	<b>5587.96.00</b>	Izmenjivi podsklop Repair kit Reparatur satz	78.5	Ø23 >35<	<152>	
<b>274 068</b>	<b>3744.96.00</b>	Izmenjivi podsklop Repair kit Reparatur satz	70	Ø21 >24<	<152>	
<b>274 069</b>	<b>5589.90.00</b>	Izmenjivi podsklop Repair kit Reparatur satz	65	K42		
<b>3 039 647</b>	<b>4211.00.00</b>	Spona upravljača Drag link Lenkstange  Izmenjivi delovi Parts list Stuckliste 5741.20.00	35	K26	1030  RØ42	
<b>3 090 727</b> 3 092 472 3 988 965	<b>5596.20.00</b>	Zglob,RH M30x1.5 Ball joint, RH Kugelgelenk, RH	35	K28.6	115	
<b>3 090 728</b> 3 110 001 3 988 968	<b>5596.10.00</b>	Zglob,LH M30x1.5 Ball joint, LH Kugelgelenk, LH	35	K28.6	115	
<b>3 093 647</b>	<b>4233.20.00</b>	Zglob,RH M30x1.5 Ball joint, RH Kugelgelenk, RH	40	K28.6	141	
<b>3 097 228</b> 3 099 529	<b>4222.20.00</b>	Zglob,RH M30x1,5 Ball joint, RH Kugelgelenk, RH	40	K28.6	140	

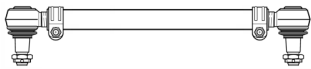
Originalni broj Cross-Ref.-No. Original Nr.	Br. FAD No. Nr.	Naziv Designation Bezeichnung	Kugla Ball Ø Größe	Konus Taper Konus	Dužina Length Länge	Skica Figure Bild
<b>3 097 999</b> 85 104 188	<b>5494.20.00</b>	Zglob,RH M20x1.5 Ball joint, RH Kugelgelenk, RH	40	K28.8	120	
<b>3 098 294</b> 85 104 265	<b>6748.00.00</b>	Spona upravljača Drag link Lenkstange	40	K28.6	495 RØ40	
<b>3 098 295</b> 85 104 266	<b>6263.10.00</b>	Zglob,RH 28x1.5* Ball joint, RH Kugelgelenk, RH	40	K28.6	202	
<b>3 099 129</b>	<b>4163.20.00</b>	Zglob, RH M30x1,5 * Ball joint, RH Kugelgelenk, RH	50	K38	86	
<b>3 112 282</b>	<b>6281.00.00</b>	Stabilizator Stabilizer link Koppelstang	40	K30	220 RØ32	
<b>3 116 050</b>	<b>4209.00.00</b>	Poprečna spona Tie rod Spurstange Izmenjivi delovi Parts list Stuckliste 7720.20.00	40	K31.5	1820 RØ50	
<b>3 124 964</b> 6 799 190	<b>4208.00.00</b>	Spona upravljača Drag link Lenkstange  Izmenjivi delovi Parts list Stuckliste 4208.20.00	40	K30	885 RØ40	

Originalni broj Cross-Ref.-No. Original Nr.	Br. FAD No. Nr.	Naziv Designation Bezeichnung	Kugla Ball Ø Größe	Konus Taper Konus	Dužina Length Länge	Skica Figure Bild
<b>3 133 173</b>	<b>5524.90.00</b>	Izmenjivi podsklop Repair kit Reparatur satz	65	K38		
<b>3 172 829</b>	<b>6744.00.00</b>	V-Vođica mosta Triangular torque rod Dreieckslenker  Izmenjivi delovi Parts list Stuckliste 5121.90.00 6721.96.00	65	Ø17 Ø19.5 <24> K38	680  RØ48	
<b>3 173 613</b> 3 987 354	<b>4218.00.00</b>	Stabilizator Stabillizer link Koppelstang	40	K28.6	440  RØ36	
<b>3 173 614</b>	<b>4232.00.00</b>	Stabilizator Stabillizer link Koppelstang	40	K28.6	380  RØ36	
<b>3 198 309</b>	<b>4490.96.00</b>	Izmenjivi podsklop Repair kit Reparatur satz	90	Ø25 >24<	<152>	
<b>3 962 843</b>	<b>4200.00.00</b>	Stabilizator Stabillizer link Koppelstang	50	K38	325  RØ40	
<b>6 027 074</b> 6 853 913	<b>3590.20.00</b>	Zglob,RH M14x1,5 Ball joint, RH Kugelgelenk, RH	22	K12	85	

Originalni broj Cross-Ref.-No. Original Nr.	Br. FAD No. Nr.	Naziv Designation Bezeichnung	Kugla Ball Ø Größe	Konus Taper Konus	Dužina Length Länge	Skica Figure Bild
<b>6 771 112</b>	<b>5140.00.00</b>	Poprečna spona Tie rod Spurstange Izmenjivi delovi Parts list Stuckliste 5741.10.00 5741.20.00	35	K26	1582  RØ40	
<b>6 777 705</b>	<b>4240.00.00</b>	Vodica mosta Torque rod Achsstrebe Izmenjivi delovi Parts list Stuckliste 5554.20.00	40	Ø20	510  RØ40	
<b>6 790 572</b>	<b>6739.00.00</b>	Spona upravljača Drag link Lenkstange Izmenjivi delovi Parts list Stuckliste 5741.20.00	35	K26	871  RØ42	
<b>6 799 189</b>	<b>4260.00.00</b>	Spona upravljača Drag link Lenkstange  Izmenjivi delovi Parts list Stuckliste 4208.20.00	40	K30	893  RØ40	
<b>6 853 511</b>	<b>6767.00.00</b>	Poprečna spona Tie rod Spurstange Izmenjivi delovi Parts list Stuckliste 5746.10.00 5746.20.00	30	K22	1407  RØ36	
<b>70 311 665</b>	<b>6273.00.00</b>	Spona upravljača Drag link Lenkstange Izmenjivi delovi Parts list Stuckliste 5596.20.00	35	K28.6	793  RØ42	

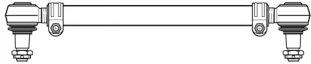
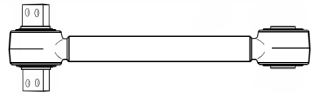
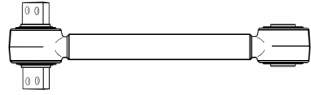
Originalni broj Cross-Ref.-No. Original Nr.	Br. FAD No. Nr.	Naziv Designation Bezeichnung	Kugla Ball Ø Größe	Konus Taper Konus	Dužina Length Länge	Skica Figure Bild
<b>8 132 373</b>	<b>4210.00.00</b>	Spona upravljača Drag link Lenkstange  Izmenjivi delovi Parts list Stuckliste 7720.20.00	40	K31.5	1022  RØ60	
<b>8 154 444</b>	<b>6730.00.00</b>	Spona upravljača Drag link Lenkstange  Izmenjivi delovi Parts list Stuckliste 7720.20.00	40	K31.5	934  RØ50	
<b>8 156 123</b>	<b>6754.00.00</b>	Poprečna spona Tie rod Spurstange  Izmenjivi delovi Parts list Stuckliste 5596.10.00 5596.20.00	35	K28.6	1674  RØ42	
<b>8 190 034</b>	<b>4257.00.00</b>	Vođica mosta Torque rod Achsstrebe  Izmenjivi delovi Parts list Stuckliste 5581.90.00 5597.90.00	91	Ø14 >20< <125>	566  RØ58	
<b>9 523 794</b>	<b>6759.00.00</b>	Vođica mosta Torque rod Achsstrebe  Izmenjivi delovi Parts list Stuckliste 5581.90.00 5597.90.00	91	Ø14 >20< <125>	535  RØ60	

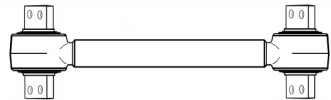
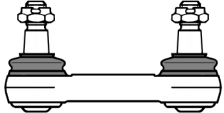

Originalni broj Cross-Ref.-No. Original Nr.	Br. FAD No. No. Nr.	Naziv Designation Bezeichnung	Kugla Ball Ø Größe	Konus Taper Konus	Dužina Length Länge	Skica Figure Bild
<b>9 523 795</b>	<b>6755.00.00</b>	Vođica mosta Torque rod Achsstrebe  Izmenjivi delovi Parts list Stuckliste 5581.90.00	91	Ø14 >20< <125>	535  RØ58	
<b>9 959 503</b>	<b>4237.00.00</b>	Stabilizator Stabilizer link Koppelstang	40	K31,5	150  RØ32	

**Pregled uporednih oznaka  
OEM / FAD**

**Cross references  
OEM / FAD**

OEM	FAD	OEM	FAD	OEM	FAD
0 067 354	5117.96.00	0 696 225	5743.10.00	1 351 735	6793.00.00
0 069 867	5742.20.00	0 696 226	5810.20.00	1 351 737	6815.00.00
0 080 521	3873.00.00	0 696 600	3875.90.00	1 351 741	6794.00.00
0 080 521	6770.00.00	0 698 450	5743.20.00	1 351 743	6987.00.00
0 094 016	5394.00.00	0 698 609	5741.20.00	1 353 391	6777.00.00
0 094 029	5393.00.00	0 698 724	3873.96.00	1 353 394	6780.00.00
0 094 038	5392.00.00	080 521	3873.00.00	1 353 395	6825.00.00
0 094 044	3889.00.00	0 817 824	7474.20.00	1 361 155	6786.00.00
0 099 990	5385.00.00	099 900	5385.00.00	1 361 650	5398.00.00
0 110 197	5746.20.00	1 142 173	5742.20.00	1 361 652	3877.00.00
0 117 343	5393.00.00	1 143 324	6781.00.00	1 363 858	6787.00.00
0 161 376	5742.20.00	1 152 427	3889.00.00	1 363 859	6814.00.00
0 171 215	5394.00.00	1 191 900	6781.00.00	1 368 270	6770.00.00
0 267 743	5398.00.00	1 228 114	5746.20.00	1 376 729	6771.96.00
0 273 203	3142.20.00	1 228 115	5743.10.00	1 380 417	6821.00.00
0 274 878	3889.00.00	1 229 944	5741.20.00	1 385 487	6794.00.00
0 513 757	5594.96.00	1 243 618	6409.96.00	1 385 490	6773.00.00
0 516 089	3965.20.00	1 257 890	5743.20.00	1 385 492	5389.00.00
0 525 433	5392.00.00	1 257 991	6782.00.00	1 385 493	6782.00.00
0 586 714	5810.20.00	1 257 992	6773.00.00	1 385 494	6987.00.00
0 586 753	5741.20.00	1 261 101	5387.00.00	1 385 497	6784.00.00
0 589 943	6795.00.00	1 270 853	6777.00.00	1 385 498	6815.00.00
0 607 053	5743.10.00	1 270 854	6817.00.00	1 385 499	3879.00.00
0 607 073	5810.20.00	1 271 124	5959.90.00	1 385 500	6793.00.00
0 607 451	5746.20.00	1 271 125	4163.20.00	1 385 506	6783.00.00
0 607 452	5746.10.00	1 283 211	6784.00.00	1 390 932	6770.00.00
0 607 453	5746.20.00	1 283 212	5389.00.00	1 395 994	6796.00.00
0 607 981	5743.20.00	1 284 860	5399.00.00	1 398 368	6770.90.00
0 607 998	5741.10.00	1 290 321	6780.00.00	1 399 724	3142.20.00
0 607 999	5741.20.00	1 291 048	6793.00.00	1 395 993	6986.00.00
0 608 000	5742.20.00	1 291 060	3879.00.00	1 400 156	4471.00.00
0 608 530	5805.20.00	1 294 251	6816.00.00	1 405 309	6981.00.00
0 609 634	5810.20.00	1 297 572	6786.00.00	1 405 363	6826.00.00
0 609 643	5810.20.00	1 306 333	6794.00.00	1 405 655	6812.00.00
0 646 373	5399.00.00	1 311 048	6815.00.00	1 405 823	4471.00.00
0 649 819	3876.00.00	1 315 530	6783.00.00	1 406 025	6812.00.00
0 655 695	5399.00.00	1 320 855	3903.20.00	1 406 038	6823.00.00
0 655 697	5399.00.00	1 321 170	6987.00.00	1 407 144	6812.00.00
0 658 104	6772.00.00	1 321 936	5128.96.00	1 407 963	4471.00.00
0 661 406	5386.00.00	1 331 925	5741.20.00	1 408 040	6827.00.00
0 661 407	5386.00.00	1 337 644	6817.00.00	1 426 101	6829.00.00
0 689 747	5847.96.00	1 342 026	3903.20.00	1 426 375	6985.00.00
0 689 748	5323.96.00	1 344 684	6795.20.00	1 448 062	6787.00.00
0 689 749	5170.96.00	1 351 205	6825.00.00	1 448 063	6814.00.00
0 691 703	3744.96.00	1 351 714	6784.00.00	1 451 118	6982.00.00
0 691 704	5121.90.00	1 351 715	5389.00.00	1 451 119	6983.00.00
0 691 709	5594.96.00	1 351 718	6782.00.00	1 451 122	6828.00.00
0 693 778	3755.90.00	1 351 731	6783.00.00	1 451 126	6985.00.00
0 694 298	5741.20.00	1 351 732	6773.00.00	1 451 129	6821.00.00
0 694 360	5741.20.00	1 351 734	3879.00.00	1 602 820	6820.00.00



OEM	FAD		OEM	FAD		OEM	FAD
0813 7026	5120.00.00		4102 8600	5120.00.00		4248 4886	5746.20.00
0928 1792	7474.20.00		4103 4479	5120.00.00		4248 4887	5746.10.00
247 5843	6364.00.00		4103 6943	6418.00.00		4248 7165	4746.20.00
248 3652	5094.00.00		4103 6944	6439.00.00		4248 8269	5743.20.00
252 0334	5094.00.00		4104 2050	5120.00.00		4248 8722	5170.96.00
252 0336	5095.00.00		4104 2730	6439.00.00		4248 9395	5743.10.00
296 6252	5743.20.00		4104 2749	6434.00.00		4248 9573	5743.20.00
296 6321	5746.20.00		4120 3863	6432.20.00		4248 9594	5743.20.00
296 6635	5746.20.00		4121 4657	6415.00.00		4249 1638	5743.20.00
296 8454	5121.90.00		4129 8449	6430.00.00		4249 1937	5805.20.00
296 9507	5746.10.00		4200 0481	5104.00.00		4249 1957	5743.10.00
296 9808	5743.20.00		4200 0486	5097.00.00		4249 3431	3765.96.00
298 0129	5741.10.00		4200 1325	5118.00.00		4249 3781	5741.20.00
298 0323	5741.20.00		4200 1326	5118.00.00		4249 3782	5741.10.00
298 0875	5742.20.00		4200 3432	6403.00.00		4253 0316	4163.20.00
298 0884	5959.90.00		4201 4656	6364.00.00		4253 2294	6107.20.00
298 4061	5743.10.00		4201 9062	5108.00.00		4253 2543	5805.10.00
298 4511	5741.10.00		4202 6837	6364.00.00		4253 3101	6425.20.00
343 57 86	3590.20.00		4202 6840	6364.00.00		4253 3102	6425.20.00
343 57 88	3567.20.00		4203 2936	5094.00.00		4253 8047	4163.20.00
4 018 036	5391.20.00		4203 2938	5095.00.00		445 7748	3559.00.00
4 018 037	5391.10.00		4203 4051	5097.00.00		445 7748	5111.00.00
4 103 2608	6424.00.00		4203 4054	5104.00.00		466 3787	3203.20.00
4 103 3237	6424.00.00		4203 7386	6359.00.00		468 8941	5122.20.00
4 121 5165	5149.00.00		4203 7655	6364.00.00		468 8948	5856.20.00
4 121 5165	6423.00.00		4203 7657	6364.00.00		468 8949	5856.10.00
4 663 787	5391.20.00		4204 1107	5105.00.00		471 1108	5143.00.00
4 663 791	5391.10.00		4204 1327	6432.20.00		471 1109	5143.00.00
4100 2118	6432.20.00		4204 2431	5096.00.00		471 4134	5081.00.00
4100 2770	5120.00.00		4204 2912	3567.20.00		471 4134	5114.00.00
4100 5309	6405.00.00		4204 2950	5144.00.00		471 6271	5121.00.00
4100 5450	6439.00.00		4204 3912	5144.00.00		471 6799	5126.00.00
4100 5451	6439.00.00		4205 5474	5107.00.00		471 9609	5116.00.00
4100 5460	6405.00.00		4206 5332	5106.00.00		474 1171	6399.00.00
4100 5463	5119.00.00		4207 9853	6432.20.00		474 7960	5113.00.00
4100 5466	6398.00.00		4208 6458	5118.00.00		474 7961	5113.00.00
4100 5469	6414.00.00		4208 7842	5113.00.00		477 3359	5122.00.00
4100 5475	6422.00.00		4210 5474	6107.20.00		480 2443	5743.20.00
4100 6093	6422.00.00		4212 5057	5081.00.00		480 2444	5743.10.00
4100 9665	5120.00.00		4212 5057	5114.00.00		483 3821	5741.10.00
4100 9961	6441.00.00		4220 0700	3537.00.00		483 3825	5746.20.00
4101 1006	5106.00.00		4220 4475	3537.00.00		483 3826	5741.10.00
4101 1476	6414.00.00		4221 1146	3537.00.00		483 3826	5746.10.00
4101 6960	6414.00.00		4221 1148	3537.00.00		483 3828	5741.10.00
4101 6961	6414.00.00		4248 0023	5805.10.00		483 3829	5743.20.00
4101 6964	6398.00.00		4248 0024	5805.20.00		483 3830	5743.10.00
4102 8269	6430.00.00		4248 3386	5743.20.00		483 4037	5122.00.00
4102 8598	5120.00.00		4248 3520	5741.20.00		485 4871	6404.00.00

OEM	FAD		OEM	FAD
485 4874	5123.00.00		8601 2923	6359.00.00
486 8942	5122.10.00		8602 7074	3590.20.00
500 307 556	6402.00.00		928 1792	7474.20.00
500 324 282	6429.00.00		9316 1631	5120.90.00
500 333 284	4569.96.00		9316 1638	5120.90.00
500 336 085	6433.00.00		9316 1958	6436.90.00
500 338 783	6442.00.00		9315 7156	4163.20.00
504 034 521	6438.00.00		9316 3617	5128.96.00
504 049 893	6435.00.00		9319 1941	3559.00.00
6159 5957	5391.90.00		9319 1941	5111.00.00
716 7757	5122.20.00		9319 2361	5117.96.00
798 1909	3590.20.00		9319 2618	3744.96.00
812 2752	5743.20.00		9319 2619	3765.96.00
812 2755	5741.10.00		9319 2809	6426.20.00
812 3394	5746.10.00		9319 4626	4746.20.00
813 1582	5119.00.00		9380 0662	1480.20.00
813 2397	5119.00.00		9380 0662	3228.20.00
813 5492	6414.00.00		9380 2209	1481.20.00
813 7027	6440.00.00		9380 4059	1480.20.00
816 3773	6439.00.00		9380 4059	3228.20.00
816 5309	6405.00.00		9380 4060	1481.20.00
819 0225	5743.10.00		9710 4299	6341.00.00
819 3645	5746.20.00		9840 2544	5124.00.00
819 3649	5805.10.00		9840 2553	6402.00.00
855 8522	5142.00.00		9844 6354	5146.00.00
855 8527	4746.20.00		9844 9025	6417.00.00
855 8533	5746.20.00		9846 7459	5124.00.00
855 8536	5746.10.00		9846 9650	6417.00.00
855 9559	3212.00.00		9847 0968	6383.00.00
856 4248	5147.00.00		9847 2466	6342.00.00
856 4386	3213.00.00		9847 2871	5117.00.00
856 5366	3393.00.00		9847 3328	6420.00.00
856 5366	5122.20.00		9847 5709	6427.00.00
856 7618	5145.00.00		9848 4091	6395.00.00
857 0528	3388.00.00		9848 8010	5103.00.00
857 0528	5148.00.00		9848 8010	5114.00.00
858 2320	3213.00.00		9849 3054	6428.00.00
858 2322	5746.20.00		9944 4744	6344.00.00
858 2330	3393.00.00		9945 5009	6433.00.00
858 2332	5122.20.00			
858 2333	5122.10.00			
858 2350	5145.00.00			
858 7018	5087.00.00			
859 1219	5147.00.00			
859 1222	3212.00.00			
8601 1651	6363.00.00			

# KÄSSBOHRER/FAD



OEM	FAD	OEM	FAD
628 330 05 03	6909.00.00	8.226.225.000 D	6045.00.00
6.284.600.305	4576.00.00	8.226.238.000 C	6048.00.00
628 460 20 05	4595.00.00	8.226.244.000 D	3492.00.00
6.293.500.606	6197.00.00	8.226.247.000 C	6049.00.00
6.851.446.000	5742.10.00	8.226.248.000 C	4911.00.00
6.851.447.000	5742.20.00	8.226.258.000 C	3492.00.00
6.851.459.000	5742.10.00	8.226.259.000 C	3494.00.00
6.851.475.000	5743.20.00	8.226.261.000 C	6043.00.00
6.851.478.000	5742.20.00	8.226.262.000 C	3494.00.00
6.851.479.000	5742.10.00	8.226.280.000 B	4920.00.00
6.851.480.000	5743.20.00	8.226.280.000 C	4920.00.00
6.851.484.000	5743.20.00	8.226.293.000B	6197.00.00
6.851.485.000	5743.10.00	8.226.305.000 C	5686.00.00
6.851.486.000	5742.20.00	8.226.308.000 C	4911.00.00
6.851.487.000	5742.10.00	8.226.313.000 C	5686.00.00
6.851.488.000	5742.20.00	8.226.318.000 B	3497.00.00
6.851.490.000	3581.10.00	8.226.323.000 B	3497.00.00
6.851.491.000	3581.20.00	8.226.355.000	4920.00.00
6.851.517.000	5741.20.00	8.226.380.000 C	4914.00.00
6.851.523.000	5742.20.00	8.226.380.000.0	4914.00.00
6.851.531.000	5743.20.00	82 262 320 660	5170.96.00
6.851.532.000	5742.10.00	82.262.800.000	4920.00.00
8.226.137.000	5686.00.00	82.263.550.000	4920.00.00
8.226.138.000	5687.00.00		
8.226.232.000	3491.00.00		
8.226.236.058	5743.10.00		
8.226.236.059	5743.20.00		
8.226.241.000	3491.00.00		
8.226.257.000	6042.00.00		
8.226.259.000	3494.00.00		
8.226.262.000	3494.00.00		
8.226.306.000	3492.00.00		
8.226.307.000	6049.00.00		
8.226.308.000	4911.00.00		
8.226.328.000	4912.00.00		
8.226.330.000	4915.00.00		
8.226.347.000	6049.00.00		
8.226.356.000	4913.00.00		
8.226.357.000	3491.00.00		
8.226.380.000	4914.00.00		
8.226.381.000	4911.00.00		
8.321.999.319	3590.20.00		
68.515.290.000	4911.20.00		
8.226.147.000 C	5686.00.00		
8.226.148.000 C	5687.00.00		

OEM	FAD
10220897	3903.20.00
5006 070 08	3590.20.00
5211 346 77	6321.00.00
5211 434	6105.00.00
5211 434 08	6105.00.00
5211 435 08	6027.00.00
5211 438	6106.00.00
5211 438 08	6106.00.00
5211 439	6100.00.00
5211 440 08	6101.00.00
5211 441	6102.00.00
5211 441 08	6102.00.00
5211 448	6103.00.00
5211 448 08	6103.00.00
5211 543	4484.96.00
5211 543 08	4484.96.00
5708 158 08	6106.20.00
5708 159 08	6106.10.00
5708 160 08	6027.20.00
5708 161 08	6027.10.00
5708 196 08	6104.20.00
5708 197 08	6104.10.00
5718 665 08	5743.10.00
5718 666 08	5743.20.00
7250 510	7474.20.00
7250 510 08	7474.20.00



OEM	FAD	OEM	FAD	OEM	FAD
36.46710.6000	6699.00.00	81.43220.6099	5956.00.00	81.43230.6018	5910.00.00
36.46710.6003	6698.00.00	81.43220.6100	5956.00.00	81.43230.6030	5546.00.00
36.46710.6005	6698.00.00	81.43220.6102	5538.00.00	81.43230.6030	5921.00.00
81.43220.6010	5910.00.00	81.43220.6106	6173.00.00	81.43230.6030	5937.00.00
81.43220.6012	5910.00.00	81.43220.6108	5959.90.00	81.43230.6030	5941.00.00
81.43220.6013	5910.00.00	81.43220.6129	5546.00.00	81.43230.6030	5959.00.00
81.43220.6015	6692.00.00	81.43220.6129	5921.00.00	81.43230.6031	5940.00.00
81.43220.6020	5910.00.00	81.43220.6129	5937.00.00	81.43230.6037	3698.00.00
81.43220.6025	5948.00.00	81.43220.6129	5941.00.00	81.43230.6037	5537.00.00
81.43220.6028	5910.00.00	81.43220.6129	5959.00.00	81.43230.6038	5922.00.00
81.43220.6035	5910.00.00	81.43220.6129	6181.00.00	81.43230.6039	5922.00.00
81.43220.6040	5910.00.00	81.43220.6140	6186.00.00	81.43230.6043	3698.90.00
81.43220.6041	5910.00.00	81.43220.6148	5538.00.00	81.43230.6049	6173.00.00
81.43220.6042	5951.00.00	81.43220.6151	6194.00.00	81.43230.6051	5323.96.00
81.43220.6043	5952.00.00	81.43220.6152	5538.00.00	81.43230.6061	5117.96.00
81.43220.6047	6692.00.00	81.43220.6161	4108.00.00	81.43230.6068	5323.96.00
81.43220.6052	5910.00.00	81.43220.6168	5339.00.00	81.43230.9031	5940.00.00
81.43220.6053	5531.96.00	81.43220.6174	6191.00.00	81.43250.6007	5554.00.00
81.43220.6055	5170.96.00	81.43220.6183	6194.00.00	81.43250.6011	4137.00.00
81.43220.6056	5910.00.00	81.43220.6186	5538.00.00	81.43250.6014	4130.00.00
81.43220.6067	5950.00.00	81.43220.6189	4107.00.00	81.43250.6016	4137.00.00
81.43220.6068	5950.00.00	81.43220.6190	4108.00.00	81.43270.6030	5943.00.00
81.43220.6070	5938.00.00	81.43220.6196	4112.00.00	81.43270.6034	5943.00.00
81.43220.6071	5938.00.00	81.43220.6203	5594.96.00	81.43270.6040	3765.96.00
81.43220.6072	5938.00.00	81.43220.6229	6693.00.00	81.43270.6045	3765.96.00
81.43220.6073	5170.96.00	81.43220.6236	6188.00.00	81.43270.6047	3500.90.00
81.43220.6090	5950.00.00	81.43220.6247	6201.00.00	81.43270.6056	5944.00.00
81.43220.6091	5938.00.00	81.43220.6258	6683.00.00	81.43270.6057	5943.00.00
81.43220.6092	5950.00.00	81.43220.6264	6683.00.00	81.43270.6064	5323.96.00
81.43220.6093	5938.00.00	81.43220.6267	6188.00.00	81.43270.6065	5524.90.00
81.43220.6096	5546.00.00	81.43220.6272	6188.00.00	81.43270.6067	5944.00.00
81.43220.6096	5921.00.00	81.43220.6275	6683.00.00	81.43270.6074	5943.00.00
81.43220.6096	5937.00.00	81.43220.6276	6194.00.00	81.43270.6075	5944.00.00
81.43220.6096	5941.00.00	81.43220.6278	6683.00.00	81.43270.6076	5943.00.00
81.43220.6096	5959.00.00	81.43220.6279	6683.00.00	81.43270.6077	5944.00.00
81.43220.6097	5546.00.00	81.43220.6304	6693.00.00	81.43270.6078	5943.00.00
81.43220.6097	5921.00.00	81.43220.6305	6693.00.00	81.43270.6079	5944.96.00
81.43220.6097	5937.00.00	81.43220.9092	5950.00.00	81.43270.6081	5944.00.00
81.43220.6097	5941.00.00	81.43220.9140	6186.00.00	81.43270.6082	5943.00.00
81.43220.6097	5959.00.00	81.43230.6014	5546.00.00	81.43270.6096	6189.00.00
81.43220.6098	5546.00.00	81.43230.6014	5921.00.00	81.43270.6105	4492.96.00
81.43220.6098	5921.00.00	81.43230.6014	5937.00.00	81.43270.6117	6219.00.00
81.43220.6098	5937.00.00	81.43230.6014	5941.00.00	81.43270.9034	5943.00.00
81.43220.6098	5941.00.00	81.43230.6014	5959.00.00	81.43270.9056	5944.00.00
81.43220.6098	5959.00.00	81.43230.6015	5940.00.00	81.43270.9078	5943.00.00

OEM	FAD	OEM	FAD	OEM	FAD
81.43315.6012	5535.00.00	81.46610.6593	5932.00.00	81.46611.6045	6689.00.00
81.43718.6006	5522.00.00	81.46610.6594	5946.00.00	81.46611.6064	5219.00.00
81.43718.6007	5522.00.00	81.46610.6596	5235.00.00	81.46611.6065	6691.00.00
81.43718.6009	5522.96.00	81.46610.6597	4165.00.00	81.46611.6067	6198.00.00
81.46610.6088	5520.00.00	81.46610.6606	4097.00.00	81.46611.6068	6202.00.00
81.46610.6089	5539.00.00	81.46610.6608	5946.00.00	81.46611.6096	6196.00.00
81.46610.6129	5335.00.00	81.46610.6609	5932.00.00	81.46611.6108	6688.00.00
81.46610.6147	5946.00.00	81.46610.6614	5235.00.00	81.46611.6131	6687.00.00
81.46610.6159	5219.00.00	81.46610.6615	4165.00.00	81.46611.6133	6223.00.00
81.46610.6195	5946.00.00	81.46610.6621	4164.00.00	81.46611.6138	6684.00.00
81.46610.6196	5932.00.00	81.46610.6630	5946.00.00	81.46611.6139	6684.00.00
81.46610.6200	5219.00.00	81.46610.6631	5932.00.00	81.46611.6150	6681.00.00
81.46610.6201	5946.00.00	81.46610.6634	4165.00.00	81.46611.6151	4153.00.00
81.46610.6202	5932.00.00	81.46610.6635	5235.00.00	81.46611.6157	6321.00.00
81.46610.6257	5946.00.00	81.46610.6639	4164.00.00	81.46611.6158	6321.00.00
81.46610.6281	4152.00.00	81.46610.6643	6221.00.00	81.46611.6159	6321.00.00
81.46610.6300	4152.00.00	81.46610.6648	6681.00.00	81.46611.6197	6216.00.00
81.46610.6303	4152.00.00	81.46610.6656	5259.00.00	81.46611.6198	6216.00.00
81.46610.6304	4152.00.00	81.46610.6659	5259.00.00	81.46611.6199	4131.00.00
81.46610.6327	4152.00.00	81.46610.6660	4167.00.00	81.46611.6200	4131.00.00
81.46610.6329	4152.00.00	81.46610.6689	6203.00.00	81.46611.6201	6684.00.00
81.46610.6360	5536.00.00	81.46610.6708	6198.00.00	81.46611.6202	6684.00.00
81.46610.6361	5536.00.00	81.46610.6716	6202.00.00	81.46611.6217	6252.00.00
81.46610.6374	5975.00.00	81.46610.6720	6203.00.00	81.46710.6037	6179.00.00
81.46610.6376	6206.00.00	81.46610.6721	5536.00.00	81.46710.6054	6179.00.00
81.46610.6409	5932.00.00	81.46610.6722	5536.00.00	81.46710.6059	6179.00.00
81.46610.6414	5532.00.00	81.46610.6723	5536.00.00	81.46710.6080	5933.00.00
81.46610.6415	5946.00.00	81.46610.6725	4115.00.00	81.46710.6081	5934.00.00
81.46610.6424	5235.00.00	81.46610.6735	5235.00.00	81.46710.6112	5216.00.00
81.46610.6425	4165.00.00	81.46610.6740	5932.00.00	81.46710.6117	4104.00.00
81.46610.6432	5235.00.00	81.46610.6743	5235.00.00	81.46710.6122	4134.00.00
81.46610.6434	5235.00.00	81.46610.6753	4116.00.00	81.46710.6131	5564.00.00
81.46610.6436	4165.00.00	81.46610.6754	4116.00.00	81.46710.6136	5933.00.00
81.46610.6437	5235.00.00	81.46610.6756	6211.00.00	81.46710.6137	5934.00.00
81.46610.6476	5946.00.00	81.46610.6761	4169.00.00	81.46710.6145	6179.00.00
81.46610.6503	5946.00.00	81.46610.6767	7685.00.00	81.46710.6163	5216.00.00
81.46610.6504	5932.00.00	81.46610.6768	7685.00.00	81.46710.6165	5216.00.00
81.46610.6513	5235.00.00	81.46610.6779	6212.00.00	81.46710.6167	4134.00.00
81.46610.6515	4165.00.00	81.46610.6780	6212.00.00	81.46710.6172	5933.00.00
81.46610.6531	5932.00.00	81.46610.6782	6212.00.00	81.46710.6173	5934.00.00
81.46610.6532	5946.00.00	81.46610.6790	4136.00.00	81.46710.6175	3777.00.00
81.46610.6537	5235.00.00	81.46610.6791	4136.00.00	81.46710.6176	3776.00.00
81.46610.6538	4165.00.00	81.46610.6798	4145.00.00	81.46710.6194	4134.00.00
81.46610.6548	6691.00.00	81.46610.6803	6325.00.00	81.46710.6195	4134.00.00
81.46610.6565	4164.00.00	81.46610.6876	4145.00.00	81.46710.6198	5216.00.00
81.46610.6567	4164.00.00	81.46611.6004	6224.00.00	81.46710.6236	5210.00.00
81.46610.6569	4164.00.00	81.46611.6005	6224.00.00	81.46710.6237	6697.00.00
81.46610.6578	4145.00.00	81.46611.6006	5259.00.00	81.46710.6238	5245.00.00
81.46610.6579	6694.00.00	81.46611.6014	7685.00.00	81.46710.6239	6697.00.00
81.46610.6584	4166.00.00	81.46611.6019	5975.00.00	81.46710.6240	5245.00.00

OEM	FAD	OEM	FAD	OEM	FAD
81.46710.6241	6697.00.00	81.46710.6420	3777.00.00	81.46711.6723	5210.00.00
81.46710.6242	3777.00.00	81.46710.6421	5933.00.00	81.46711.6724	5564.00.00
81.46710.6251	3777.00.00	81.46710.6422	3776.00.00	81.46711.6725	5216.00.00
81.46710.6253	6322.00.00	81.46710.6434	5333.00.00	81.46711.6726	6215.00.00
81.46710.6254	6322.00.00	81.46710.6435	5333.00.00	81.46711.6728	5332.00.00
81.46710.6255	6322.00.00	81.46710.6436	6213.00.00	81.46711.6729	4119.00.00
81.46710.6265	5564.00.00	81.46710.6438	6214.00.00	81.46711.6734	6322.00.00
81.46710.6266	5564.00.00	81.46710.6439	6214.00.00	81.46711.6736	4134.00.00
81.46710.6267	5210.00.00	81.46710.6443	6207.00.00	81.46711.6740	4094.00.00
81.46710.6268	5210.00.00	81.46710.6444	5934.00.00	81.46711.6759	5934.00.00
81.46710.6281	4104.00.00	81.46710.6451	5933.00.00	81.46711.6760	5934.00.00
81.46710.6282	4104.00.00	81.46710.6453	4123.00.00	81.46711.6761	5934.00.00
81.46710.6294	5934.00.00	81.46710.6456	5333.00.00	81.46711.6765	4123.00.00
81.46710.6295	5933.00.00	81.46710.6457	4123.00.00	81.46711.6766	4123.00.00
81.46710.6302	6179.00.00	81.46710.6458	4123.00.00	81.46711.6767	4123.00.00
81.46710.6314	4162.00.00	81.46710.6459	5976.00.00	81.46711.6770	4096.00.00
81.46710.6315	4162.00.00	81.46710.6459	5977.00.00	81.46711.6771	4147.00.00
81.46710.6316	4162.00.00	81.46710.6816	5564.00.00	81.46711.6772	4096.00.00
81.46710.6319	5219.00.00	81.46710.6818	5976.00.00	81.46711.6773	6218.00.00
81.46710.6337	5933.00.00	81.46710.6830	4134.00.00	81.46711.6782	4096.00.00
81.46710.6340	3776.00.00	81.46710.6836	4134.00.00	81.46711.6783	4096.00.00
81.46710.6344	3776.00.00	81.46710.6851	4119.00.00	81.46711.6786	6792.00.00
81.46710.6345	5933.00.00	81.46710.6852	4119.00.00	81.46711.6802	4148.00.00
81.46710.6353	5216.00.00	81.46710.6862	6792.00.00	81.46711.6803	6690.00.00
81.46710.6354	5216.00.00	81.46710.6863	6792.00.00	81.46711.6804	4148.00.00
81.46710.6355	5210.00.00	81.46710.6864	6792.00.00	81.46711.6808	4148.00.00
81.46710.6356	5210.00.00	81.46710.6865	5332.00.00	81.46711.6820	5216.00.00
81.46710.6359	5564.00.00	81.46710.6866	5332.00.00	81.46711.6823	6791.00.00
81.46710.6360	5564.00.00	81.46710.6875	4123.00.00	81.46711.6833	6322.00.00
81.46710.6361	5216.00.00	81.46710.6876	5933.00.00	81.46711.6858	6218.00.00
81.46710.6362	5564.00.00	81.46710.6877	5934.00.00	81.46711.6860	4135.00.00
81.46710.6370	4104.00.00	81.46710.6879	5934.00.00	81.46711.6861	4135.00.00
81.46710.6371	4104.00.00	81.46710.6881	4123.00.00	81.46711.6874	4096.00.00
81.46710.6372	4104.00.00	81.46710.6904	5564.00.00	81.46711.6875	4096.00.00
81.46710.6373	5210.00.00	81.46710.6908	5976.00.00	81.46711.6876	4096.00.00
81.46710.6375	6322.00.00	81.46710.6909	6792.00.00	81.46711.6877	4147.00.00
81.46710.6376	6322.00.00	81.46710.6910	6792.00.00	81.46711.6878	4147.00.00
81.46710.6377	6322.00.00	81.46710.6912	4134.00.00	81.46711.6879	4147.00.00
81.46710.6378	4134.00.00	81.46710.6918	4094.00.00	81.46711.6891	4148.00.00
81.46710.6379	4134.00.00	81.46710.6928	6322.00.00	81.46711.6892	4148.00.00
81.46710.6380	4134.00.00	81.46710.6966	4133.00.00	81.46711.6893	6690.00.00
81.46710.6388	5215.00.00	81.46710.6974	6792.00.00	81.46711.6894	6690.00.00
81.46710.6393	5215.00.00	81.46710.6994	6215.00.00	81.46711.6895	4148.00.00
81.46710.6396	5564.00.00	81.46711.6711	4132.00.00	81.46711.6896	6690.00.00
81.46710.6397	5564.00.00	81.46711.6712	6792.00.00	81.46711.6921	4135.00.00
81.46710.6409	5245.00.00	81.46711.6714	4133.00.00	81.46711.6933	6323.00.00
81.46710.6410	5245.00.00	81.46711.6715	6791.00.00	81.46711.6934	6323.00.00
81.46710.6418	6222.00.00	81.46711.6719	4119.00.00	81.95301.0015	5743.10.00
81.46710.6419	5934.00.00	81.46711.6720	6694.00.00	81.95301.0016	5743.20.00

OEM	FAD	OEM	FAD	OEM	FAD
81.95301.0022	3581.20.00	81.95301.6178	5743.20.00	85.46610.6104	4116.00.00
81.95301.0022	5810.20.00	81.95301.6179	5743.10.00	85.46610.6105	4141.00.00
81.95301.0025	5742.20.00	81.95301.6184	5856.20.00	85.46610.6107	4143.00.00
81.95301.0038	3590.20.00	81.95301.6194	5743.20.00	85.46610.6108	4138.00.00
81.95301.0040	5336.20.00	81.95301.6219	4109.20.00	85.46610.6112	4146.00.00
81.95301.0041	5337.20.00	81.95301.6219	6425.20.00	85.46610.6118	4149.00.00
81.95301.0045	3590.20.00	81.95301.6222	5746.10.00	85.46610.6121	4117.00.00
81.95301.0074	5741.10.00	81.95301.6224	5743.20.00	85.46610.6140	4117.00.00
81.95301.0077	5805.20.00	81.95301.6225	4109.20.00	85.46610.6141	4141.00.00
81.95301.0078	5805.10.00	81.95301.6225	6425.20.00	85.46610.6142	4146.00.00
81.95301.0079	5746.10.00	81.95301.6226	4109.20.00	85.46610.6143	4143.00.00
81.95301.0083	5743.10.00	81.95301.6226	6425.20.00	85.46610.6144	4138.00.00
81.95301.0084	5743.20.00	81.95301.6232	4163.20.00	85.46610.6152	4149.00.00
81.95301.0097	5743.10.00	81.95301.6234	5743.20.00	85.46610.6160	6680.00.00
81.95301.6016	3590.20.00	81.95301.6237	5743.10.00	85.46610.6162	4156.00.00
81.95301.6030	5743.10.00	81.95301.6249	5746.20.00	85.46610.6163	4157.00.00
81.95301.6043	5743.10.00	81.95301.6261	5742.10.00	85.46610.6201	4115.00.00
81.95301.6048	5743.20.00	81.95301.6267	4109.20.00	85.46610.6208	4138.00.00
81.95301.6049	5743.20.00	81.95301.6267	6425.20.00	85.46610.6212	4146.00.00
81.95301.6050	5743.10.00	81.95301.6274	5743.20.00	85.46610.6218	4149.00.00
81.95301.6053	5743.20.00	81.95301.6278	5743.20.00	85.46610.6244	4158.00.00
81.95301.6054	5743.10.00	81.95301.6279	5743.10.00	85.46610.6246	6680.00.00
81.95301.6060	5746.20.00	81.95301.6286	4126.20.00	85.46610.6247	4159.00.00
81.95301.6068	5741.10.00	81.95301.6291	4109.20.00	90.80415.3107	5741.10.00
81.95301.6070	5742.10.00	81.95301.6291	6425.20.00	90.80415.3113	5741.10.00
81.95301.6087	5743.10.00	81.95301.6297	3581.20.00	90.80415.4117	5742.20.00
81.95301.6090	5743.20.00	81.95301.6304	5805.10.00		
81.95301.6091	5743.10.00	81.95301.6321	5805.20.00		
81.95301.6108	5743.20.00	81.95301.6322	5805.10.00		
81.95301.6112	5743.20.00	81.95302.0039	5535.96.00		
81.95301.6126	5743.20.00	82.46610.6049	4098.00.00		
81.95301.6132	5943.90.00	82.46610.6050	4099.00.00		
81.95301.6133	5945.90.00	82.46610.6079	4168.00.00		
81.95301.6134	5805.20.00	82.46610.6153	4168.00.00		
81.95301.6135	5746.20.00	82.46610.6184	4153.00.00		
81.95301.6139	5746.10.00	82.46610.6185	4153.00.00		
81.95301.6140	5746.20.00	82.46610.6191	4136.00.00		
81.95301.6141	5805.10.00	82.95301.0011	7474.20.00		
81.95301.6142	5805.20.00	83.46610.6001	6252.00.00		
81.95301.6143	5743.20.00	85.43220.6001	6695.00.00		
81.95301.6149	5743.20.00	85.43220.6002	4569.96.00		
81.95301.6154	5743.20.00	85.43220.6004	6696.00.00		
81.95301.6155	5743.10.00	85.43270.6001	4151.00.00		
81.95301.6156	5743.20.00	85.46610.6012	4146.00.00		
81.95301.6163	5741.10.00	85.46610.6018	4149.00.00		
81.95301.6168	5743.10.00	85.46610.6021	4117.00.00		
81.95301.6169	3590.20.00	85.46610.6030	4115.00.00		
81.95301.6172	3590.20.00	85.46610.6056	6324.00.00		
81.95301.6176	3590.20.00	85.46610.6102	4115.00.00		

OEM	FAD	OEM	FAD	OEM	FAD
000 268 01 81	3590.20.00	000 330 94 35	5746.10.00	000 460 21 48	5774.20.00
000 268 48 89	3590.20.00	000 330 95 35	5746.20.00	000 460 24 05	4582.00.00
000 268 52 89	3590.20.00	000 330 96 35	5746.10.00	000 460 25 05	4582.00.00
000 330 00 75	3310.96.00	000 330 98 35	4746.20.00	000 460 26 48	5742.20.00
000 330 01 48	5741.10.00	000 338 08 10	1701.10.00	000 460 27 48	5742.20.00
000 330 02 07	5117.96.00	000 338 16 10	5733.20.00	000 460 28 05	5905.00.00
000 330 02 35	5805.10.00	000 338 18 10	7414.20.00	000 460 28 48	5743.20.00
000 330 02 48	5741.20.00	000 338 20 10	1701.10.00	000 460 29 48	5743.20.00
000 330 03 35	5805.20.00	000 338 34 10	5741.20.00	000 460 34 48	5743.10.00
000 330 05 11	5128.96.00	000 338 42 10	1715.20.00	000 460 35 48	5743.10.00
000 330 06 35	5805.20.00	000 338 43 10	1715.10.00	000 460 36 05	5905.00.00
000 330 07 07	5323.96.00	000 338 44 10	1715.20.00	000 460 39 05	5906.00.00
000 330 07 07	5521.96.00	000 338 45 10	1715.10.00	000 460 41 05	6887.00.00
000 330 07 35	5805.10.00	000 338 50 10	1701.10.00	000 460 41 48	5774.20.00
000 330 08 35	5797.10.00	000 338 50 29	5848.10.00	000 460 43 05	4554.00.00
000 330 09 35	5797.20.00	000 338 51 10	1702.20.00	000 460 43 48	7414.20.00
000 330 11 35	5733.10.00	000 338 53 10	1701.10.00	000 460 45 05	4556.00.00
000 330 12 35	4746.20.00	000 338 54 10	1701.20.00	000 460 45 48	5774.20.00
000 330 13 35	4746.20.00	000 338 60 10	1715.10.00	000 460 48 48	4489.20.00
000 330 14 11	3935.96.00	000 338 61 10	1715.20.00	000 460 49 48	5904.20.00
000 330 14 35	3713.20.00	000 338 62 10	1715.10.00	000 460 50 48	4575.20.00
000 330 14 35	5746.20.00	000 350 01 05	3500.90.00	000 460 51 05	5905.00.00
000 330 15 35	5746.20.00	000 350 01 13	3769.96.00	000 460 55 05	6887.00.00
000 330 19 35	5848.10.00	000 350 02 05	3956.90.00	000 460 56 48	7414.20.00
000 330 20 11	4569.96.00	000 350 02 13	3755.90.00	000 460 57 48	5855.20.00
000 330 22 11	5128.96.00	000 350 03 05	3755.90.00	000 460 58 48	5855.10.00
000 330 26 35	3692.10.00	000 350 04 13	3765.96.00	000 460 60 48	5855.20.00
000 330 27 35	3692.20.00	000 350 05 05	3755.90.00	000 460 61 48	5855.10.00
000 330 29 35	5848.10.00	000 350 05 06	5170.96.00	000 460 68 48	5855.20.00
000 330 31 35	5748.20.00	000 350 06 13	3744.96.00	000 460 69 48	5855.10.00
000 330 32 35	5741.20.00	000 350 10 05	6021.96.00	000 460 70 48	5855.20.00
000 330 33 35	3713.10.00	000 350 10 13	5847.90.00	000 460 71 05	4529.00.00
000 330 33 35	5746.10.00	000 350 11 05	5705.96.00	000 460 71 48	5855.10.00
000 330 40 35	5848.20.00	000 350 14 05	3950.90.00	000 460 72 05	4529.00.00
000 330 41 35	5848.10.00	000 350 20 05	5367.96.00	000 460 72 48	1074.20.00
000 330 49 29	5848.20.00	000 350 21 05	3936.96.00	000 460 75 48	5855.20.00
000 330 50 35	5774.20.00	000 350 22 05	4482.96.00	000 460 77 48	5369.20.00
000 330 56 35	7414.20.00	000 350 23 05	4483.96.00	000 460 78 48	5369.10.00
000 330 68 35	5805.10.00	000 350 24 05	4484.96.00	000 460 83 48	5741.20.00
000 330 69 35	3692.10.00	000 350 25 05	6023.96.00	000 460 84 48	4489.10.00
000 330 70 35	3692.20.00	000 350 28 05	4492.96.00	000 460 85 05	6924.00.00
000 330 72 35	5746.10.00	000 350 28 05	5944.96.00	000 460 85 48	5774.20.00
000 330 77 35	5848.20.00	000 350 29 05	4490.96.00	000 460 92 05	4495.00.00
000 330 78 35	5848.10.00	000 360 098 524	3302.00.00	000 460 93 05	4495.00.00
000 330 81 35	5748.20.00	000 390 098 524	3302.00.00	000 460 95 05	4528.00.00
000 330 85 35	5805.20.00	000 460 01 48	5742.20.00	000 460 98 05	4531.00.00
000 330 86 35	5805.10.00	000 460 03 48	5743.20.00	000 460 99 05	4531.00.00
000 330 87 35	5805.20.00	000 460 06 48	5743.10.00	000 463 23 29	5899.20.00
000 330 88 35	5805.10.00	000 460 12 48	5743.10.00	000 463 24 29	5900.20.00
000 330 93 35	5746.20.00	000 460 17 48	3581.20.00	000 463 25 29	5900.20.00

OEM	FAD	OEM	FAD	OEM	FAD
000 463 26 29	5899.20.00	001 460 15 48	4558.20.00	002 460 63 05	4541.00.00
000 463 32 29	5805.20.00	001 460 16 48	4558.20.00	002 460 64 05	4563.00.00
000 463 34 29	5741.20.00	001 460 17 48	5855.20.00	002 460 83 05	4556.00.00
000 463 40 29	7523.20.00	001 460 20 48	5369.10.00	002 460 88 05	4597.00.00
000 463 41 29	7523.20.00	001 460 21 48	5369.20.00	002 460 89 05	4597.00.00
000 586 01 32	3757.90.00	001 460 22 48	5743.20.00	002 460 96 05	4525.00.00
000 586 06 32	3991.95.00	001 460 24 48	5855.20.00	002 460 97 05	4525.00.00
000 586 07 32	3757.95.00	001 460 29 05	3973.00.00	003 460 29 05	6924.00.00
000 586 09 32	5854.90.00	001 460 30 05	3973.00.00	003 460 32 05	4551.00.00
000 586 10 35	5846.90.00	001 460 42 48	6881.20.00	003 460 39 05	6916.00.00
000 586 11 35	3744.96.00	001 460 44 48	5741.20.00	003 460 42 05	4584.00.00
000 586 12 35	3765.96.00	001 460 49 05	4574.00.00	003 460 46 05	4524.00.00
000 586 14 33	3755.90.00	001 460 50 48	6881.20.00	080 460 67 05	4516.00.00
000 586 15 33	3755.95.00	001 460 62 05	4504.00.00	124 330 08 03	1702.00.00
000 586 19 33	3500.95.00	001 460 63 05	4510.00.00	300 460 02 05	5875.00.00
001 330 01 35	5741.20.00	001 460 67 05	4529.00.00	300 460 03 05	5875.00.00
001 330 02 35	5741.20.00	001 460 69 05	4495.00.00	300 460 04 05	5835.00.00
001 330 03 35	5748.20.00	001 460 70 05	4519.00.00	300 460 05 05	5835.00.00
001 330 04 35	5748.20.00	001 460 71 05	4528.00.00	300 460 06 05	5283.00.00
001 330 07 35	3692.20.00	001 460 73 05	4548.00.00	300 460 07 05	5283.00.00
001 330 08 35	3692.10.00	001 460 74 05	4574.00.00	301 330 00 11	3605.38.00
001 330 09 35	3692.20.00	001 460 76 48	5855.20.00	301 460 00 05	5875.00.00
001 330 10 35	3692.10.00	001 460 79 05	6916.00.00	301 460 01 05	5875.00.00
001 330 10 35	5733.20.00	001 460 85 05	4510.00.00	301 460 05 05	5835.00.00
001 330 12 35	5733.20.00	001 460 85 48	6881.20.00	302 330 00 35	5741.10.00
001 330 14 35	5733.20.00	001 460 86 05	4515.00.00	302 330 01 03	3734.00.00
001 330 18 35	5856.20.00	001 460 87 05	4515.00.00	302 330 01 35	5741.10.00
001 330 21 35	5848.20.00	001 460 89 05	4505.00.00	302 330 02 35	5741.10.00
001 330 22 35	5848.10.00	001 460 90 05	4599.00.00	302 330 03 03	3735.00.00
001 330 26 35	5848.20.00	001 460 91 05	4599.00.00	302 330 03 11	5786.38.00
001 330 27 35	5848.10.00	001 460 96 05	5889.00.00	302 330 03 35	5741.10.00
001 330 48 35	1074.20.00	001 460 98 05	4563.00.00	302 330 04 03	3734.00.00
001 330 88 35	5741.10.00	001 460 99 05	4563.00.00	302 330 06 03	3735.00.00
001 330 99 35	4590.20.00	002 460 04 05	4568.00.00	302 330 07 03	3734.00.00
001 460 03 05	4533.00.00	002 460 05 05	4551.00.00	302 330 09 03	5725.00.00
001 460 04 05	4533.00.00	002 460 10 05	6924.00.00	302 330 09 03	5837.00.00
001 460 05 05	4545.00.00	002 460 12 05	4504.00.00	302 330 11 03	5862.00.00
001 460 05 48	5855.10.00	002 460 13 05	4505.00.00	302 330 13 03	5725.00.00
001 460 06 05	4545.00.00	002 460 43 05	6881.00.00	302 330 13 03	5837.00.00
001 460 06 48	4489.20.00	002 460 44 05	6881.00.00	302 330 14 03	5862.00.00
001 460 07 05	4519.00.00	002 460 45 05	6882.00.00	302 330 15 03	5725.00.00
001 460 07 48	4489.10.00	002 460 46 05	6882.00.00	302 330 15 03	5837.00.00
001 460 08 05	4519.00.00	002 460 47 05	4527.00.00	302 330 16 03	5862.00.00
001 460 11 05	4568.00.00	002 460 48 05	4527.00.00	302 330 17 03	5725.00.00
001 460 11 48	5855.20.00	002 460 49 05	4539.00.00	302 330 17 03	5837.00.00
001 460 13 05	4551.00.00	002 460 50 05	4539.00.00	302 330 18 03	3735.00.00
001 460 13 48	5855.10.00	002 460 51 05	4549.00.00	302 460 05 05	5728.00.00
001 460 14 05	4551.00.00	002 460 52 05	4549.00.00	302 460 06 05	5728.00.00
001 460 14 48	5743.10.00	002 460 61 05	4584.00.00	302 460 06 05	5794.00.00
001 460 15 05	4548.00.00	002 460 62 05	4584.00.00	302 460 14 05	5794.00.00

OEM	FAD	OEM	FAD	OEM	FAD
302 460 16 05	5721.00.00	309 460 25 05	5775.00.00	317 350 07 06	3602.38.00
302 460 18 05	5721.00.00	309 460 26 05	5775.00.00	317 460 57 05	5881.00.00
302 460 20 05	5794.00.00	309 460 29 05	5775.00.00	317 460 58 05	5881.00.00
302 460 24 05	5721.00.00	309 460 30 05	5775.00.00	317 460 61 05	5719.00.00
302 460 33 05	5727.00.00	309 460 31 05	5775.00.00	317 460 63 05	5724.00.00
302 460 34 05	5727.00.00	309 460 32 05	5775.00.00	317 460 65 05	5718.00.00
302 460 37 05	5721.00.00	310 330 00 35	5896.20.00	317 460 66 05	5718.00.00
302 460 38 05	5721.00.00	310 330 01 35	5896.10.00	317 460 67 05	5729.00.00
302 460 39 05	5728.00.00	310 330 02 35	5897.20.00	317 460 69 05	5882.00.00
302 460 40 05	5728.00.00	310 330 03 35	5897.10.00	317 460 70 05	5718.00.00
305 330 04 03	5282.00.00	310 330 04 35	5774.20.00	317 460 71 05	5882.00.00
305 330 06 11	5785.38.00	310 330 06 03	5827.00.00	317 460 72 05	5718.00.00
305 330 08 03	5282.00.00	310 330 06 35	7414.20.00	322 330 10 11	3601.38.00
305 330 10 03	5282.00.00	310 330 07 03	5826.00.00	327 330 01 03	5806.00.00
305 330 11 03	5282.00.00	310 330 08 03	5827.00.00	327 330 03 03	5806.00.00
305 460 03 05	5283.00.00	310 330 08 35	5774.20.00	327 330 04 03	5806.00.00
305 460 04 05	5893.00.00	310 330 09 03	5826.00.00	327 460 00 05	5778.00.00
305 460 06 05	5887.00.00	310 330 10 03	5827.00.00	327 460 06 05	5825.00.00
307 330 01 11	3310.00.00	310 330 10 35	7414.20.00	327 460 16 05	5825.00.00
307 330 01 11	5854.00.00	310 330 11 03	5826.00.00	335 460 05 05	3728.00.00
307 460 00 05	5843.00.00	310 330 12 03	5827.00.00	335 460 07 05	3728.00.00
307 460 04 05	5280.00.00	310 330 12 35	7414.20.00	335 460 08 05	3728.00.00
307 460 05 05	5843.00.00	310 330 13 35	5774.20.00	343 320 16 32	3756.00.00
309 330 06 03	5704.00.00	310 330 16 35	5896.10.00	343 320 16 32	3991.00.00
309 330 07 03	5704.00.00	310 330 17 35	5896.20.00	343 320 16 32	3992.00.00
309 330 08 03	5704.00.00	310 330 18 35	5897.20.00	343 320 17 32	3756.00.00
309 330 11 03	5704.00.00	310 330 19 35	5897.10.00	343 320 17 32	3991.00.00
309 330 12 03	3692.00.00	310 330 20 35	5896.20.00	343 320 17 32	3992.00.00
309 330 13 03	3692.00.00	310 330 21 35	5896.10.00	343 320 18 32	3756.00.00
309 330 14 03	3692.00.00	310 330 22 35	5897.20.00	343 320 18 32	3991.00.00
309 330 16 03	3692.00.00	310 330 23 35	5897.10.00	343 320 18 32	3992.00.00
309 330 17 03	3692.00.00	310 330 24 35	5896.20.00	343 330 01 03	5731.00.00
309 330 18 03	3692.00.00	310 330 25 35	5896.10.00	343 330 01 03	5817.00.00
309 330 19 03	3692.00.00	310 330 26 35	5897.20.00	343 330 03 03	5731.00.00
309 330 20 03	3692.00.00	310 330 27 35	5897.10.00	343 330 03 03	5817.00.00
309 330 21 03	3692.00.00	313 460 01 05	3918.00.00	343 330 04 03	5731.00.00
309 460 03 05	5775.00.00	314 330 03 03	5737.00.00	343 330 04 03	5817.00.00
309 460 04 05	5775.00.00	314 460 03 05	5776.00.00	343 460 04 05	5820.00.00
309 460 05 05	5775.00.00	314 460 08 05	5777.00.00	343 460 08 05	5820.00.00
309 460 08 05	5775.00.00	316 330 02 03	5823.00.00	343 460 10 05	5820.00.00
309 460 09 05	5775.00.00	316 330 06 03	5823.00.00	343 460 12 05	5820.00.00
309 460 10 05	5775.00.00	316 330 07 03	5823.00.00	343 460 14 05	5820.00.00
309 460 11 05	5775.00.00	316 460 06 05	5720.00.00	343 460 15 05	5820.00.00
309 460 12 05	5775.00.00	316 460 07 05	5720.00.00	343 586 00 32	3991.90.00
309 460 13 05	5775.00.00	316 460 08 05	5720.00.00	346 330 29 03	5807.00.00
309 460 14 05	5775.00.00	316 460 09 05	5720.00.00	346 330 39 03	5871.00.00
309 460 20 05	5775.00.00	317 330 02 11	3608.38.00	346 330 43 03	5807.00.00
309 460 22 05	5775.00.00	317 330 04 11	3609.38.00	346 330 44 03	5807.00.00
309 460 23 05	5775.00.00	317 330 05 11	5783.38.00	346 330 45 03	3730.00.00
309 460 24 05	5775.00.00	317 350 06 06	3604.38.00	346 330 49 03	5871.00.00

OEM	FAD	OEM	FAD	OEM	FAD
346 330 5003	3739.00.00	355 460 51 05	3919.00.00	360 460 22 05	5885.00.00
346 330 51 03	3730.00.00	355 460 59 05	3305.00.00	363 460 00 05	3693.00.00
350 330 71 35	5741.10.00	355 460 60 05	3305.00.00	363 460 00 05	5792.00.00
352 330 02 03	5806.00.00	356 330 00 03	6050.00.00	363 460 06 05	5792.00.00
352 330 17 03	5814.00.00	356 330 01 03	6054.00.00	363 460 07 05	5792.00.00
352 330 18 03	5818.00.00	356 330 02 03	6051.00.00	365 460 06 05	3724.00.00
352 330 19 03	5804.00.00	356 350 01 06	5708.00.00	366 460 07 05	3725.00.00
352 330 20 03	5804.00.00	356 463 00 15	6053.00.00	366 460 08 05	3726.00.00
352 330 23 03	5804.00.00	356 463 02 15	6052.00.00	371 330 70 03	5743.00.00
352 330 24 03	5804.00.00	357 330 00 35	5522.96.00	373 460 03 05	5722.00.00
352 330 26 03	5818.00.00	357 330 02 03	3444.00.00	373 460 05 05	5722.00.00
352 330 27 03	5814.00.00	357 330 04 03	3444.00.00	373 460 06 05	5728.00.00
352 330 28 03	5818.00.00	357 330 05 03	3444.00.00	373 460 07 05	5722.00.00
352 350 03 06	5840.00.00	357 330 06 03	5976.00.00	373 460 08 05	5721.00.00
352 350 04 06	3757.00.00	357 330 07 03	5976.00.00	373 460 09 05	5728.00.00
352 460 10 05	3736.00.00	357 330 11 03	6901.00.00	373 460 35 05	5722.00.00
352 460 19 05	3736.00.00	357 330 15 03	6901.00.00	373 460 36 05	5722.00.00
352 460 21 05	5816.00.00	357 330 17 11	3952.00.00	375 460 06 05	6922.00.00
352 460 22 05	5740.00.00	357 330 19 11	6910.00.00	375 460 11 05	6922.00.00
352 460 23 05	3914.00.00	357 330 31 11	3601.38.00	375 460 16 05	4548.00.00
352 460 27 05	3736.00.00	357 330 33 11	6910.00.00	381 330 03 03	5747.00.00
352 460 28 05	3922.00.00	357 330 34 11	3604.38.00	381 330 05 03	5747.00.00
352 460 29 05	5816.00.00	357 330 36 11	3310.00.00	381 330 06 03	5747.00.00
352 460 30 05	5740.00.00	357 330 36 11	5854.00.00	381 330 07 03	5747.00.00
352 460 31 05	3914.00.00	357 330 42 11	3609.38.00	381 350 02 06	5770.00.00
352 460 32 05	3914.00.00	357 333 02 05	5956.00.00	381 350 03 06	3697.00.00
352 460 33 05	5779.00.00	357 333 04 05	6039.00.00	381 350 06 06	5705.00.00
352 460 35 05	3733.00.00	357 333 05 05	6905.00.00	381 350 06 06	5846.00.00
352 460 37 05	3723.00.00	357 333 06 05	4488.00.00	383 330 03 11	3431.00.00
352 460 44 05	3736.00.00	357 333 07 05	6906.00.00	383 350 00 06	5770.00.00
352 460 46 05	5816.00.00	357 333 09 05	4488.00.00	383 350 01 05	3503.00.00
352 460 48 05	3914.00.00	357 460 04 05	5865.00.00	383 460 08 05	5748.00.00
352 460 49 05	3914.00.00	357 460 10 05	5865.00.00	383 460 14 05	5734.00.00
352 460 54 05	3736.00.00	357 460 11 05	5865.00.00	383 460 16 05	5748.00.00
352 460 55 05	5816.00.00	357 460 12 05	5887.00.00	383 460 24 05	5748.00.00
352 460 56 05	3914.00.00	357 460 13 05	5887.00.00	383 460 45 05	5748.00.00
352 460 57 05	3922.00.00	357 460 14 05	3967.00.00	385 330 01 03	5730.00.00
352 460 58 05	5740.00.00	357 460 15 05	3967.00.00	385 330 02 03	3968.00.00
352 460 66 05	3723.00.00	357 460 32 05	6902.00.00	385 330 04 03	5869.00.00
352 460 71 05	3723.00.00	357 460 35 05	4580.00.00	385 330 05 03	5741.00.00
353 330 03 03	5805.00.00	358 330 00 03	5806.00.00	385 330 06 03	5741.00.00
353 330 04 03	5805.00.00	358 330 01 03	5747.00.00	385 330 08 03	3968.00.00
353 330 05 03	5805.00.00	358 330 05 03	5747.00.00	385 330 11 03	5741.00.00
353 330 06 03	5805.00.00	358 330 07 03	5806.00.00	385 330 12 03	5730.00.00
355 460 09 05	3919.00.00	358 330 08 03	5806.00.00	385 330 14 03	5741.00.00
355 460 15 05	3305.00.00	360 460 02 05	5779.00.00	385 330 15 03	5741.00.00
355 460 23 05	4526.00.00	360 460 03 05	5885.00.00	385 330 16 03	3968.00.00
355 460 28 05	4526.00.00	360 460 08 05	5779.00.00	385 330 18 03	3968.00.00
355 460 35 05	3919.00.00	360 460 09 05	5885.00.00	385 330 19 03	5730.00.00
355 460 47 05	4526.00.00	360 460 21 05	5779.00.00	385 330 19 03	5869.00.00



OEM	FAD	OEM	FAD	OEM	FAD
385 330 20 03	5730.00.00	393 330 00 03	5743.00.00	600 330 01 11	3602.38.00
385 330 20 03	5869.00.00	393 330 02 03	5743.00.00	601 330 04 35	5886.20.00
385 350 00 06	5773.00.00	393 330 03 03	5743.00.00	601 330 05 35	5886.10.00
385 350 00 06	5891.00.00	393 330 04 03	5743.00.00	601 460 00 05	5775.00.00
385 350 01 06	3751.00.00	393 350 52 05	3503.00.00	601 460 01 05	5775.00.00
385 350 02 06	3697.00.00	393 350 53 05	3503.00.00	601 460 02 05	5775.00.00
385 460 08 05	5799.00.00	393 350 54 05	3503.00.00	601 460 03 05	5775.00.00
385 460 20 05	5799.00.00	393 350 55 05	3503.00.00	601 460 05 05	5852.00.00
385 460 34 05	5799.00.00	395 320 01 32	3752.00.00	601 460 06 05	5852.00.00
387 460 00 05	3720.00.00	395 320 03 32	3751.00.00	601 460 07 05	5852.00.00
387 460 00 05	5793.00.00	395 320 14 32	3755.00.00	601 460 08 05	5852.00.00
387 460 04 05	5749.00.00	395 320 15 32	5739.00.00	601 460 09 05	5852.00.00
387 460 06 05	5812.00.00	395 350 00 06	3765.00.00	601 460 10 05	5852.00.00
387 460 07 05	5811.00.00	395 350 02 06	3744.00.00	601 460 11 05	5852.00.00
387 460 07 05	5839.00.00	395 350 02 06	5842.00.00	601 460 12 05	5852.00.00
387 460 14 05	5811.00.00	395 350 05 06	3471.00.00	601 460 13 05	5852.00.00
387 460 14 05	5839.00.00	395 350 06 06	5844.00.00	601 460 15 05	5852.00.00
387 460 15 05	5860.00.00	395 350 07 06	3745.00.00	602 330 00 03	5886.00.00
387 460 15 05	5873.00.00	395 350 08 06	3764.00.00	602 330 01 03	5886.00.00
387 460 32 05	5811.00.00	395 350 10 06	3690.00.00	602 330 02 35	5895.20.00
387 460 32 05	5839.00.00	395 350 10 06	5845.00.00	602 330 03 03	5886.00.00
387 460 33 05	5811.00.00	395 350 11 06	3762.00.00	602 330 03 35	5895.20.00
387 460 33 05	5839.00.00	395 350 11 06	3767.00.00	602 330 04 03	5886.00.00
387 460 35 05	5860.00.00	395 350 12 06	3762.00.00	602 330 09 03	3924.00.00
387 460 35 05	5873.00.00	395 350 12 06	3767.00.00	602 330 09 03	5703.00.00
387 460 36 05	5860.00.00	395 350 13 06	3769.00.00	602 330 10 03	3924.00.00
387 460 36 05	5873.00.00	396 460 30 05	3958.00.00	602 330 10 03	5703.00.00
387 460 44 05	5812.00.00	396 460 31 05	3959.00.00	602 330 53 03	3924.00.00
387 460 45 05	5812.00.00	396 460 48 05	3958.00.00	602 330 53 03	5703.00.00
387 460 48 05	5793.00.00	396 460 49 05	3959.00.00	602 330 54 03	3924.00.00
387 460 49 05	5793.00.00	396 460 53 05	4512.00.00	602 330 54 03	5703.00.00
387 460 50 05	5749.00.00	396 460 59 05	4585.00.00	602 330 55 03	5886.00.00
389 320 07 32	5771.00.00	406 460 01 05	4552.00.00	608 330 04 03	1708.00.00
389 320 08 32	5772.00.00	424 330 03 03	4550.00.00	613 330 00 03	6050.00.00
389 330 01 03	3722.00.00	425 460 01 05	4594.00.00	613 330 01 03	6054.00.00
391 330 04 03	3716.00.00	425 460 02 05	4594.00.00	613 463 00 15	6053.00.00
391 330 06 03	5872.00.00	425 460 03 05	4594.00.00	617 330 02 03	3978.00.00
391 330 07 03	3716.00.00	425 460 04 05	4594.00.00	617 330 03 03	3978.00.00
391 330 08 03	5872.00.00	427 460 00 05	4560.00.00	617 460 00 05	5821.00.00
391 330 09 03	3716.00.00	427 460 01 05	4560.00.00	617 460 02 05	5821.00.00
391 330 10 03	5872.00.00	427 460 03 05	4560.00.00	617 460 24 05	3969.00.00
391 330 11 03	3716.00.00	427 460 04 05	4560.00.00	617 460 28 05	5821.00.00
391 330 12 03	5872.00.00	437 460 00 05	4594.00.00	617 460 30 05	4583.00.00
391 460 09 05	3987.00.00	437 460 01 05	4594.00.00	617 460 31 05	4583.00.00
391 460 17 05	3987.00.00	440 460 03 48	3965.20.00	617 460 32 05	5890.00.00
391 460 18 05	3987.00.00	440 460 03 48	7385.20.00	617 460 33 05	5890.00.00
393 320 01 32	3742.00.00	440 460 05 48	3965.20.00	617 460 34 05	3969.00.00
393 320 02 32	3753.00.00	444 333 01 27	6409.96.00	619 460 04 05	3988.00.00
393 320 03 32	3758.00.00	460 330 12 35	1074.20.00	619 460 06 05	3999.00.00
393 320 04 32	3754.00.00	600 330 00 11	3605.38.00	619 460 19 05	3988.00.00

# MERCEDES-BENZ/FAD



OEM	FAD	OEM	FAD	OEM	FAD
619 460 20 05	4546.00.00	624 460 03 48	6107.20.00	631 330 06 03	1706.00.00
619 460 21 05	3999.00.00	625 330 03 03	4458.00.00	631 330 07 03	1704.00.00
619 460 25 05	3708.00.00	625 330 04 03	5874.00.00	631 338 03 10	1703.20.00
619 460 29 05	3708.00.00	625 330 09 03	3937.00.00	631 460 07 05	4536.00.00
619 460 45 05	3988.00.00	625 330 12 03	3937.00.00	632 350 01 06	6914.00.00
619 460 46 05	4546.00.00	625 330 15 03	3974.00.00	634 323 02 16	4586.00.00
619 460 47 05	3999.00.00	625 330 16 03	3974.00.00	634 323 03 16	4587.00.00
619 460 52 05	3708.00.00	625 330 20 03	4458.00.00	634 323 04 16	4586.00.00
620 330 02 11	3433.00.00	625 330 21 03	4458.00.00	634 323 05 16	4587.00.00
620 330 03 03	5836.00.00	625 330 24 03	3974.00.00	634 326 00 16	4588.00.00
620 330 03 11	3435.00.00	625 330 25 03	3974.00.00	634 326 01 16	4589.00.00
620 330 04 03	5836.00.00	625 330 26 03	3977.00.00	634 326 05 16	4588.00.00
620 330 05 03	5864.00.00	625 330 26 03	4458.00.00	634 326 06 16	4589.00.00
620 330 06 03	5864.00.00	625 330 27 03	3977.00.00	634 460 05 05	3492.00.00
620 330 07 03	5836.00.00	625 330 27 03	4458.00.00	647 460 00 05	5811.00.00
620 330 08 03	5836.00.00	625 330 32 03	4567.00.00	647 460 00 05	5839.00.00
620 350 00 06	5851.00.00	625 350 01 06	3699.00.00	647 460 01 05	5811.00.00
620 350 00 06	5858.00.00	625 460 25 05	5907.00.00	647 460 01 05	5839.00.00
620 350 01 06	5851.00.00	625 460 38 05	5906.00.00	647 460 02 05	5860.00.00
620 350 01 06	5858.00.00	625 460 42 05	6887.00.00	647 460 02 05	5873.00.00
620 460 00 05	5749.00.00	625 460 43 05	5905.00.00	647 460 03 05	5860.00.00
620 460 01 05	5822.00.00	625 460 43 05	5906.00.00	647 460 03 05	5873.00.00
620 460 04 05	3971.00.00	625 460 44 05	3923.00.00	652 350 03 06	5705.00.00
620 460 08 05	3971.00.00	625 460 48 05	4554.00.00	652 350 03 06	5846.00.00
620 460 20 05	5749.00.00	625 460 52 05	5906.00.00	653 330 00 11	3432.00.00
620 460 21 05	5822.00.00	625 460 77 05	5905.00.00	653 350 00 06	5773.00.00
620 460 24 05	3938.00.00	625 460 78 05	6887.00.00	653 350 00 06	5891.00.00
620 460 26 05	3938.00.00	625 460 79 05	5906.00.00	653 350 01 05	3503.00.00
620 460 28 05	5749.00.00	625 460 80 05	4556.00.00	653 350 01 06	5705.00.00
620 460 29 05	3971.00.00	628 330 05 03	6909.00.00	653 350 01 06	5846.00.00
620 460 30 05	3971.00.00	628 333 00 03	6885.00.00	653 353 00 05	3503.00.00
620 460 37 05	5749.00.00	628 333 00 05	6885.00.00	654 330 00 11	3431.00.00
620 460 38 05	5822.00.00	628 333 09 05	6913.00.00	654 330 01 11	3431.00.00
620 460 39 05	5822.00.00	628 333 10 05	6885.00.00	654 350 04 06	5706.00.00
620 460 40 05	3938.00.00	628 333 17 05	6913.00.00	654 350 04 06	5849.00.00
620 460 41 05	3938.00.00	628 333 18 05	6885.00.00	654 350 05 06	5706.00.00
622 460 02 05	3976.00.00	628 460 03 05	4576.00.00	654 350 05 06	5849.00.00
622 460 03 05	3976.00.00	628 460 12 05	4576.00.00	654 352 00 05	5706.00.00
622 460 04 05	3975.00.00	628 460 20 05	4595.00.00	654 352 00 05	5849.00.00
622 460 09 05	3976.00.00	629 330 00 03	4581.00.00	655 330 00 11	3434.00.00
622 460 10 05	3976.00.00	629 330 06 03	4581.00.00	655 350 00 06	3742.00.00
622 460 14 05	3975.00.00	629 350 05 06	6197.00.00	655 350 03 05	3503.00.00
622 460 15 05	3975.00.00	629 350 06 06	6197.00.00	655 350 03 06	5851.00.00
624 350 00 06	3765.00.00	629 350 12 06	4566.00.00	655 350 03 06	5858.00.00
624 350 01 06	3759.00.00	629 350 28 06	4566.00.00	658 350 00 05	3503.00.00
624 350 02 06	3690.00.00	631 330 03 03	1703.00.00	658 350 00 06	3742.00.00
624 350 02 06	5845.00.00	631 330 04 03	1705.00.00	658 350 02 06	3742.00.00
624 350 03 06	3761.00.00	631 330 04 10	1703.10.00	659 350 01 06	3744.00.00
624 350 04 06	3768.00.00	631 330 04 35	1704.20.00	659 350 01 06	5842.00.00
624 350 05 06	3769.00.00	631 330 05 03	1704.00.00	659 350 04 06	3745.00.00

OEM	FAD		OEM	FAD		OEM	FAD
659 350 09 06	3762.00.00		671 333 01 05	6904.00.00		941 330 00 11	3302.00.00
659 350 09 06	3767.00.00		671 333 02 05	6905.00.00		941 330 01 03	4450.00.00
659 350 11 06	3765.00.00		671 333 04 05	6906.00.00		941 330 02 03	4450.00.00
659 350 12 06	3759.00.00		671 460 02 05	6900.00.00		941 330 03 03	4450.00.00
659 350 13 06	3690.00.00		671 460 03 05	6902.00.00		942 330 00 03	4496.00.00
659 350 13 06	5845.00.00		673 460 02 05	5888.00.00		942 330 01 03	4496.00.00
659 350 14 06	3761.00.00		673 460 03 05	5831.00.00		942 330 02 03	4496.00.00
659 350 15 06	3768.00.00		673 460 04 05	5888.00.00		942 330 03 03	4457.00.00
659 350 16 06	3769.00.00		673 460 05 05	5831.00.00		942 330 04 03	4457.00.00
659 350 17 06	3760.00.00		673 460 06 05	5888.00.00		942 330 05 03	4458.00.00
659 350 24 06	3744.00.00		673 460 07 05	5831.00.00		942 330 06 03	4458.00.00
659 350 24 06	5842.00.00		673 460 08 05	5888.00.00		942 330 07 03	4496.00.00
659 350 27 06	3745.00.00		673 460 09 05	5831.00.00		942 330 08 03	4459.00.00
659 350 32 06	3762.00.00		675 460 10 05	3306.00.00		942 330 09 03	4458.00.00
659 350 32 06	3767.00.00		675 460 12 05	3972.00.00		942 330 10 03	4580.00.00
659 350 34 06	3765.00.00		675 460 13 05	5631.00.00		942 330 11 03	4496.00.00
659 350 35 06	3759.00.00		675 460 16 05	3306.00.00		942 330 16 03	4457.00.00
659 350 36 06	3690.00.00		675 460 18 05	3972.00.00		942 330 17 03	4580.00.00
659 350 36 06	5845.00.00		675 460 19 05	5631.00.00		942 330 25 03	4580.00.00
659 350 37 06	3761.00.00		675 460 22 05	3306.00.00		942 350 05 05	4538.00.00
659 350 38 06	3768.00.00		675 460 24 05	3972.00.00		942 350 08 05	4538.00.00
659 350 39 06	3769.00.00		675 460 25 05	5631.00.00		942 350 10 05	4480.00.00
662 460 08 05	4572.00.00		675 460 28 05	3306.00.00		944 330 02 03	3937.00.00
662 460 09 05	4571.00.00		675 460 30 05	3972.00.00		944 330 17 03	4567.00.00
666 330 00 11	6919.00.00		675 460 31 05	5631.00.00		944 350 00 05	4480.00.00
667 460 15 05	4534.00.00		676 330 02 03	5829.00.00		944 350 03 05	4481.00.00
667 460 16 05	4573.00.00		676 330 04 03	5829.00.00		944 350 05 05	4481.00.00
667 460 17 05	4534.00.00		676 330 07 03	5829.00.00		944 350 06 05	4481.00.00
667 460 18 05	4573.00.00		676 330 08 03	5863.00.00		945 330 00 03	4553.00.00
668 460 05 05	3916.00.00		676 330 09 03	5829.00.00		945 330 00 07	3301.00.00
668 460 07 05	3916.00.00		676 330 10 03	5863.00.00		945 330 00 11	3304.00.00
668 460 09 05	3916.00.00		676 460 01 05	3307.00.00		945 330 01 03	4553.00.00
668 460 11 05	3916.00.00		676 460 06 05	3307.00.00		945 330 02 03	4451.00.00
668 460 15 05	3917.00.00		676 460 11 05	3307.00.00		945 330 03 03	4451.00.00
668 460 17 05	3917.00.00		676 460 12 05	4564.00.00		945 330 04 03	4553.00.00
668 460 19 05	3917.00.00		676 460 15 05	3307.00.00		945 330 05 03	4451.00.00
668 460 21 05	4535.00.00		676 460 16 05	4564.00.00		945 330 06 03	4553.00.00
668 460 22 05	4535.00.00		677 330 03 03	5866.00.00		945 350 01 05	6407.00.00
669 330 04 03	5828.00.00		677 330 04 03	5866.00.00		947 350 00 05	3979.00.00
669 330 05 03	5828.00.00		699 460 05 05	6927.00.00		947 350 01 05	4480.00.00
670 330 00 03	5828.00.00		699 460 16 48	5536.20.00		947 350 09 05	4481.00.00
670 330 01 03	5828.00.00		699 460 42 05	6925.00.00		947 350 10 05	4480.00.00
670 330 02 03	5828.00.00		699 460 84 05	6926.00.00		948 350 04 05	4481.00.00
670 330 03 03	5828.00.00		699 460 98 05	6926.00.00		948 350 06 05	3979.00.00
670 460 08 05	5365.00.00		730 505	5826.00.00		948 350 12 05	3979.00.00
670 460 12 05	5365.00.00		730 600	5826.00.00		948 350 13 05	3979.00.00
670 460 16 05	5365.00.00		901 460 01 48	1711.20.00		948 350 25 05	6407.00.00
670 460 20 05	5365.00.00		901 460 03 48	1711.20.00		948 350 30 05	4481.00.00
670 460 26 05	5363.00.00		941 330 00 03	4450.00.00		949 330 02 03	4459.00.00
670 460 27 05	5363.00.00		941 330 00 07	3303.00.00		949 330 03 03	4459.00.00

# MERCEDES-BENZ/FAD

OEM	FAD		OEM	FAD		OEM	FAD
949 330 04 03	4559.00.00						
949 330 05 03	4559.00.00						
949 330 08 03	4559.00.00						
949 330 09 03	4459.00.00						
949 330 10 03	4522.00.00						
949 330 11 03	4522.00.00						
949 330 12 03	4511.00.00						
949 330 13 03	4511.00.00						
949 330 14 03	4559.00.00						
949 330 17 03	4522.00.00						
949 330 18 03	4511.00.00						
957 460 05 05	4579.00.00						
957 460 07 05	4579.00.00						
970 330 00 03	4471.00.00						
970 330 01 03	4471.00.00						
970 330 02 03	4471.00.00						
970 330 03 03	4471.00.00						
970 330 04 03	4471.00.00						
970 460 07 05	4514.00.00						
970 460 08 05	4562.00.00						
970 460 09 05	4514.00.00						
970 460 10 05	4562.00.00						
972 460 14 05	4532.00.00						
972 460 15 05	4561.00.00						
972 460 16 05	4532.00.00						
972 460 17 05	4561.00.00						
972 460 18 05	4513.00.00						
972 460 20 05	4513.00.00						
974 460 10 05	4524.00.00						
974 460 11 05	4565.00.00						
974 460 12 05	4524.00.00						
974 460 13 05	4565.00.00						
975 330 02 03	4474.00.00						
975 330 03 03	4474.00.00						
975 330 06 03	6917.00.00						
975 330 07 03	6917.00.00						
975 330 08 03	4474.00.00						
975 330 09 03	6917.00.00						
975 330 17 03	4474.00.00						
SA 508 316 / 01	3302.00.00						
SA 508 316 / 02	3304.00.00						

OEM	FAD
143 929	4440.00.00
144 228	4441.00.00
377 740	5928.00.00
4922-02/1962	4345.00.00
619 687	7720.20.00
654 136	5746.10.00
660 856	3582.00.00
660 857	5743.10.00
660 858	5743.20.00
660 915	3581.00.00
660 916	3581.10.00
660 917	3581.20.00
660 976	3586.00.00
660 977	3584.00.00
665 178	3587.00.00
665 196	3579.00.00
665 197	3573.00.00
678 612	3576.00.00
678 621	5741.10.00
678 622	5741.20.00
683 795	3595.00.00
685 201	3593.00.00
699 432	3597.00.00
700 875	3598.00.00
737 710	3599.00.00
783.24.3143.000	4337.00.00
832.00.3183.000	5198.00.00
832 45	3583.00.00
836.01.3504.000	5914.00.00
837 57	4333.00.00
839.53.3143.000	4333.00.00
863 97	4337.00.00
900 20	3585.00.00
900 81	3588.00.00
917 20	3646.00.00
918 42	4345.00.00
996 56	4387.00.00
997 324	5927.00.00
A4815-20	4334.00.00
A4815-21	4335.00.00
A4815-22	4336.00.00

OEM	FAD	OEM	FAD	OEM	FAD
00 00 566 157	5980.00.00	50 00 288 361	5743.10.00	50 01 850 550	5741.10.00
00 00 691 970	3283.00.00	50 00 295 214	5741.20.00	50 01 852 263	5741.10.00
00 00 745 019	5981.00.00	50 00 295 215	5741.10.00	50 01 858 763	4681.20.00
00 03 401 149	5998.20.00	50 00 450 713	4703.00.00	50 01 860 359	4672.00.00
00 03 401 150	5998.10.00	50 00 450 714	4704.00.00	50 01 860 360	4737.00.00
00 03 401 170	5743.10.00	50 00 516 214	3590.20.00	50 01 868 367	4710.00.00
00 03 401 206	5856.10.00	50 00 559 336	5746.10.00	50 01 868 383	4693.00.00
00 03 401 207	5856.20.00	50 00 590 236	5743.20.00	50 01 868 404	4733.00.00
00 03 406 169	5743.20.00	50 00 613 837	4679.00.00	50 10 005 937	3285.00.00
00 03 406 212	5741.20.00	50 00 725 267	3296.00.00	50 10 025 292	3284.00.00
00 03 406 213	5741.10.00	50 00 748 868	3293.00.00	50 10 037 602	3948.00.00
00 03 406 218	5741.10.00	50 00 748 868	3298.00.00	50 10 037 603	3948.00.00
00 03 406 236	5743.20.00	50 00 750 976	5985.00.00	50 10 060 764	3297.00.00
00 03 406 251	5743.20.00	50 00 761 671	4731.00.00	50 10 064 641	5985.00.00
00 03 406 252	5805.20.00	50 00 783 574	5985.00.00	50 10 064 715	4725.00.00
00 03 406 253	5741.20.00	50 00 785 429	3292.00.00	50 10 094 838	5985.00.00
00 03 406 254	5743.20.00	50 00 786 532	4660.00.00	50 10 094 839	4690.00.00
00 03 406 260	5743.20.00	50 00 788 392	5983.00.00	50 10 094 840	3282.00.00
00 03 406 261	5743.20.00	50 00 791 032	4673.00.00	50 10 094 941	5985.00.00
00 23 123 159	5987.00.00	50 00 792 132	7474.20.00	50 10 097 562	6359.00.00
00 23 123 220	3289.00.00	50 00 802 123	5755.96.00	50 10 098 467	4675.00.00
00 23 123 225	5760.00.00	50 00 803 461	5998.20.00	50 10 104 465	5992.96.00
00 23 123 233	5996.00.00	50 00 803 462	5998.10.00	50 10 130 344	3291.00.00
00 23 123 237	5755.00.00	50 00 804 824	5743.20.00	50 10 130 382	4725.00.00
00 23 123 238	5757.00.00	50 00 807 553	5805.10.00	50 10 130 453	3293.00.00
00 23 123 240	5760.00.00	50 00 807 554	5805.20.00	50 10 130 453	3298.00.00
00 23 123 247	3293.00.00	50 00 808 458	5742.20.00	50 10 130 456	3948.00.00
00 23 123 247	3298.00.00	50 00 810 038	5910.00.00	50 10 144 543	3590.20.00
00 23 123 252	5983.00.00	50 00 812 483	5741.20.00	50 10 144 549	3296.00.00
00 23 123 253	5982.00.00	50 00 814 096	5805.10.00	50 10 144 552	3296.00.00
00 23 123 253	5985.00.00	50 00 814 097	5805.20.00	50 10 145 077	4666.00.00
00 23 123 262	4661.00.00	50 00 814 841	3284.96.00	50 10 145 077	5752.00.00
00 23 123 265	5759.00.00	50 00 819 365	5992.96.00	50 10 145 078	4674.00.00
00 23 123 275	5993.00.00	50 00 823 947	5746.10.00	50 10 145 584	4675.00.00
00 23 162 046	3590.20.00	50 00 823 997	5746.10.00	50 10 151 528	4731.00.00
1 151 394	3289.00.00	50 00 874 577	3293.00.00	50 10 197 399	3286.00.00
1 151 395	5755.00.00	50 00 874 577	3298.00.00	50 10 207 168	3287.00.00
1 151 396	5757.00.00	50 01 014 520	5524.90.00	50 10 207 724	4731.00.00
20 847 191	4711.00.00	50 01 823 718	4163.20.00	50 10 207 725	4702.00.00
23 123 224	4666.00.00	50 01 826 368	5760.00.00	50 10 207 726	3944.00.00
23 123 225	5760.00.00	50 01 831 481	5856.20.00	50 10 207 727	3945.00.00
23 123 237	5755.00.00	50 01 832 579	5856.10.00	50 10 207 728	4700.00.00
23 123 238	5757.00.00	50 01 832 580	5856.20.00	50 10 207 729	4701.00.00
23 123 240	5760.00.00	50 01 832 581	5743.10.00	50 10 207 771	3288.00.00
23 123 256	5995.00.00	50 01 840 095	3637.96.00	50 10 216 608	4677.00.00
25 379 292	4693.00.00	50 01 842 823	5170.96.00	50 10 224 899	4735.00.00
50 00 027 957	5910.00.00	50 01 844 135	5805.10.00	50 10 229 243	4698.00.00
50 00 145 581	4673.00.00	50 01 844 136	5805.20.00	50 10 259 241	4724.00.00
50 00 242 159	5741.20.00	50 01 850 530	5985.00.00	50 10 268 035	5994.00.00
50 00 288 360	5743.20.00	50 01 850 549	5741.20.00	50 10 294 287	4670.00.00

OEM	FAD	OEM	FAD	OEM	FAD
50 10 294 288	4668.00.00	50 10 587 050	4710.00.00		
50 10 294 289	4669.00.00	50 10 587 052	4733.00.00		
50 10 294 320	4730.00.00	50 10 587 053	4710.00.00		
50 10 308 082	4676.00.00	50 10 600 483	4686.00.00		
50 10 308 083	4736.00.00	50 10 600 822	4683.00.00		
50 10 308 214	4680.00.00	50 10 630 254	4695.00.00		
50 10 308 215	4673.00.00	50 10 630 812	4687.00.00		
50 10 383 203	4718.00.00	50 10 630 813	4687.00.00		
50 10 393 015	4732.00.00	50 10 630 820	4693.00.00		
50 10 395 796	4678.00.00	50 10 630 821	4693.00.00		
50 10 395 797	4715.00.00	50 10 630 822	4684.00.00		
50 10 439 021	4682.00.00	50 10 630 823	4684.00.00		
50 10 439 022	4681.00.00	50 10 791 275	4673.00.00		
50 10 439 023	4699.00.00	720 128	4667.00.00		
50 10 439 078	4709.00.00	7420 630 813	4688.00.00		
50 10 439 631	4675.00.00	7420 847 190	4711.00.00		
50 10 439 984	4680.00.00	74 21 560 965	4733.00.00		
50 10 488 051	4713.00.00	74 85 114 932	4725.00.00		
50 10 488 052	4720.00.00	77 01 002 911	5742.20.00		
50 10 488 053	4698.00.00	77 01 011 267	3698.90.00		
50 10 488 084	4712.00.00	77 01 011 412	5743.20.00		
50 10 488 096	4697.00.00	77 01 016 946	5741.20.00		
50 10 488 146	4719.00.00				
50 10 488 164	4708.00.00				
50 10 488 165	4722.00.00				
50 10 488 166	4721.00.00				
50 10 488 336	4696.00.00				
50 10 488 639	4712.00.00				
50 10 488 759	4712.00.00				
50 10 488 836	4718.00.00				
50 10 499 243	4716.00.00				
50 10 517 082	4716.00.00				
50 10 557 233	4696.00.00				
50 10 557 234	4724.00.00				
50 10 557 243	3297.00.00				
50 10 557 341	4712.00.00				
50 10 557 423	4707.00.00				
50 10 557 523	4694.00.00				
50 10 557 524	4724.00.00				
50 10 566 049	4678.00.00				
50 10 566 050	4715.00.00				
50 10 566 058	7762.00.00				
50 10 566 059	4676.00.00				
50 10 566 062	4699.00.00				
50 10 566 063	4682.00.00				
50 10 566 157	4714.00.00				
50 10 587 004	4683.00.00				
50 10 587 034	4685.00.00				
50 10 587 038	4685.00.00				
50 10 587 049	4733.00.00				



OEM	FAD		OEM	FAD		OEM	FAD
1 104 334	5323.96.00		1 499 475	6862.00.00		409 639	3368.00.00
1 104 335	5170.96.00		1 499 476	6860.00.00		414 531	3138.00.00
1 104 336	5587.96.00		1 499 477	6863.00.00		415 400	4771.00.00
114 406	5048.96.00		1 499 478	6864.00.00		416 159	6868.00.00
1 304 569	3087.00.00		1 499 479	6865.00.00		417 290	3369.00.00
1 324 890	6842.00.00		1 500 572	4789.00.00		417 676	4778.00.00
1 326 775	3084.00.00		1 501 030	6833.00.00		421 573	6837.00.00
1 334 139	6830.00.00		1 527 978	4793.00.00		434 493	4795.00.00
1 337 366	5810.10.00		1 534 756	4126.20.00		445 599	3361.00.00
1 337 367	3581.20.00		1 722 746	6861.00.00		445 626	6851.00.00
1 337 367	5810.20.00		1 722 747	6862.00.00		445 629	6853.00.00
1 338 769	3083.00.00		1 722 748	6860.00.00		465 816	3362.00.00
1 343 266	6835.00.00		1 722 749	6863.00.00		466 801	3362.00.00
1 343 278	4776.00.00		1 722 750	6864.00.00		475 463	6834.00.00
1 343 283	6838.00.00		1 722 751	6865.00.00		477 889	4785.00.00
1 357 674	6832.20.00		1 723 895	6833.00.00		477 890	4779.00.00
1 357 674	6852.20.00		1 723 896	4793.00.00		481 217	4770.00.00
1 358 792	5743.10.00		1 734 019	6832.00.00		481 959	4782.00.00
1 358 793	5743.20.00		1 734 020	3126.00.00		483 527	6844.00.00
1 361 413	6832.00.00		1 737 684	4793.00.00		486 590	4787.00.00
1 367 282	4790.00.00		1 737 683	6833.00.00		488 056	4788.00.00
1 369 917	4773.00.00		1 738 380	5743.10.00		488 738	4783.00.00
1 376 902	7523.20.00		1 738 381	5743.20.00		488 739	4784.00.00
1 379 423	3343.00.00		1 759 690	6835.00.00		489 987	3362.00.00
1 383 405	3089.20.00		1 759 691	6838.00.00		489 989	3361.00.00
1 384 025	3082.00.00		1 766 015	6851.00.00		550 806	5323.96.00
1 384 027	6847.00.00		1 767 328	5743.20.00		550 808	6409.96.00
1 385 251	6833.00.00		1 768 898	3082.00.00		621 863	3363.00.00
1 393 298	6841.00.00		1 769 597	6847.00.00		638 860	3363.96.00
1 394 443	7981.20.00		1 770 732	4779.00.00		638 861	5847.96.00
1 394 444	7982.20.00		1 897 333	6832.00.00		638 862	5170.96.00
1 394 884	6849.00.00		1 897 335	6833.00.00		639 287	5170.96.00
1 395 614	6832.00.00		1 897 336	4793.00.00		639 370	5323.96.00
1 397 866	3126.00.00		1 897 669	4770.00.00		649 346	3364.00.00
1 399 180	6831.00.00		1 897 671	4777.00.00		651 156	3365.00.00
1 399 182	4791.00.00		1 897 673	6834.00.00		651 157	3366.00.00
1 409 918	6833.00.00		278 665	3148.00.00		651 158	3367.00.00
1 420 698	6843.00.00		283 783	5743.10.00			
1 428 347	3083.00.00		283 784	5743.20.00			
1 438 475	4792.00.00		291 396	6840.00.00			
1 431 471	4785.00.00		306 981	3149.00.00			
1 431 472	4779.00.00		345 124	3348.00.00			
1 431 475	4782.00.00		352 645	5810.10.00			
1 485 758	4780.00.00		352 646	5810.20.00			
1 485 760	6864.00.00		388 943	6836.00.00			
1 486 757	4780.00.00		390 784	3081.00.00			
1 486 758	4781.00.00		395 009	5743.10.00			
1 488 890	4126.20.00		395 010	5743.20.00			
1 499 474	6861.00.00		395 350	3126.00.00			



OEM	FAD	OEM	FAD	OEM	FAD
1 071 170	4250.00.00	1 587 489	4251.00.00	20 367 004	6720.00.00
1 071 344	6264.00.00	1 588 263	6734.00.00	20 367 555	4262.00.00
1 075 005	6725.00.00	1 589 817	5584.00.00	20 374 444	6284.00.00
1 075 006	4243.00.00	1 591 689	5580.90.00	20 374 698	4241.20.00
1 075 255	5580.90.00	1 592 939	3075.00.00	20 374 831	6267.00.00
1 075 260	4256.00.00	1 592 940	4223.00.00	20 375 555	6276.00.00
1 075 663	5141.00.00	1 598 588	5581.90.00	20 375 787	4236.00.00
1 075 664	4224.00.00	1 599 175	4245.00.00	20 382 314	6721.00.00
1 080 690	5587.00.00	1 605 035	6758.00.00	20 383 080	4265.00.00
1 080 792	6732.00.00	1 606 200	5587.00.00	20 383 081	4266.00.00
1 082 104	6758.00.00	1 606 277	6734.00.00	20 390 745	6726.00.00
1 083 744	6729.00.00	1 606 282	4251.00.00	20 393 061	6747.00.00
1 088 985	6768.00.00	1 606 283	3074.00.00	20 393 063	4224.00.00
1 094 219	4216.00.00	1 606 284	7720.00.00	20 393 069	5141.00.00
1 094 334	4219.00.00	1 606 551	5598.00.00	20 393 071	4220.00.00
1 130 567	6733.00.00	1 607 079	5594.00.00	20 393 079	4248.00.00
1 130 568	6765.00.00	1 608 351	6750.20.00	20 393 083	6768.00.00
1 134 840	4247.00.00	1 608 352	6750.10.00	20 393 091	6278.00.00
1 134 955	5388.90.00	1 610 338	5595.00.00	20 393 097	6746.00.00
1 135 030	5597.90.00	1 611 880	4212.00.00	20 393 186	6276.00.00
1 135 427	5597.00.00	1 612 254	6746.00.00	20 393 187	6268.00.00
1 135 427	5599.00.00	1 612 781	6733.00.00	20 400 909	4229.00.00
1 135 428	6751.00.00	1 613 351	4245.00.00	20 400 940	4250.00.00
1 135 429	6756.00.00	1 614 838	6733.00.00	20 400 942	4244.00.00
1 135 630	4242.00.00	1 626 493	6734.00.00	20 400 944	6264.00.00
1 136 891	6751.90.00	1 626 494	5136.00.00	20 410 053	4259.00.00
1 190 778	5805.20.00	1 626 637	6769.00.00	20 410 530	6284.00.00
1 194 390	6753.00.00	1 626 670	4212.00.00	20 442 113	6278.00.00
1 197 338	5493.00.00	1 626 671	4245.00.00	20 443 061	6266.00.00
1 197 339	4252.00.00	1 626 751	5595.00.00	20 443 062	6275.00.00
1 505 758	3546.10.00	1 626 957	4258.00.00	20 443 063	6262.00.00
1 505 759	3546.20.00	1 628 107	5586.90.00	20 443 065	6266.00.00
1 507 822	3546.10.00	1 628 483	6738.00.00	20 443 066	6275.00.00
1 507 823	3546.20.00	1 628 635	4248.00.00	20 443 067	6262.00.00
1 507 826	7720.20.00	1 628 636	5596.00.00	20 453 123	4264.00.00
1 517 439	5746.10.00	1 629 072	4256.00.00	20 477 805	4225.00.00
1 517 440	5746.20.00	1 629 668	4225.00.00	20 477 807	4263.00.00
1 517 444	5746.20.00	1 695 585	7720.20.00	20 490 123	5494.00.00
1 517 448	5805.10.00	1 695 776	7720.20.00	20 497 798	6261.00.00
1 517 449	5805.20.00	1 695 840	7720.10.00	20 497 799	6263.00.00
1 518 142	5805.20.00	1 696 920	4746.20.00	20 497 800	6731.00.00
1 524 382	4267.00.00	1 697 246	4208.20.00	20 502 944	6721.00.00
1 527 234	6762.20.00	1 698 047	4208.20.00	20 507 262	6720.00.00
1 573 572	6750.00.00	1 698 190	5746.10.00	20 509 018	6284.00.00
1 575 690	4219.00.00	1 698 191	5746.20.00	20 513 951	6278.00.00
1 576 092	3071.00.00	1 698 532	3546.20.00	20 554 908	5580.90.00
1 576 092	3074.00.00	1 698 533	3546.10.00	20 556 490	5586.00.00
1 576 093	7720.00.00	1 698 557	7720.20.00	20 556 490	6723.00.00
1 576 816	4251.00.00	1 698 846	3546.20.00	20 556 491	6761.00.00
1 581 527	5594.00.00	1 698 847	3546.10.00	20 556 492	6737.00.00

OEM	FAD	OEM	FAD	OEM	FAD
20 556 586	6738.00.00	3 097 228	4222.20.00	6 790 572	6739.00.00
20 581 086	4234.00.00	3 097 999	5494.20.00	6 790 607	4244.00.00
20 581 089	4234.20.00	3 098 294	6748.00.00	6 790 766	4244.00.00
20 710 008	4234.10.00	3 098 295	6263.10.00	6 799 189	4260.00.00
20 727 840	4693.00.00	3 099 129	4163.20.00	6 799 190	4208.00.00
20 739 082	6260.00.00	3 099 529	4222.20.00	6 853 511	6767.00.00
20 741 695	6720.00.00	3 110 001	5596.10.00	6 853 913	3590.20.00
20 741 703	6720.00.00	3 112 050	6261.00.00	6 862 225	6732.00.00
20 742 117	4267.00.00	3 112 122	6731.00.00	70 311 662	6274.00.00
20 745 923	5494.00.00	3 112 273	6263.00.00	70 311 664	6260.00.00
20 818 854	4712.00.00	3 112 282	6281.00.00	70 311 665	6273.00.00
20 994 418	6266.00.00	3 116 050	4209.00.00	70 371 272	6283.00.00
20 994 419	6275.00.00	3 124 480	4229.00.00	70 397 005	6265.00.00
20 994 420	6262.00.00	3 124 594	4229.00.00	70 397 006	6282.00.00
21 106 157	4259.00.00	3 124 964	4208.00.00	74 20 741 703	6720.00.00
21 106 930	6276.00.00	3 127 737	6264.00.00	74 21 560 965	4733.00.00
21 106 933	4236.00.00	3 133 173	5524.90.00	8 132 373	4210.00.00
21 106 936	6726.00.00	3 172 829	6744.00.00	8 154 016	5598.00.00
21 252 481	4265.00.00	3 173 291	5586.00.00	8 154 017	5594.00.00
21 252 480	6267.00.00	3 173 291	6723.00.00	8 154 444	6730.00.00
21 260 274	6727.00.00	3 173 292	6761.00.00	8 156 123	6754.00.00
21 260 275	6728.00.00	3 173 293	6737.00.00	8 158 206	5594.00.00
21 260 283	4266.00.00	3 173 294	6738.00.00	8 158 207	5594.00.00
21 260 286	6746.00.00	3 173 613	4218.00.00	8 190 034	4257.00.00
21 308 022	5494.00.00	3 173 614	4232.00.00	8 190 146	4220.00.00
21 406 952	6268.00.00	3 173 759	5580.90.00	8 365 399	6756.00.00
21 426 652	6274.00.00	3 198 234	6728.00.00	85 104 188	5494.20.00
21 461 309	6283.00.00	3 198 276	6727.00.00	85 104 265	6748.00.00
21 525 324	6274.00.00	3 198 309	4490.96.00	85 104 266	6263.10.00
21 560 965	4733.00.00	382 745	6762.20.00	85 114 144	3075.00.00
24 425 411	6272.00.00	3 944 046	4263.00.00	85 114 145	4223.00.00
24 425 660	6278.00.00	3 962 343	6769.00.00	85 114 190	4243.00.00
25 370 844	4733.00.00	3 962 843	4200.00.00	85 114 197	6733.00.00
25 370 845	4710.00.00	3 985 570	6746.00.00	85 114 200	5596.00.00
271 187	5323.96.00	3 986 433	4225.00.00	85 115 635	6274.00.00
271 188	5121.90.00	3 986 452	6276.00.00	9 519 278	5494.00.00
273 373	5594.96.00	3 987 354	4218.00.00	9 523 163	6282.00.00
273 375	5945.90.00	3 988 697	6747.00.00	9 523 794	6759.00.00
273 612	5386.96.00	3 988 701	4224.00.00	9 523 795	6755.00.00
273 706	5943.90.00	3 988 704	5141.00.00	9 959 151	6261.00.00
274 019	5594.96.00	3 988 708	4248.00.00	9 959 152	6263.00.00
274 056	5587.96.00	3 988 710	4248.00.00	9 959 153	6731.00.00
274 068	3744.96.00	3 988 711	6769.00.00	9 959 462	6265.00.00
274 069	5589.90.00	3 988 965	5596.20.00	9 959 503	4237.00.00
276 192	5587.96.00	3 988 968	5596.10.00		
3 039 647	4211.00.00	4 941 233	5594.96.00		
3 090 727	5596.20.00	6 027 074	3590.20.00		
3 090 728	5596.10.00	6 771 112	5140.00.00		
3 092 472	5596.20.00	6 777 705	4240.00.00		
3 093 647	4233.20.00	6 777 855	4229.00.00		

**Pregled uporednih oznaka  
FAD / OEM**

**Cross references  
FAD / OEM**

FAD	OEM	FAD	OEM	FAD	OEM
3142.20.00	0 273 203	5394.00.00	0 171 215	6771.96.00	1 376 729
3142.20.00	1 399 724	5398.00.00	0 267 743	6772.00.00	0 658 104
3142.20.00	1 399 724	5398.00.00	1 361 650	6773.00.00	1 257 992
3744.96.00	0 691 703	5398.00.00	1 656 428	6773.00.00	1 351 732
3755.90.00	0 693 778	5398.00.00	1 656 428	6773.00.00	1 385 490
3873.00.00	0 080 521	5399.00.00	0 646 373	6777.00.00	1 270 853
3873.00.00	080 521	5399.00.00	0 655 695	6777.00.00	1 353 391
3873.96.00	0 698 724	5399.00.00	0 655 697	6780.00.00	1 290 321
3873.96.00	698 724	5399.00.00	1 284 860	6780.00.00	1 353 394
3875.90.00	0 696 600	5399.00.00	1 620 438	6781.00.00	1 143 324
3875.90.00	696 600	5587.96.00	696 321	6781.00.00	1 191 900
3876.00.00	0 649 819	5594.96.00	0 513 757	6782.00.00	1 257 991
3876.00.00	1 620 437	5594.96.00	0 691 709	6782.00.00	1 351 718
3876.00.00	1 793 877	5741.10.00	0 607 998	6782.00.00	1 385 493
3877.00.00	1 361 652	5741.20.00	0 586 753	6783.00.00	1 315 530
3877.00.00	1 620 436	5741.20.00	0 607 999	6783.00.00	1 351 731
3877.00.00	1 620 436	5741.20.00	0 694 298	6783.00.00	1 385 506
3877.00.00	1 793 876	5741.20.00	0 694 360	6784.00.00	1 283 211
3879.00.00	1 291 060	5741.20.00	0 698 609	6784.00.00	1 351 714
3879.00.00	1 351 734	5741.20.00	1 229 944	6784.00.00	1 385 497
3879.00.00	1 385 499	5741.20.00	1 331 925	6786.00.00	1 297 572
3889.00.00	0 094 044	5742.20.00	0 069 867	6786.00.00	1 361 155
3889.00.00	0 274 878	5742.20.00	0 161 376	6787.00.00	1 363 858
3889.00.00	1 152 427	5742.20.00	0 608 000	6787.00.00	1 448 062
3903.20.00	1 320 855	5742.20.00	1 142 173	6789.20.00	1 603 788
3903.20.00	1 342 026	5743.10.00	0 607 053	6789.20.00	1 604 105
3965.20.00	0 516 089	5743.10.00	0 696 225	6790.10.00	ACU 9239
4163.20.00	1 271 125	5743.10.00	1 228 115	6790.20.00	ACU 9240
4233.20.00	3 093 647	5743.20.00	0 607 981	6793.00.00	1 291 048
4471.00.00	1 400 156	5743.20.00	0 698 450	6793.00.00	1 351 735
4471.00.00	1 405 823	5743.20.00	1 257 890	6793.00.00	1 385 500
4471.00.00	1 407 963	5743.20.00	1 603 789	6794.00.00	1 306 333
5117.96.00	0 067 354	5746.10.00	0 607 452	6794.00.00	1 351 741
5121.90.00	0 691 704	5746.20.00	0 110 197	6794.00.00	1 385 487
5128.96.00	1 321 936	5746.20.00	0 607 451	6795.00.00	0 589 943
5170.96.00	0 689 749	5746.20.00	0 607 453	6795.20.00	1 344 684
5323.96.00	0 689 748	5746.20.00	1 228 114	6796.00.00	1 395 994
5385.00.00	0 099 990	5805.20.00	0 608 530	6798.00.00	1 700 000
5385.00.00	099 900	5810.20.00	0 586 714	6811.10.00	1 604 247
5386.00.00	0 661 406	5810.20.00	0 607 073	6811.20.00	1 604 248
5386.00.00	0 661 407	5810.20.00	0 609 634	6812.00.00	1 405 655
5387.00.00	1 261 101	5810.20.00	0 609 643	6812.00.00	1 406 025
5389.00.00	1 283 212	5810.20.00	0 696 226	6812.00.00	1 407 144
5389.00.00	1 351 715	5847.96.00	0 689 747	6812.00.00	1 700 912
5389.00.00	1 385 492	5959.90.00	1 271 124	6814.00.00	1 363 859
5392.00.00	0 094 038	6409.96.00	1 243 618	6814.00.00	1 448 063
5392.00.00	0 525 433	6770.00.00	0 080 521	6814.00.00	1 602 821
5393.00.00	0 094 029	6770.00.00	1 368 270	6815.00.00	1 351 737
5393.00.00	0 117 343	6770.00.00	1 390 932	6815.00.00	1 385 498
5393.00.00	94 029	6770.00.00	1 617 096	6815.00.00	1 311 048
5394.00.00	0 094 016	6770.90.00	1 398 368	6816.00.00	1 294 251

FAD	OEM		FAD	OEM		FAD	OEM
6817.00.00	1 270 854						
6817.00.00	1 337 644						
6820.00.00	1 602 820						
6821.00.00	1 380 417						
6821.00.00	1 451 129						
6823.00.00	1 406 038						
6823.00.00	1 700 914						
6824.00.00	1 700 001						
6825.00.00	1 351 205						
6825.00.00	1 353 395						
6826.00.00	1 405 363						
6827.00.00	1 408 040						
6828.00.00	1 451 122						
6829.00.00	1 426 101						
6980.00.00	1 732 972						
6981.00.00	1 405 309						
6982.00.00	1 451 118						
6983.00.00	1 451 119						
6985.00.00	1 426 375						
6985.00.00	1 451 126						
6986.00.00	1 395 993						
6987.00.00	1 321 170						
6987.00.00	1 351 743						
6987.00.00	1 385 494						
7474.20.00	0 817 824						
7474.20.00	817 824						

FAD	OEM	FAD	OEM	FAD	OEM
1480.20.00	9380 0662	5106.00.00	4101 1006	5144.00.00	4204 3912
1480.20.00	9380 4059	5106.00.00	4206 5332	5145.00.00	856 7618
1481.20.00	9380 2209	5107.00.00	4205 5474	5145.00.00	858 2350
1481.20.00	9380 4060	5108.00.00	4201 9062	5146.00.00	9844 6354
3203.20.00	466 3787	5111.00.00	445 7748	5147.00.00	856 4248
3212.00.00	855 9559	5111.00.00	9319 1941	5147.00.00	859 1219
3212.00.00	859 1222	5113.00.00	4208 7842	5148.00.00	857 0528
3213.00.00	856 4386	5113.00.00	474 7960	5149.00.00	4 121 5165
3213.00.00	858 2320	5113.00.00	474 7961	5170.96.00	4248 8722
3228.20.00	9380 0662	5114.00.00	4212 5057	5391.10.00	4 018 037
3228.20.00	9380 4059	5114.00.00	471 4134	5391.10.00	4 663 791
3388.00.00	857 0528	5114.00.00	9848 8010	5391.20.00	4 018 036
3393.00.00	856 5366	5116.00.00	471 9609	5391.20.00	4 663 787
3393.00.00	858 2330	5117.00.00	9847 2871	5391.90.00	6159 5957
3537.00.00	4220 0700	5117.96.00	9319 2361	5741.10.00	298 0129
3537.00.00	4220 4475	5118.00.00	4200 1325	5741.10.00	298 4511
3537.00.00	4221 1146	5118.00.00	4200 1326	5741.10.00	4249 3782
3537.00.00	4221 1148	5118.00.00	4208 6458	5741.10.00	483 3821
3559.00.00	445 7748	5119.00.00	4100 5463	5741.10.00	483 3826
3559.00.00	9319 1941	5119.00.00	813 1582	5741.10.00	483 3828
3567.20.00	343 57 88	5119.00.00	813 2397	5741.10.00	812 2755
3567.20.00	4204 2912	5120.00.00	0813 7026	5741.20.00	298 0323
3590.20.00	343 5786	5120.00.00	4100 2770	5741.20.00	4248 3520
3590.20.00	798 1909	5120.00.00	4100 9665	5741.20.00	4249 3781
3590.20.00	8602 7074	5120.00.00	4102 8598	5742.20.00	298 0875
3744.96.00	9319 2618	5120.00.00	4102 8600	5743.10.00	298 4061
3765.96.00	4249 3431	5120.00.00	4103 4479	5743.10.00	4248 9395
3765.96.00	9319 2619	5120.00.00	4104 2050	5743.10.00	4249 1957
4163.20.00	4253 0316	5120.45.00	9316 1959	5743.10.00	480 2444
4163.20.00	4253 8047	5120.90.00	9316 1631	5743.10.00	483 3830
4163.20.00	9315 7156	5120.90.00	9316 1638	5743.10.00	819 0225
4569.96.00	500 333 284	5121.00.00	471 6271	5743.20.00	296 6252
4746.20.00	4248 7165	5121.90.00	296 8454	5743.20.00	296 9808
4746.20.00	855 8527	5122.00.00	477 3359	5743.20.00	4248 3386
4746.20.00	9319 4626	5122.00.00	483 4037	5743.20.00	4248 8269
5081.00.00	4212 5057	5122.10.00	486 8942	5743.20.00	4248 9573
5081.00.00	471 4134	5122.10.00	858 2333	5743.20.00	4248 9594
5087.00.00	858 7018	5122.20.00	468 8941	5743.20.00	4249 1638
5094.00.00	248 3652	5122.20.00	716 7757	5743.20.00	480 2443
5094.00.00	252 0334	5122.20.00	856 5366	5743.20.00	483 3829
5094.00.00	4203 2936	5122.20.00	858 2332	5743.20.00	812 2752
5095.00.00	252 0336	5123.00.00	485 4874	5746.10.00	296 9507
5095.00.00	4203 2938	5124.00.00	9840 2544	5746.10.00	4248 4887
5096.00.00	4204 2431	5124.00.00	9846 7459	5746.10.00	483 3826
5097.00.00	4200 0486	5126.00.00	471 6799	5746.10.00	812 3394
5097.00.00	4203 4051	5128.96.00	9316 3617	5746.10.00	855 8536
5103.00.00	9848 8010	5142.00.00	855 8522	5746.20.00	296 6321
5104.00.00	4200 0481	5143.00.00	471 1108	5746.20.00	296 6635
5104.00.00	4203 4054	5143.00.00	471 1109	5746.20.00	4248 4886
5105.00.00	4204 1107	5144.00.00	4204 2950	5746.20.00	483 3825

FAD	OEM	FAD	OEM
5746.20.00	819 3645	6423.00.00	4 121 5165
5746.20.00	855 8533	6424.00.00	4 103 2608
5746.20.00	858 2322	6424.00.00	4 103 3237
5805.10.00	4248 0023	6425.20.00	4253 3101
5805.10.00	4253 2543	6425.20.00	4253 3102
5805.10.00	819 3649	6426.20.00	9319 2809
5805.20.00	4248 0024	6427.00.00	9847 5709
5805.20.00	4249 1937	6428.00.00	9849 3054
5856.10.00	468 8949	6429.00.00	5 0032 4282
5856.20.00	468 8948	6430.00.00	4102 8269
5959.90.00	298 0884	6430.00.00	4129 8449
6107.20.00	4210 5474	6432.20.00	4100 2118
6107.20.00	4253 2294	6432.20.00	4120 3863
6341.00.00	9710 4299	6432.20.00	4204 1327
6342.00.00	9847 2466	6432.20.00	4207 9853
6344.00.00	9944 4744	6433.00.00	500 336 085
6359.00.00	4203 7386	6433.00.00	9945 5009
6359.00.00	8601 2923	6434.00.00	4104 2749
6363.00.00	8 601 1651	6435.00.00	5 0404 9893
6364.00.00	247 5843	6436.90.00	9316 1958
6364.00.00	4201 4656	6438.00.00	504 034 521
6364.00.00	4202 6837	6439.00.00	4100 5450
6364.00.00	4202 6840	6439.00.00	4100 5451
6364.00.00	4203 7655	6439.00.00	4103 6944
6364.00.00	4203 7657	6439.00.00	4104 2730
6383.00.00	9847 0968	6439.00.00	816 3773
6395.00.00	9848 4091	6440.00.00	813 7027
6398.00.00	4100 5466	6441.00.00	4100 9961
6398.00.00	4101 6964	6442.00.00	500 338 783
6399.00.00	474 1171	7474.20.00	0928 1792
6402.00.00	5 0030 7556	7474.20.00	928 1792
6402.00.00	9840 2553	7474.20.00	928 1792
6403.00.00	4200 3432		
6404.00.00	485 4871		
6405.00.00	4100 5309		
6405.00.00	4100 5460		
6405.00.00	816 5309		
6414.00.00	4100 5469		
6414.00.00	4101 1476		
6414.00.00	4101 6960		
6414.00.00	4101 6961		
6414.00.00	813 5492		
6415.00.00	4121 4657		
6417.00.00	9844 9025		
6417.00.00	9846 9650		
6418.00.00	4103 6943		
6420.00.00	9847 3328		
6422.00.00	4100 5475		
6422.00.00	4100 6093		

# FAD/KÄSSBOHRER



FAD	OEM	FAD	OEM
3491.00.00	8.226.232.000	5742.20.00	6.851.488.000
3491.00.00	8.226.241.000	5742.20.00	6.851.523.000
3491.00.00	8.226.357.000	5743.10.00	6.851.485.000
3492.00.00	8.226.306.000	5743.10.00	8.226.236.058
3492.00.00	8.226.244.000 D	5743.20.00	6.851.475.000
3492.00.00	8.226.258.000 C	5743.20.00	6.851.480.000
3494.00.00	8.226.259.000	5743.20.00	6.851.484.000
3494.00.00	8.226.262.000	5743.20.00	6.851.531.000
3494.00.00	8.226.259.000 C	5743.20.00	8.226.236.059
3494.00.00	8.226.262.000 C	6042.00.00	8.226.257.000
3497.00.00	8.226.318.000 B	6043.00.00	8.226.261.000 C
3497.00.00	8.226.323.000 B	6045.00.00	8.226.225.000 D
3581.10.00	6.851.490.000	6048.00.00	8.226.238.000 C
3581.20.00	6.851.491.000	6049.00.00	8.226.307.000
3590.20.00	8.321.999.319	6049.00.00	8.226.347.000
4576.00.00	6.284.600.305	6049.00.00	8.226.247.000 C
4911.00.00	8.226.308.000	6197.00.00	6.293.500.606
4911.00.00	8.226.381.000	6197.00.00	8.226.293.000B
4911.00.00	8.226.248.000 C	6909.00.00	628 330 05 03
4911.00.00	8.226.308.000 C		
4911.20.00	68.515.290.000		
4912.00.00	8.226.328.000		
4913.00.00	8.226.356.000		
4914.00.00	8.226.380.000		
4914.00.00	8.226.380.000 C		
4914.00.00	8.226.380.000.0		
4915.00.00	8.226.330.000		
4595.00.00	628 460 20 05		
4920.00.00	8.226.355.000		
4920.00.00	82.262.800.000		
4920.00.00	82.263.550.000		
4920.00.00	8.226.280.000 B		
4920.00.00	8.226.280.000 C		
5170.96.00	82 262 320 660		
5686.00.00	8.226.137.000		
5686.00.00	8.226.147.000 C		
5686.00.00	8.226.305.000 C		
5686.00.00	8.226.313.000 C		
5687.00.00	8.226.138.000		
5687.00.00	8.226.148.000 C		
5741.20.00	6.851.517.000		
5742.10.00	6.851.446.000		
5742.10.00	6.851.459.000		
5742.10.00	6.851.479.000		
5742.10.00	6.851.487.000		
5742.10.00	6.851.532.000		
5742.20.00	6.851.447.000		
5742.20.00	6.851.478.000		
5742.20.00	6.851.486.000		



FAD	OEM
3590.20.00	5006 070 08
3903.20.00	10220897
4484.96.00	5211 543
4484.96.00	5211 543 08
5743.10.00	5718 665 08
5743.20.00	5718 666 08
6027.00.00	5211 435 08
6027.10.00	5708 161 08
6027.20.00	5708 160 08
6100.00.00	5211 439
6101.00.00	5211 440 08
6102.00.00	5211 441
6102.00.00	5211 441 08
6103.00.00	5211 448
6103.00.00	5211 448 08
6104.10.00	5708 197 08
6104.20.00	5708 196 08
6105.00.00	5211 434
6105.00.00	5211 434 08
6106.00.00	5211 438
6106.00.00	5211 438 08
6106.10.00	5708 159 08
6106.20.00	5708 158 08
6321.00.00	5211 346 77
7474.20.00	7250 510
7474.20.00	7250 510 08

FAD	OEM	FAD	OEM	FAD	OEM
3500.90.00	81.43270.6047	4115.00.00	85.46610.6030	4141.00.00	85.46610.6105
3581.20.00	81.95301.0022	4115.00.00	85.46610.6102	4141.00.00	85.46610.6141
3581.20.00	81.95301.6297	4115.00.00	85.46610.6201	4143.00.00	85.46610.6107
3590.20.00	81.95301.0038	4116.00.00	81.46610.6753	4143.00.00	85.46610.6143
3590.20.00	81.95301.0045	4116.00.00	81.46610.6754	4145.00.00	81.46610.6578
3590.20.00	81.95301.6016	4116.00.00	85.46610.6104	4145.00.00	81.46610.6798
3590.20.00	81.95301.6169	4117.00.00	85.46610.6021	4145.00.00	81.46610.6876
3590.20.00	81.95301.6172	4117.00.00	85.46610.6121	4146.00.00	85.46610.6012
3590.20.00	81.95301.6176	4117.00.00	85.46610.6140	4146.00.00	85.46610.6112
3698.00.00	81.43230.6037	4119.00.00	81.46710.6851	4146.00.00	85.46610.6142
3698.90.00	81.43230.6043	4119.00.00	81.46710.6852	4146.00.00	85.46610.6212
3765.96.00	81.43270.6040	4119.00.00	81.46711.6719	4147.00.00	81.46711.6771
3765.96.00	81.43270.6045	4119.00.00	81.46711.6729	4147.00.00	81.46711.6877
3776.00.00	81.46710.6176	4123.00.00	81.46710.6453	4147.00.00	81.46711.6878
3776.00.00	81.46710.6340	4123.00.00	81.46710.6457	4147.00.00	81.46711.6879
3776.00.00	81.46710.6344	4123.00.00	81.46710.6458	4148.00.00	81.46711.6802
3776.00.00	81.46710.6422	4123.00.00	81.46710.6875	4148.00.00	81.46711.6804
3777.00.00	81.46710.6175	4123.00.00	81.46710.6881	4148.00.00	81.46711.6808
3777.00.00	81.46710.6242	4123.00.00	81.46711.6765	4148.00.00	81.46711.6891
3777.00.00	81.46710.6251	4123.00.00	81.46711.6766	4148.00.00	81.46711.6892
3777.00.00	81.46710.6251	4123.00.00	81.46711.6767	4148.00.00	81.46711.6895
3777.00.00	81.46710.6420	4126.20.00	81.95301.6286	4149.00.00	85.46610.6018
4094.00.00	81.46710.6918	4130.00.00	81.43250.6014	4149.00.00	85.46610.6118
4094.00.00	81.46711.6740	4131.00.00	81.46611.6199	4149.00.00	85.46610.6152
4096.00.00	81.46711.6770	4131.00.00	81.46611.6200	4149.00.00	85.46610.6218
4096.00.00	81.46711.6772	4132.00.00	81.46711.6711	4151.00.00	85.43270.6001
4096.00.00	81.46711.6782	4133.00.00	81.46710.6966	4152.00.00	81.46610.6281
4096.00.00	81.46711.6783	4133.00.00	81.46711.6714	4152.00.00	81.46610.6300
4096.00.00	81.46711.6874	4134.00.00	81.46710.6122	4152.00.00	81.46610.6303
4096.00.00	81.46711.6875	4134.00.00	81.46710.6167	4152.00.00	81.46610.6304
4096.00.00	81.46711.6876	4134.00.00	81.46710.6194	4152.00.00	81.46610.6327
4097.00.00	81.46610.6606	4134.00.00	81.46710.6195	4152.00.00	81.46610.6329
4098.00.00	82.46610.6049	4134.00.00	81.46710.6378	4153.00.00	81.46611.6151
4099.00.00	82.46610.6050	4134.00.00	81.46710.6379	4153.00.00	82.46610.6184
4104.00.00	81.46710.6117	4134.00.00	81.46710.6380	4153.00.00	81.46610.6185
4104.00.00	81.46710.6281	4134.00.00	81.46710.6830	4156.00.00	85.46610.6162
4104.00.00	81.46710.6282	4134.00.00	81.46710.6836	4157.00.00	85.46610.6163
4104.00.00	81.46710.6370	4134.00.00	81.46710.6912	4158.00.00	85.46610.6244
4104.00.00	81.46710.6371	4134.00.00	81.46711.6736	4159.00.00	85.46610.6247
4104.00.00	81.46710.6372	4135.00.00	81.46711.6860	4162.00.00	81.46710.6314
4107.00.00	81.43220.6189	4135.00.00	81.46711.6861	4162.00.00	81.46710.6315
4108.00.00	81.43220.6161	4135.00.00	81.46711.6921	4162.00.00	81.46710.6316
4108.00.00	81.43220.6190	4136.00.00	81.46610.6790	4163.20.00	81.95301.6232
4109.20.00	81.95301.6219	4136.00.00	81.46610.6791	4164.00.00	81.46610.6565
4109.20.00	81.95301.6225	4136.00.00	82.46610.6191	4164.00.00	81.46610.6567
4109.20.00	81.95301.6226	4137.00.00	81.43250.6011	4164.00.00	81.46610.6569
4109.20.00	81.95301.6267	4137.00.00	81.43250.6016	4164.00.00	81.46610.6621
4109.20.00	81.95301.6291	4138.00.00	85.46610.6108	4164.00.00	81.46610.6639
4112.00.00	81.43220.6196	4138.00.00	85.46610.6144	4165.00.00	81.46610.6425
4115.00.00	81.46610.6725	4138.00.00	85.46610.6208	4165.00.00	81.46610.6436

FAD	OEM	FAD	OEM	FAD	OEM
4165.00.00	81.46610.6515	5245.00.00	81.46710.6240	5564.00.00	81.46710.6266
4165.00.00	81.46610.6538	5245.00.00	81.46710.6409	5564.00.00	81.46710.6359
4165.00.00	81.46610.6597	5245.00.00	81.46710.6410	5564.00.00	81.46710.6360
4165.00.00	81.46610.6615	5259.00.00	81.46610.6656	5564.00.00	81.46710.6362
4165.00.00	81.46610.6634	5259.00.00	81.46610.6659	5564.00.00	81.46710.6396
4166.00.00	81.46610.6584	5259.00.00	81.46611.6006	5564.00.00	81.46710.6397
4167.00.00	81.46610.6660	5323.96.00	81.43230.6051	5564.00.00	81.46710.6816
4168.00.00	82.46610.6079	5323.96.00	81.43230.6068	5564.00.00	81.46710.6904
4168.00.00	82.46610.6143	5323.96.00	81.43270.6064	5564.00.00	81.46711.6724
4168.00.00	82.46610.6153	5332.00.00	81.46710.6865	5594.96.00	81.43220.6203
4169.00.00	81.46610.6761	5332.00.00	81.46710.6866	5741.10.00	81.95301.0013
4492.96.00	81.43270.6105	5332.00.00	81.46711.6728	5741.10.00	81.95301.0074
4569.96.00	85.43220.6002	5333.00.00	81.46710.6434	5741.10.00	81.95301.6068
5117.96.00	81.43230.6061	5333.00.00	81.46710.6435	5741.10.00	81.95301.6163
5170.96.00	81.43220.6055	5333.00.00	81.46710.6456	5741.10.00	90.80415.3107
5170.96.00	81.43220.6073	5335.00.00	81.46610.6129	5741.10.00	90.80415.3113
5210.00.00	81.46710.6236	5336.20.00	81.95301.0040	5742.10.00	81.95301.6070
5210.00.00	81.46710.6267	5337.20.00	81.95301.0041	5742.10.00	81.95301.6261
5210.00.00	81.46710.6268	5339.00.00	81.43220.6168	5742.20.00	81.95301.0025
5210.00.00	81.46710.6355	5520.00.00	81.46610.6088	5742.20.00	90.80415.4117
5210.00.00	81.46710.6356	5522.00.00	81.43718.6006	5743.10.00	81.95301.0015
5210.00.00	81.46710.6373	5522.00.00	81.43718.6007	5743.10.00	81.95301.0083
5210.00.00	81.46711.6723	5522.96.00	81.43718.6009	5743.10.00	81.95301.0097
5215.00.00	81.46710.6388	5524.90.00	81.43270.6065	5743.10.00	81.95301.6030
5215.00.00	81.46710.6393	5531.96.00	81.43220.6053	5743.10.00	81.95301.6043
5216.00.00	81.46710.6112	5532.00.00	81.46610.6414	5743.10.00	81.95301.6050
5216.00.00	81.46710.6163	5535.00.00	81.43315.6012	5743.10.00	81.95301.6054
5216.00.00	81.46710.6165	5535.96.00	81.95302.0039	5743.10.00	81.95301.6087
5216.00.00	81.46710.6198	5536.00.00	81.46610.6360	5743.10.00	81.95301.6091
5216.00.00	81.46710.6353	5536.00.00	81.46610.6361	5743.10.00	81.95301.6155
5216.00.00	81.46710.6354	5536.00.00	81.46610.6721	5743.10.00	81.95301.6168
5216.00.00	81.46710.6361	5536.00.00	81.46610.6721	5743.10.00	81.95301.6179
5216.00.00	81.46711.6725	5536.00.00	81.46610.6722	5743.10.00	81.95301.6237
5216.00.00	81.46711.6820	5536.00.00	81.46610.6723	5743.10.00	81.95301.6279
5219.00.00	81.46610.6159	5536.20.00	81.95301.6263	5743.20.00	81.95301.0016
5219.00.00	81.46610.6200	5537.00.00	81.43230.6037	5743.20.00	81.95301.0084
5219.00.00	81.46611.6064	5538.00.00	81.43220.6102	5743.20.00	81.95301.6048
5219.00.00	81.46710.6319	5538.00.00	81.43220.6148	5743.20.00	81.95301.6049
5235.00.00	81.46610.6424	5538.00.00	81.43220.6152	5743.20.00	81.95301.6053
5235.00.00	81.46610.6432	5538.00.00	81.43220.6186	5743.20.00	81.95301.6090
5235.00.00	81.46610.6434	5539.00.00	81.46610.6089	5743.20.00	81.95301.6108
5235.00.00	81.46610.6437	5546.00.00	81.43220.6096	5743.20.00	81.95301.6112
5235.00.00	81.46610.6513	5546.00.00	81.43220.6097	5743.20.00	81.95301.6126
5235.00.00	81.46610.6537	5546.00.00	81.43220.6098	5743.20.00	81.95301.6143
5235.00.00	81.46610.6596	5546.00.00	81.43220.6129	5743.20.00	81.95301.6149
5235.00.00	81.46610.6614	5546.00.00	81.43230.6014	5743.20.00	81.95301.6154
5235.00.00	81.46610.6635	5546.00.00	81.43230.6030	5743.20.00	81.95301.6156
5235.00.00	81.46610.6735	5554.00.00	81.43250.6007	5743.20.00	81.95301.6178
5235.00.00	81.46610.6743	5564.00.00	81.46710.6131	5743.20.00	81.95301.6194
5245.00.00	81.46710.6238	5564.00.00	81.46710.6265	5743.20.00	81.95301.6224

FAD	OEM	FAD	OEM	FAD	OEM
5743.20.00	81.95301.6234	5933.00.00	81.46710.6172	5944.00.00	81.43270.6075
5743.20.00	81.95301.6274	5933.00.00	81.46710.6295	5944.00.00	81.43270.6077
5743.20.00	81.95301.6278	5933.00.00	81.46710.6337	5944.00.00	81.43270.6081
5746.10.00	81.95301.0079	5933.00.00	81.46710.6345	5944.00.00	81.43270.9056
5746.10.00	81.95301.6139	5933.00.00	81.46710.6421	5944.96.00	81.43270.6079
5746.10.00	81.95301.6222	5933.00.00	81.46710.6451	5945.90.00	81.95301.6133
5746.20.00	81.95301.6060	5933.00.00	81.46710.6876	5946.00.00	81.46610.6147
5746.20.00	81.95301.6135	5934.00.00	81.46710.6081	5946.00.00	81.46610.6195
5746.20.00	81.95301.6140	5934.00.00	81.46710.6137	5946.00.00	81.46610.6201
5746.20.00	81.95301.6249	5934.00.00	81.46710.6173	5946.00.00	81.46610.6257
5805.10.00	81.95301.0078	5934.00.00	81.46710.6294	5946.00.00	81.46610.6415
5805.10.00	81.95301.6141	5934.00.00	81.46710.6419	5946.00.00	81.46610.6476
5805.10.00	81.95301.6304	5934.00.00	81.46710.6444	5946.00.00	81.46610.6503
5805.10.00	81.95301.6322	5934.00.00	81.46710.6877	5946.00.00	81.46610.6532
5805.20.00	81.95301.0077	5934.00.00	81.46710.6879	5946.00.00	81.46610.6594
5805.20.00	81.95301.6134	5934.00.00	81.46711.6759	5946.00.00	81.46610.6608
5805.20.00	81.95301.6142	5934.00.00	81.46711.6760	5946.00.00	81.46610.6630
5805.20.00	81.95301.6321	5934.00.00	81.46711.6761	5948.00.00	81.43220.6025
5810.20.00	81.95301.0022	5937.00.00	81.43220.6096	5950.00.00	81.43220.6067
5856.20.00	81.95301.6184	5937.00.00	81.43220.6097	5950.00.00	81.43220.6068
5910.00.00	81.43220.6010	5937.00.00	81.43220.6098	5950.00.00	81.43220.6090
5910.00.00	81.43220.6012	5937.00.00	81.43220.6129	5950.00.00	81.43220.6092
5910.00.00	81.43220.6013	5937.00.00	81.43230.6014	5950.00.00	81.43220.9092
5910.00.00	81.43220.6020	5937.00.00	81.43230.6030	5951.00.00	81.43220.6042
5910.00.00	81.43220.6028	5938.00.00	81.43220.6070	5952.00.00	81.43220.6043
5910.00.00	81.43220.6035	5938.00.00	81.43220.6071	5956.00.00	81.43220.6099
5910.00.00	81.43220.6040	5938.00.00	81.43220.6072	5956.00.00	81.43220.6100
5910.00.00	81.43220.6041	5938.00.00	81.43220.6091	5959.00.00	81.43220.6096
5910.00.00	81.43220.6052	5938.00.00	81.43220.6093	5959.00.00	81.43220.6097
5910.00.00	81.43220.6056	5940.00.00	81.43230.6015	5959.00.00	81.43220.6098
5910.00.00	81.43230.6018	5940.00.00	81.43230.6031	5959.00.00	81.43220.6129
5921.00.00	81.43220.6096	5940.00.00	81.43230.9031	5959.00.00	81.43230.6014
5921.00.00	81.43220.6097	5941.00.00	81.43220.6096	5959.00.00	81.43230.6030
5921.00.00	81.43220.6098	5941.00.00	81.43220.6097	5959.90.00	81.43220.6108
5921.00.00	81.43220.6129	5941.00.00	81.43220.6098	5975.00.00	81.46610.6374
5921.00.00	81.43230.6014	5941.00.00	81.43220.6129	5975.00.00	81.46611.6019
5921.00.00	81.43230.6030	5941.00.00	81.43230.6014	5976.00.00	81.46710.6459
5922.00.00	81.43230.6038	5941.00.00	81.43230.6030	5976.00.00	81.46710.6818
5922.00.00	81.43230.6039	5943.00.00	81.43270.6030	5976.00.00	81.46710.6908
5932.00.00	81.46610.6196	5943.00.00	81.43270.6034	5977.00.00	81.46710.6459
5932.00.00	81.46610.6202	5943.00.00	81.43270.6057	6173.00.00	81.43220.6106
5932.00.00	81.46610.6409	5943.00.00	81.43270.6074	6173.00.00	81.43230.6049
5932.00.00	81.46610.6504	5943.00.00	81.43270.6076	6179.00.00	81.46710.6037
5932.00.00	81.46610.6531	5943.00.00	81.43270.6078	6179.00.00	81.46710.6054
5932.00.00	81.46610.6593	5943.00.00	81.43270.6082	6179.00.00	81.46710.6059
5932.00.00	81.46610.6609	5943.00.00	81.43270.9034	6179.00.00	81.46710.6145
5932.00.00	81.46610.6631	5943.00.00	81.43270.9078	6179.00.00	81.46710.6302
5932.00.00	81.46610.6740	5943.90.00	81.95301.6132	6181.00.00	81.43220.6129
5933.00.00	81.46710.6080	5944.00.00	81.43270.6056	6186.00.00	81.43220.6140
5933.00.00	81.46710.6136	5944.00.00	81.43270.6067	6186.00.00	81.43220.9140

FAD	OEM	FAD	OEM	FAD	OEM
6188.00.00	81.43220.6236	6322.00.00	81.46711.6734	6791.00.00	81.46711.6823
6188.00.00	81.43220.6267	6322.00.00	81.46711.6833	6792.00.00	81.46710.6862
6188.00.00	81.43220.6272	6323.00.00	81.46711.6933	6792.00.00	81.46710.6863
6189.00.00	81.43270.6096	6323.00.00	81.46711.6934	6792.00.00	81.46710.6864
6191.00.00	81.43220.6174	6324.00.00	85.46610.6056	6792.00.00	81.46710.6909
6194.00.00	81.43220.6151	6325.00.00	81.46610.6803	6792.00.00	81.46710.6910
6194.00.00	81.43220.6183	6425.20.00	81.95301.6219	6792.00.00	81.46710.6974
6194.00.00	81.43220.6276	6425.20.00	81.95301.6225	6792.00.00	81.46711.6712
6196.00.00	81.46611.6096	6425.20.00	81.95301.6226	6792.00.00	81.46711.6786
6198.00.00	81.46610.6708	6425.20.00	81.95301.6267	7474.20.00	82.95301.0011
6198.00.00	81.46611.6067	6425.20.00	81.95301.6291	7685.00.00	81.46610.6767
6201.00.00	81.43220.6247	6680.00.00	85.46610.6160	7685.00.00	81.46610.6768
6202.00.00	81.46610.6716	6680.00.00	85.46610.6246	7685.00.00	81.46611.6014
6202.00.00	81.46611.6068	6681.00.00	81.46610.6648		
6203.00.00	81.46610.6689	6681.00.00	81.46611.6150		
6203.00.00	81.46610.6720	6683.00.00	81.43220.6258		
6206.00.00	81.46610.6376	6683.00.00	81.43220.6264		
6207.00.00	81.46710.6443	6683.00.00	81.43220.6275		
6211.00.00	81.46610.6756	6683.00.00	81.43220.6278		
6212.00.00	81.46610.6779	6683.00.00	81.43220.6279		
6212.00.00	81.46610.6780	6684.00.00	81.46611.6138		
6212.00.00	81.46610.6782	6684.00.00	81.46611.6139		
6213.00.00	81.46710.6436	6684.00.00	81.46611.6201		
6214.00.00	81.46710.6438	6684.00.00	81.46611.6202		
6214.00.00	81.46710.6439	6687.00.00	81.46611.6131		
6215.00.00	81.46710.6994	6688.00.00	81.46611.6108		
6215.00.00	81.46711.6726	6689.00.00	81.46611.6045		
6216.00.00	81.46611.6197	6690.00.00	81.46711.6803		
6216.00.00	81.46611.6198	6690.00.00	81.46711.6893		
6218.00.00	81.46711.6773	6690.00.00	81.46711.6894		
6218.00.00	81.46711.6858	6690.00.00	81.46711.6896		
6219.00.00	81.43270.6117	6691.00.00	81.46610.6548		
6222.00.00	81.46710.6418	6691.00.00	81.46611.6065		
6223.00.00	81.46611.6133	6692.00.00	81.43220.6015		
6224.00.00	81.46611.6004	6692.00.00	81.43220.6047		
6224.00.00	81.46611.6005	6693.00.00	81.43220.6229		
6224.00.00	81.46611.6005	6693.00.00	81.43220.6304		
6252.00.00	81.46611.6217	6693.00.00	81.43220.6305		
6252.00.00	83.46610.6001	6694.00.00	81.46610.6579		
6321.00.00	81.46611.6157	6694.00.00	81.46711.6720		
6321.00.00	81.46611.6158	6695.00.00	85.43220.6001		
6321.00.00	81.46611.6159	6696.00.00	85.43220.6004		
6322.00.00	81.46710.6253	6697.00.00	81.46710.6237		
6322.00.00	81.46710.6254	6697.00.00	81.46710.6239		
6322.00.00	81.46710.6255	6697.00.00	81.46710.6241		
6322.00.00	81.46710.6375	6698.00.00	36.46710.6003		
6322.00.00	81.46710.6376	6698.00.00	36.46710.6005		
6322.00.00	81.46710.6377	6699.00.00	36.46710.6000		
6322.00.00	81.46710.6928	6791.00.00	81.46711.6715		

FAD	OEM	FAD	OEM	FAD	OEM
1074.20.00	000 460 72 48	3431.00.00	383 330 03 11	3692.00.00	309 330 21 03
1074.20.00	001 330 48 35	3431.00.00	654 330 00 11	3692.10.00	000 330 26 35
1074.20.00	460 330 12 35	3431.00.00	654 330 01 11	3692.10.00	000 330 69 35
1701.10.00	000 338 08 10	3432.00.00	653 330 00 11	3692.10.00	001 330 08 35
1701.10.00	000 338 20 10	3433.00.00	620 330 02 11	3692.10.00	001 330 10 35
1701.10.00	000 338 50 10	3434.00.00	655 330 00 11	3692.20.00	000 330 27 35
1701.10.00	000 338 53 10	3435.00.00	620 330 03 11	3692.20.00	000 330 70 35
1701.20.00	000 338 54 10	3444.00.00	357 330 02 03	3692.20.00	001 330 07 35
1702.00.00	124 330 08 03	3444.00.00	357 330 04 03	3692.20.00	001 330 09 35
1702.20.00	000 338 51 10	3444.00.00	357 330 05 03	3693.00.00	363 460 00 05
1703.00.00	631 330 03 03	3471.00.00	395 350 05 06	3697.00.00	381 350 03 06
1703.10.00	631 330 04 10	3492.00.00	634 460 05 05	3697.00.00	385 350 02 06
1703.20.00	631 338 03 10	3500.90.00	000 350 01 05	3699.00.00	625 350 01 06
1704.00.00	631 330 05 03	3500.95.00	000 586 19 33	3708.00.00	619 460 25 05
1704.00.00	631 330 07 03	3503.00.00	383 350 01 05	3708.00.00	619 460 29 05
1704.20.00	631 330 04 35	3503.00.00	393 350 52 05	3708.00.00	619 460 52 05
1705.00.00	631 330 04 03	3503.00.00	393 350 53 05	3713.10.00	000 330 33 35
1706.00.00	631 330 06 03	3503.00.00	393 350 54 05	3713.20.00	000 330 14 35
1708.00.00	608 330 04 03	3503.00.00	393 350 55 05	3716.00.00	391 330 04 03
1711.20.00	901 460 01 48	3503.00.00	653 350 01 05	3716.00.00	391 330 07 03
1711.20.00	901 460 03 48	3503.00.00	653 353 00 05	3716.00.00	391 330 09 03
1715.10.00	000 338 43 10	3503.00.00	655 350 03 05	3716.00.00	391 330 11 03
1715.10.00	000 338 45 10	3503.00.00	658 350 00 05	3720.00.00	387 460 00 05
1715.10.00	000 338 60 10	3581.20.00	000 460 17 48	3722.00.00	389 330 01 03
1715.10.00	000 338 62 10	3590.20.00	000 268 01 81	3723.00.00	352 460 37 05
1715.20.00	000 338 42 10	3590.20.00	000 268 48 89	3723.00.00	352 460 66 05
1715.20.00	000 338 44 10	3590.20.00	000 268 52 89	3723.00.00	352 460 71 05
1715.20.00	000 338 61 10	3601.38.00	322 330 10 11	3724.00.00	365 460 06 05
3301.00.00	945 330 00 07	3601.38.00	357 330 31 11	3725.00.00	366 460 07 05
3302.00.00	000 360 098 524	3602.38.00	317 350 07 06	3726.00.00	366 460 08 05
3302.00.00	000 390 098 524	3602.38.00	600 330 01 11	3728.00.00	335 460 05 05
3302.00.00	941 330 00 11	3604.38.00	317 350 06 06	3728.00.00	335 460 07 05
3302.00.00	SA 508 316 / 01	3604.38.00	357 330 34 11	3728.00.00	335 460 08 05
3303.00.00	941 330 00 07	3605.38.00	301 330 00 11	3730.00.00	346 330 45 03
3304.00.00	945 330 00 11	3605.38.00	600 330 00 11	3730.00.00	346 330 51 03
3304.00.00	SA 508 316 / 02	3608.38.00	317 330 02 11	3733.00.00	352 460 35 05
3305.00.00	355 460 15 05	3609.38.00	317 330 04 11	3734.00.00	302 330 01 03
3305.00.00	355 460 59 05	3609.38.00	357 330 42 11	3734.00.00	302 330 04 03
3305.00.00	355 460 60 05	3690.00.00	395 350 10 06	3734.00.00	302 330 07 03
3306.00.00	675 460 10 05	3690.00.00	624 350 02 06	3735.00.00	302 330 03 03
3306.00.00	675 460 16 05	3690.00.00	659 350 13 06	3735.00.00	302 330 06 03
3306.00.00	675 460 22 05	3690.00.00	659 350 36 06	3735.00.00	302 330 18 03
3306.00.00	675 460 28 05	3692.00.00	309 330 12 03	3736.00.00	352 460 10 05
3307.00.00	676 460 01 05	3692.00.00	309 330 13 03	3736.00.00	352 460 19 05
3307.00.00	676 460 06 05	3692.00.00	309 330 14 03	3736.00.00	352 460 27 05
3307.00.00	676 460 11 05	3692.00.00	309 330 16 03	3736.00.00	352 460 44 05
3307.00.00	676 460 15 05	3692.00.00	309 330 17 03	3736.00.00	352 460 54 05
3310.00.00	307 330 01 11	3692.00.00	309 330 18 03	3739.00.00	346 330 5003
3310.00.00	357 330 36 11	3692.00.00	309 330 19 03	3742.00.00	393 320 01 32
3310.96.00	000 330 00 75	3692.00.00	309 330 20 03	3742.00.00	655 350 00 06

FAD	OEM	FAD	OEM	FAD	OEM
3742.00.00	658 350 00 06	3768.00.00	624 350 04 06	3967.00.00	357 460 14 05
3742.00.00	658 350 02 06	3768.00.00	659 350 15 06	3967.00.00	357 460 15 05
3744.00.00	395 350 02 06	3768.00.00	659 350 38 06	3968.00.00	385 330 02 03
3744.00.00	659 350 01 06	3769.00.00	395 350 13 06	3968.00.00	385 330 08 03
3744.00.00	659 350 24 06	3769.00.00	624 350 05 06	3968.00.00	385 330 16 03
3744.96.00	000 350 06 13	3769.00.00	659 350 16 06	3968.00.00	385 330 18 03
3744.96.00	000 586 11 35	3769.00.00	659 350 39 06	3969.00.00	617 460 24 05
3745.00.00	395 350 07 06	3769.96.00	000 350 01 13	3969.00.00	617 460 34 05
3745.00.00	659 350 04 06	3914.00.00	352 460 23 05	3971.00.00	620 460 04 05
3745.00.00	659 350 27 06	3914.00.00	352 460 31 05	3971.00.00	620 460 08 05
3751.00.00	385 350 01 06	3914.00.00	352 460 32 05	3971.00.00	620 460 29 05
3751.00.00	395 320 03 32	3914.00.00	352 460 48 05	3971.00.00	620 460 30 05
3752.00.00	395 320 01 32	3914.00.00	352 460 49 05	3972.00.00	675 460 12 05
3753.00.00	393 320 02 32	3914.00.00	352 460 56 05	3972.00.00	675 460 18 05
3754.00.00	393 320 04 32	3916.00.00	668 460 05 05	3972.00.00	675 460 24 05
3755.00.00	395 320 14 32	3916.00.00	668 460 07 05	3972.00.00	675 460 30 05
3755.90.00	000 350 02 13	3916.00.00	668 460 09 05	3973.00.00	001 460 29 05
3755.90.00	000 350 03 05	3916.00.00	668 460 11 05	3973.00.00	001 460 30 05
3755.90.00	000 350 05 05	3917.00.00	668 460 15 05	3974.00.00	625 330 15 03
3755.90.00	000 586 14 33	3917.00.00	668 460 17 05	3974.00.00	625 330 16 03
3755.95.00	000 586 15 33	3917.00.00	668 460 19 05	3974.00.00	625 330 24 03
3756.00.00	343 320 16 32	3918.00.00	313 460 01 05	3974.00.00	625 330 25 03
3756.00.00	343 320 17 32	3919.00.00	355 460 09 05	3975.00.00	622 460 04 05
3756.00.00	343 320 18 32	3919.00.00	355 460 35 05	3975.00.00	622 460 14 05
3757.00.00	352 350 04 06	3919.00.00	355 460 51 05	3975.00.00	622 460 15 05
3757.90.00	000 586 01 32	3922.00.00	352 460 28 05	3976.00.00	622 460 02 05
3757.95.00	000 586 07 32	3922.00.00	352 460 57 05	3976.00.00	622 460 03 05
3758.00.00	393 320 03 32	3923.00.00	625 460 44 05	3976.00.00	622 460 09 05
3759.00.00	624 350 01 06	3924.00.00	602 330 09 03	3976.00.00	622 460 10 05
3759.00.00	659 350 12 06	3924.00.00	602 330 10 03	3977.00.00	625 330 26 03
3759.00.00	659 350 35 06	3924.00.00	602 330 53 03	3977.00.00	625 330 27 03
3760.00.00	659 350 17 06	3924.00.00	602 330 54 03	3978.00.00	617 330 02 03
3761.00.00	624 350 03 06	3935.96.00	000 330 14 11	3978.00.00	617 330 03 03
3761.00.00	659 350 14 06	3936.96.00	000 350 21 05	3979.00.00	947 350 00 05
3761.00.00	659 350 37 06	3937.00.00	625 330 09 03	3979.00.00	948 350 06 05
3762.00.00	395 350 11 06	3937.00.00	625 330 12 03	3979.00.00	948 350 12 05
3762.00.00	395 350 12 06	3937.00.00	944 330 02 03	3979.00.00	948 350 13 05
3762.00.00	659 350 09 06	3938.00.00	620 460 24 05	3987.00.00	391 460 09 05
3762.00.00	659 350 32 06	3938.00.00	620 460 26 05	3987.00.00	391 460 17 05
3764.00.00	395 350 08 06	3938.00.00	620 460 40 05	3987.00.00	391 460 18 05
3765.00.00	395 350 00 06	3938.00.00	620 460 41 05	3988.00.00	619 460 04 05
3765.00.00	624 350 00 06	3950.90.00	000 350 14 05	3988.00.00	619 460 19 05
3765.00.00	659 350 11 06	3952.00.00	357 330 17 11	3988.00.00	619 460 45 05
3765.00.00	659 350 34 06	3956.90.00	000 350 02 05	3991.00.00	343 320 16 32
3765.96.00	000 350 04 13	3958.00.00	396 460 30 05	3991.00.00	343 320 17 32
3765.96.00	000 586 12 35	3958.00.00	396 460 48 05	3991.00.00	343 320 18 32
3767.00.00	395 350 11 06	3959.00.00	396 460 31 05	3991.90.00	343 586 00 32
3767.00.00	395 350 12 06	3959.00.00	396 460 49 05	3991.95.00	000 586 06 32
3767.00.00	659 350 09 06	3965.20.00	440 460 03 48	3992.00.00	343 320 16 32
3767.00.00	659 350 32 06	3965.20.00	440 460 05 48	3992.00.00	343 320 17 32

FAD	OEM	FAD	OEM	FAD	OEM
3992.00.00	343 320 18 32	4489.10.00	000 460 84 48	4529.00.00	000 460 72 05
3999.00.00	619 460 06 05	4489.10.00	001 460 07 48	4529.00.00	001 460 67 05
3999.00.00	619 460 21 05	4489.20.00	000 460 48 48	4531.00.00	000 460 98 05
3999.00.00	619 460 47 05	4489.20.00	001 460 06 48	4531.00.00	000 460 99 05
4450.00.00	941 330 00 03	4490.96.00	000 350 29 05	4532.00.00	972 460 14 05
4450.00.00	941 330 01 03	4492.96.00	000 350 28 05	4532.00.00	972 460 16 05
4450.00.00	941 330 02 03	4495.00.00	000 460 92 05	4533.00.00	001 460 03 05
4450.00.00	941 330 03 03	4495.00.00	000 460 93 05	4533.00.00	001 460 04 05
4451.00.00	945 330 02 03	4495.00.00	001 460 69 05	4534.00.00	667 460 15 05
4451.00.00	945 330 03 03	4496.00.00	942 330 00 03	4534.00.00	667 460 17 05
4451.00.00	945 330 05 03	4496.00.00	942 330 01 03	4535.00.00	668 460 21 05
4457.00.00	942 330 03 03	4496.00.00	942 330 02 03	4535.00.00	668 460 22 05
4457.00.00	942 330 04 03	4496.00.00	942 330 07 03	4536.00.00	631 460 07 05
4457.00.00	942 330 16 03	4496.00.00	942 330 11 03	4538.00.00	942 350 05 05
4458.00.00	625 330 03 03	4504.00.00	001 460 62 05	4538.00.00	942 350 08 05
4458.00.00	625 330 20 03	4504.00.00	002 460 12 05	4539.00.00	002 460 49 05
4458.00.00	625 330 21 03	4505.00.00	001 460 89 05	4539.00.00	002 460 50 05
4458.00.00	625 330 26 03	4505.00.00	002 460 13 05	4541.00.00	002 460 63 05
4458.00.00	625 330 27 03	4510.00.00	001 460 63 05	4545.00.00	001 460 05 05
4458.00.00	942 330 05 03	4510.00.00	001 460 85 05	4545.00.00	001 460 06 05
4458.00.00	942 330 06 03	4511.00.00	949 330 12 03	4546.00.00	619 460 20 05
4458.00.00	942 330 09 03	4511.00.00	949 330 13 03	4546.00.00	619 460 46 05
4459.00.00	942 330 08 03	4511.00.00	949 330 18 03	4548.00.00	001 460 15 05
4459.00.00	949 330 02 03	4512.00.00	396 460 53 05	4548.00.00	001 460 73 05
4459.00.00	949 330 03 03	4513.00.00	972 460 18 05	4548.00.00	375 460 16 05
4459.00.00	949 330 09 03	4513.00.00	972 460 20 05	4549.00.00	002 460 51 05
4471.00.00	970 330 00 03	4514.00.00	970 460 07 05	4549.00.00	002 460 52 05
4471.00.00	970 330 01 03	4514.00.00	970 460 09 05	4550.00.00	424 330 03 03
4471.00.00	970 330 02 03	4515.00.00	001 460 86 05	4551.00.00	001 460 13 05
4471.00.00	970 330 03 03	4515.00.00	001 460 87 05	4551.00.00	001 460 14 05
4471.00.00	970 330 04 03	4516.00.00	080 460 67 05	4551.00.00	002 460 05 05
4474.00.00	975 330 02 03	4519.00.00	001 460 07 05	4551.00.00	003 460 32 05
4474.00.00	975 330 03 03	4519.00.00	001 460 08 05	4552.00.00	406 460 01 05
4474.00.00	975 330 08 03	4519.00.00	001 460 70 05	4553.00.00	945 330 00 03
4474.00.00	975 330 17 03	4522.00.00	949 330 10 03	4553.00.00	945 330 01 03
4480.00.00	942 350 10 05	4522.00.00	949 330 11 03	4553.00.00	945 330 04 03
4480.00.00	944 350 00 05	4522.00.00	949 330 17 03	4553.00.00	945 330 06 03
4480.00.00	947 350 01 05	4524.00.00	003 460 46 05	4554.00.00	000 460 43 05
4480.00.00	947 350 10 05	4524.00.00	974 460 10 05	4554.00.00	625 460 48 05
4481.00.00	944 350 03 05	4524.00.00	974 460 12 05	4556.00.00	000 460 45 05
4481.00.00	944 350 05 05	4525.00.00	002 460 96 05	4556.00.00	002 460 83 05
4481.00.00	944 350 06 05	4525.00.00	002 460 97 05	4556.00.00	625 460 80 05
4481.00.00	947 350 09 05	4526.00.00	355 460 23 05	4558.20.00	001 460 15 48
4481.00.00	948 350 04 05	4526.00.00	355 460 28 05	4558.20.00	001 460 16 48
4481.00.00	948 350 30 05	4526.00.00	355 460 47 05	4559.00.00	949 330 04 03
4482.96.00	000 350 22 05	4527.00.00	002 460 47 05	4559.00.00	949 330 05 03
4483.96.00	000 350 23 05	4527.00.00	002 460 48 05	4559.00.00	949 330 08 03
4484.96.00	000 350 24 05	4528.00.00	000 460 95 05	4559.00.00	949 330 14 03
4488.00.00	357 333 06 05	4528.00.00	001 460 71 05	4560.00.00	427 460 00 05
4488.00.00	357 333 09 05	4529.00.00	000 460 71 05	4560.00.00	427 460 01 05



# FAD/MERCEDES-BENZ



FAD	OEM		FAD	OEM		FAD	OEM
4560.00.00	427 460 03 05		4588.00.00	634 326 05 16		5703.00.00	602 330 09 03
4560.00.00	427 460 04 05		4589.00.00	634 326 01 16		5703.00.00	602 330 10 03
4561.00.00	972 460 15 05		4589.00.00	634 326 06 16		5703.00.00	602 330 53 03
4561.00.00	972 460 17 05		4590.20.00	001 330 99 35		5703.00.00	602 330 54 03
4562.00.00	970 460 08 05		4594.00.00	425 460 01 05		5704.00.00	309 330 06 03
4562.00.00	970 460 10 05		4594.00.00	425 460 02 05		5704.00.00	309 330 07 03
4563.00.00	001 460 98 05		4594.00.00	425 460 03 05		5704.00.00	309 330 08 03
4563.00.00	001 460 99 05		4594.00.00	425 460 04 05		5704.00.00	309 330 11 03
4563.00.00	002 460 64 05		4594.00.00	437 460 00 05		5705.00.00	381 350 06 06
4564.00.00	676 460 12 05		4594.00.00	437 460 01 05		5705.00.00	652 350 03 06
4564.00.00	676 460 16 05		4595.00.00	628 460 20 05		5705.00.00	653 350 01 06
4565.00.00	974 460 11 05		4597.00.00	002 460 88 05		5705.96.00	000 350 11 05
4565.00.00	974 460 13 05		4597.00.00	002 460 89 05		5706.00.00	654 350 04 06
4566.00.00	629 350 12 06		4599.00.00	001 460 90 05		5706.00.00	654 350 05 06
4566.00.00	629 350 28 06		4599.00.00	001 460 91 05		5706.00.00	654 352 00 05
4567.00.00	625 330 32 03		4746.20.00	000 330 12 35		5708.00.00	356 350 01 06
4567.00.00	944 330 17 03		4746.20.00	000 330 13 35		5718.00.00	317 460 65 05
4568.00.00	001 460 11 05		4746.20.00	000 330 98 35		5718.00.00	317 460 66 05
4568.00.00	002 460 04 05		5117.96.00	000 330 02 07		5718.00.00	317 460 70 05
4569.96.00	000 330 20 11		5128.96.00	000 330 05 11		5718.00.00	317 460 72 05
4571.00.00	662 460 09 05		5128.96.00	000 330 22 11		5719.00.00	317 460 61 05
4572.00.00	662 460 08 05		5170.96.00	000 350 05 06		5720.00.00	316 460 07 05
4573.00.00	667 460 16 05		5280.00.00	307 460 04 05		5720.00.00	316 460 08 05
4573.00.00	667 460 18 05		5282.00.00	305 330 04 03		5720.00.00	316 460 09 05
4574.00.00	001 460 49 05		5282.00.00	305 330 08 03		5721.00.00	302 460 16 05
4574.00.00	001 460 74 05		5282.00.00	305 330 10 03		5721.00.00	302 460 18 05
4575.20.00	000 460 50 48		5282.00.00	305 330 11 03		5721.00.00	302 460 24 05
4576.00.00	628 460 03 05		5283.00.00	300 460 06 05		5721.00.00	302 460 37 05
4576.00.00	628 460 12 05		5283.00.00	300 460 07 05		5721.00.00	302 460 38 05
4579.00.00	957 460 05 05		5283.00.00	305 460 03 05		5721.00.00	373 460 08 05
4579.00.00	957 460 07 05		5323.96.00	000 330 07 07		5722.00.00	373 460 03 05
4580.00.00	357 460 35 05		5363.00.00	670 460 26 05		5722.00.00	373 460 05 05
4580.00.00	942 330 10 03		5363.00.00	670 460 27 05		5722.00.00	373 460 07 05
4580.00.00	942 330 17 03		5365.00.00	670 460 08 05		5722.00.00	373 460 35 05
4580.00.00	942 330 25 03		5365.00.00	670 460 12 05		5722.00.00	373 460 36 05
4581.00.00	629 330 00 03		5365.00.00	670 460 16 05		5724.00.00	317 460 63 05
4581.00.00	629 330 06 03		5365.00.00	670 460 20 05		5725.00.00	302 330 09 03
4582.00.00	000 460 24 05		5367.96.00	000 350 20 05		5725.00.00	302 330 13 03
4582.00.00	000 460 25 05		5369.10.00	000 460 78 48		5725.00.00	302 330 15 03
4583.00.00	617 460 30 05		5369.10.00	001 460 20 48		5725.00.00	302 330 17 03
4583.00.00	617 460 31 05		5369.20.00	000 460 77 48		5727.00.00	302 460 33 05
4584.00.00	002 460 61 05		5369.20.00	001 460 21 48		5727.00.00	302 460 34 05
4584.00.00	002 460 62 05		5521.96.00	000 330 07 07		5728.00.00	302 460 05 05
4584.00.00	003 460 42 05		5522.96.00	357 330 00 35		5728.00.00	302 460 06 05
4585.00.00	396 460 59 05		5536.20.00	699 460 16 48		5728.00.00	302 460 39 05
4586.00.00	634 323 02 16		5631.00.00	675 460 13 05		5728.00.00	302 460 40 05
4586.00.00	634 323 04 16		5631.00.00	675 460 19 05		5728.00.00	373 460 06 05
4587.00.00	634 323 03 16		5631.00.00	675 460 25 05		5728.00.00	373 460 09 05
4587.00.00	634 323 05 16		5631.00.00	675 460 31 05		5729.00.00	317 460 67 05
4588.00.00	634 326 00 16					5730.00.00	385 330 01 03

FAD	OEM	FAD	OEM	FAD	OEM
5730.00.00	385 330 12 03	5743.20.00	000 460 03 48	5775.00.00	309 460 09 05
5730.00.00	385 330 19 03	5743.20.00	000 460 28 48	5775.00.00	309 460 10 05
5730.00.00	385 330 20 03	5743.20.00	000 460 29 48	5775.00.00	309 460 11 05
5731.00.00	343 330 01 03	5743.20.00	001 460 22 48	5775.00.00	309 460 12 05
5731.00.00	343 330 03 03	5746.10.00	000 330 33 35	5775.00.00	309 460 13 05
5731.00.00	343 330 04 03	5746.10.00	000 330 72 35	5775.00.00	309 460 14 05
5733.10.00	000 330 11 35	5746.10.00	000 330 94 35	5775.00.00	309 460 20 05
5733.20.00	000 338 16 10	5746.10.00	000 330 96 35	5775.00.00	309 460 22 05
5733.20.00	001 330 10 35	5746.20.00	000 330 14 35	5775.00.00	309 460 23 05
5733.20.00	001 330 12 35	5746.20.00	000 330 15 35	5775.00.00	309 460 24 05
5733.20.00	001 330 14 35	5746.20.00	000 330 93 35	5775.00.00	309 460 25 05
5734.00.00	383 460 14 05	5746.20.00	000 330 95 35	5775.00.00	309 460 26 05
5737.00.00	314 330 03 03	5747.00.00	358 330 01 03	5775.00.00	309 460 29 05
5739.00.00	395 320 15 32	5747.00.00	358 330 05 03	5775.00.00	309 460 30 05
5740.00.00	352 460 22 05	5747.00.00	381 330 03 03	5775.00.00	309 460 31 05
5740.00.00	352 460 30 05	5747.00.00	381 330 05 03	5775.00.00	309 460 32 05
5740.00.00	352 460 58 05	5747.00.00	381 330 06 03	5775.00.00	601 460 00 05
5741.00.00	385 330 05 03	5747.00.00	381 330 07 03	5775.00.00	601 460 01 05
5741.00.00	385 330 06 03	5748.00.00	383 460 08 05	5775.00.00	601 460 02 05
5741.00.00	385 330 11 03	5748.00.00	383 460 16 05	5775.00.00	601 460 03 05
5741.00.00	385 330 14 03	5748.00.00	383 460 24 05	5776.00.00	314 460 03 05
5741.00.00	385 330 15 03	5748.00.00	383 460 45 05	5777.00.00	314 460 08 05
5741.10.00	000 330 01 48	5748.20.00	000 330 31 35	5778.00.00	327 460 00 05
5741.10.00	001 330 88 35	5748.20.00	000 330 81 35	5779.00.00	352 460 33 05
5741.10.00	302 330 00 35	5748.20.00	001 330 03 35	5779.00.00	360 460 02 05
5741.10.00	302 330 01 35	5748.20.00	001 330 04 35	5779.00.00	360 460 08 05
5741.10.00	302 330 02 35	5749.00.00	387 460 04 05	5779.00.00	360 460 21 05
5741.10.00	302 330 03 35	5749.00.00	387 460 50 05	5783.38.00	317 330 05 11
5741.10.00	350 330 71 35	5749.00.00	620 460 00 05	5785.38.00	305 330 06 11
5741.20.00	000 330 02 48	5749.00.00	620 460 20 05	5786.38.00	302 330 03 11
5741.20.00	000 330 32 35	5749.00.00	620 460 28 05	5792.00.00	363 460 00 05
5741.20.00	000 338 34 10	5749.00.00	620 460 37 05	5792.00.00	363 460 06 05
5741.20.00	000 460 83 48	5770.00.00	381 350 02 06	5792.00.00	363 460 07 05
5741.20.00	000 463 34 29	5770.00.00	383 350 00 06	5793.00.00	387 460 00 05
5741.20.00	001 330 01 35	5771.00.00	389 320 07 32	5793.00.00	387 460 48 05
5741.20.00	001 330 02 35	5772.00.00	389 320 08 32	5793.00.00	387 460 49 05
5741.20.00	001 460 44 48	5773.00.00	385 350 00 06	5794.00.00	302 460 06 05
5742.20.00	000 460 01 48	5773.00.00	653 350 00 06	5794.00.00	302 460 14 05
5742.20.00	000 460 26 48	5774.20.00	000 330 50 35	5794.00.00	302 460 20 05
5742.20.00	000 460 27 48	5774.20.00	000 460 21 48	5797.10.00	000 330 08 35
5743.00.00	371 330 70 03	5774.20.00	000 460 41 48	5797.20.00	000 330 09 35
5743.00.00	393 330 00 03	5774.20.00	000 460 45 48	5799.00.00	385 460 08 05
5743.00.00	393 330 02 03	5774.20.00	000 460 85 48	5799.00.00	385 460 20 05
5743.00.00	393 330 03 03	5774.20.00	310 330 04 35	5799.00.00	385 460 34 05
5743.00.00	393 330 04 03	5774.20.00	310 330 08 35	5804.00.00	352 330 19 03
5743.10.00	000 460 06 48	5774.20.00	310 330 13 35	5804.00.00	352 330 20 03
5743.10.00	000 460 12 48	5775.00.00	309 460 03 05	5804.00.00	352 330 23 03
5743.10.00	000 460 34 48	5775.00.00	309 460 04 05	5804.00.00	352 330 24 03
5743.10.00	000 460 35 48	5775.00.00	309 460 05 05	5805.00.00	353 330 03 03
5743.10.00	001 460 14 48	5775.00.00	309 460 08 05	5805.00.00	353 330 04 03

# FAD/MERCEDES-BENZ



FAD	OEM	FAD	OEM	FAD	OEM
5805.00.00	353 330 05 03	5821.00.00	617 460 00 05	5839.00.00	647 460 00 05
5805.00.00	353 330 06 03	5821.00.00	617 460 02 05	5839.00.00	647 460 01 05
5805.10.00	000 330 02 35	5821.00.00	617 460 28 05	5840.00.00	352 350 03 06
5805.10.00	000 330 07 35	5822.00.00	620 460 01 05	5842.00.00	395 350 02 06
5805.10.00	000 330 68 35	5822.00.00	620 460 21 05	5842.00.00	659 350 01 06
5805.10.00	000 330 86 35	5822.00.00	620 460 38 05	5842.00.00	659 350 24 06
5805.10.00	000 330 88 35	5822.00.00	620 460 39 05	5843.00.00	307 460 00 05
5805.20.00	000 330 03 35	5823.00.00	316 330 02 03	5843.00.00	307 460 05 05
5805.20.00	000 330 06 35	5823.00.00	316 330 06 03	5844.00.00	395 350 06 06
5805.20.00	000 330 85 35	5823.00.00	316 330 07 03	5845.00.00	395 350 10 06
5805.20.00	000 330 87 35	5825.00.00	327 460 06 05	5845.00.00	624 350 02 06
5805.20.00	000 463 32 29	5825.00.00	327 460 16 05	5845.00.00	659 350 13 06
5806.00.00	327 330 01 03	5826.00.00	310 330 07 03	5845.00.00	659 350 36 06
5806.00.00	327 330 03 03	5826.00.00	310 330 09 03	5846.00.00	381 350 06 06
5806.00.00	327 330 04 03	5826.00.00	310 330 11 03	5846.00.00	652 350 03 06
5806.00.00	352 330 02 03	5826.00.00	730 505	5846.00.00	653 350 01 06
5806.00.00	358 330 00 03	5826.00.00	730 600	5846.90.00	000 586 10 35
5806.00.00	358 330 07 03	5827.00.00	310 330 06 03	5847.90.00	000 350 10 13
5806.00.00	358 330 08 03	5827.00.00	310 330 08 03	5848.10.00	000 330 19 35
5807.00.00	346 330 29 03	5827.00.00	310 330 10 03	5848.10.00	000 330 29 35
5807.00.00	346 330 43 03	5827.00.00	310 330 12 03	5848.10.00	000 330 41 35
5807.00.00	346 330 44 03	5828.00.00	669 330 04 03	5848.10.00	000 330 78 35
5811.00.00	387 460 07 05	5828.00.00	669 330 05 03	5848.10.00	000 338 50 29
5811.00.00	387 460 14 05	5828.00.00	670 330 00 03	5848.10.00	001 330 22 35
5811.00.00	387 460 32 05	5828.00.00	670 330 01 03	5848.10.00	001 330 27 35
5811.00.00	387 460 33 05	5828.00.00	670 330 02 03	5848.20.00	000 330 40 35
5811.00.00	647 460 00 05	5828.00.00	670 330 03 03	5848.20.00	000 330 49 29
5811.00.00	647 460 01 05	5829.00.00	676 330 02 03	5848.20.00	000 330 77 35
5812.00.00	387 460 06 05	5829.00.00	676 330 04 03	5848.20.00	001 330 21 35
5812.00.00	387 460 44 05	5829.00.00	676 330 07 03	5848.20.00	001 330 26 35
5812.00.00	387 460 45 05	5829.00.00	676 330 09 03	5849.00.00	654 350 04 06
5814.00.00	352 330 17 03	5831.00.00	673 460 03 05	5849.00.00	654 350 05 06
5814.00.00	352 330 25 03	5831.00.00	673 460 05 05	5849.00.00	654 352 00 05
5814.00.00	352 330 27 03	5831.00.00	673 460 07 05	5851.00.00	620 350 00 06
5816.00.00	352 460 21 05	5831.00.00	673 460 09 05	5851.00.00	620 350 01 06
5816.00.00	352 460 29 05	5835.00.00	300 460 04 05	5851.00.00	655 350 03 06
5816.00.00	352 460 46 05	5835.00.00	300 460 05 05	5852.00.00	601 460 05 05
5816.00.00	352 460 55 05	5835.00.00	301 460 05 05	5852.00.00	601 460 06 05
5817.00.00	343 330 01 03	5836.00.00	620 330 03 03	5852.00.00	601 460 07 05
5817.00.00	343 330 03 03	5836.00.00	620 330 04 03	5852.00.00	601 460 08 05
5817.00.00	343 330 04 03	5836.00.00	620 330 07 03	5852.00.00	601 460 09 05
5818.00.00	352 330 18 03	5836.00.00	620 330 08 03	5852.00.00	601 460 10 05
5818.00.00	352 330 26 03	5837.00.00	302 330 09 03	5852.00.00	601 460 11 05
5818.00.00	352 330 28 03	5837.00.00	302 330 13 03	5852.00.00	601 460 12 05
5820.00.00	343 460 04 05	5837.00.00	302 330 15 03	5852.00.00	601 460 13 05
5820.00.00	343 460 08 05	5837.00.00	302 330 17 03	5852.00.00	601 460 15 05
5820.00.00	343 460 10 05	5839.00.00	387 460 07 05	5854.00.00	307 330 01 11
5820.00.00	343 460 12 05	5839.00.00	387 460 14 05	5854.00.00	357 330 36 11
5820.00.00	343 460 14 05	5839.00.00	387 460 32 05	5854.90.00	000 586 09 32
5820.00.00	343 460 15 05	5839.00.00	387 460 33 05	5855.10.00	000 460 58 48

FAD	OEM	FAD	OEM	FAD	OEM
5855.10.00	000 460 61 48	5875.00.00	300 460 02 05	5899.20.00	000 463 26 29
5855.10.00	000 460 69 48	5875.00.00	300 460 03 05	5900.20.00	000 463 24 29
5855.10.00	000 460 71 48	5875.00.00	301 460 00 05	5900.20.00	000 463 25 29
5855.10.00	001 460 05 48	5875.00.00	301 460 01 05	5904.20.00	000 460 49 48
5855.10.00	001 460 13 48	5881.00.00	317 460 57 05	5905.00.00	000 460 28 05
5855.20.00	000 460 57 48	5881.00.00	317 460 58 05	5905.00.00	000 460 36 05
5855.20.00	000 460 60 48	5882.00.00	317 460 69 05	5905.00.00	000 460 51 05
5855.20.00	000 460 68 48	5882.00.00	317 460 71 05	5905.00.00	625 460 43 05
5855.20.00	000 460 70 48	5885.00.00	360 460 03 05	5905.00.00	625 460 77 05
5855.20.00	000 460 75 48	5885.00.00	360 460 09 05	5906.00.00	000 460 39 05
5855.20.00	001 460 11 48	5885.00.00	360 460 22 05	5906.00.00	625 460 38 05
5855.20.00	001 460 17 48	5886.00.00	602 330 00 03	5906.00.00	625 460 43 05
5855.20.00	001 460 24 48	5886.00.00	602 330 01 03	5906.00.00	625 460 52 05
5855.20.00	001 460 76 48	5886.00.00	602 330 03 03	5906.00.00	625 460 79 05
5856.20.00	001 330 18 35	5886.00.00	602 330 04 03	5907.00.00	625 460 25 05
5858.00.00	620 350 00 06	5886.00.00	602 330 55 03	5944.96.00	000 350 28 05
5858.00.00	620 350 01 06	5886.10.00	601 330 05 35	5956.00.00	357 333 02 05
5858.00.00	655 350 03 06	5886.20.00	601 330 04 35	5976.00.00	357 330 06 03
5860.00.00	387 460 15 05	5887.00.00	305 460 06 05	5976.00.00	357 330 07 03
5860.00.00	387 460 35 05	5887.00.00	357 460 12 05	6021.96.00	000 350 10 05
5860.00.00	387 460 36 05	5887.00.00	357 460 13 05	6023.96.00	000 350 25 05
5860.00.00	647 460 02 05	5888.00.00	673 460 02 05	6039.00.00	357 333 04 05
5860.00.00	647 460 03 05	5888.00.00	673 460 04 05	6050.00.00	356 330 00 03
5862.00.00	302 330 11 03	5888.00.00	673 460 06 05	6050.00.00	613 330 00 03
5862.00.00	302 330 14 03	5888.00.00	673 460 08 05	6051.00.00	356 330 02 03
5862.00.00	302 330 16 03	5889.00.00	001 460 96 05	6052.00.00	356 463 02 15
5863.00.00	676 330 08 03	5890.00.00	617 460 32 05	6053.00.00	356 463 00 15
5863.00.00	676 330 10 03	5890.00.00	617 460 33 05	6053.00.00	613 463 00 15
5864.00.00	620 330 05 03	5891.00.00	385 350 00 06	6054.00.00	356 330 01 03
5864.00.00	620 330 06 03	5891.00.00	653 350 00 06	6054.00.00	613 330 01 03
5865.00.00	357 460 04 05	5893.00.00	305 460 04 05	6107.20.00	624 460 03 48
5865.00.00	357 460 10 05	5895.20.00	602 330 02 35	6197.00.00	629 350 05 06
5865.00.00	357 460 11 05	5895.20.00	602 330 03 35	6197.00.00	629 350 06 06
5866.00.00	677 330 03 03	5896.10.00	310 330 01 35	6407.00.00	945 350 01 05
5866.00.00	677 330 04 03	5896.10.00	310 330 16 35	6407.00.00	948 350 25 05
5869.00.00	385 330 04 03	5896.10.00	310 330 21 35	6409.96.00	444 333 01 27
5869.00.00	385 330 19 03	5896.10.00	310 330 25 35	6881.00.00	002 460 43 05
5869.00.00	385 330 20 03	5896.20.00	310 330 00 35	6881.00.00	002 460 44 05
5871.00.00	346 330 39 03	5896.20.00	310 330 17 35	6881.20.00	001 460 42 48
5871.00.00	346 330 49 03	5896.20.00	310 330 20 35	6881.20.00	001 460 50 48
5872.00.00	391 330 06 03	5896.20.00	310 330 24 35	6881.20.00	001 460 85 48
5872.00.00	391 330 08 03	5897.10.00	310 330 03 35	6882.00.00	002 460 45 05
5872.00.00	391 330 10 03	5897.10.00	310 330 19 35	6882.00.00	002 460 46 05
5872.00.00	391 330 12 03	5897.10.00	310 330 23 35	6885.00.00	628 333 00 03
5873.00.00	387 460 15 05	5897.10.00	310 330 27 35	6885.00.00	628 333 00 05
5873.00.00	387 460 35 05	5897.20.00	310 330 02 35	6885.00.00	628 333 10 05
5873.00.00	387 460 36 05	5897.20.00	310 330 18 35	6885.00.00	628 333 18 05
5873.00.00	647 460 02 05	5897.20.00	310 330 22 35	6887.00.00	000 460 41 05
5873.00.00	647 460 03 05	5897.20.00	310 330 26 35	6887.00.00	000 460 55 05
5874.00.00	625 330 04 03	5899.20.00	000 463 23 29	6887.00.00	625 460 42 05

# FAD/MERCEDES-BENZ



FAD	OEM	FAD	OEM	FAD	OEM
6887.00.00	625 460 78 05				
6900.00.00	671 460 02 05				
6901.00.00	357 330 11 03				
6901.00.00	357 330 15 03				
6902.00.00	357 460 32 05				
6902.00.00	671 460 03 05				
6904.00.00	671 333 01 05				
6905.00.00	357 333 05 05				
6905.00.00	671 333 02 05				
6906.00.00	357 333 07 05				
6906.00.00	671 333 04 05				
6909.00.00	628 330 05 03				
6910.00.00	357 330 19 11				
6910.00.00	357 330 33 11				
6913.00.00	628 333 09 05				
6913.00.00	628 333 17 05				
6914.00.00	632 350 01 06				
6916.00.00	001 460 79 05				
6916.00.00	003 460 39 05				
6917.00.00	975 330 06 03				
6917.00.00	975 330 07 03				
6917.00.00	975 330 09 03				
6918.00.00	628 333 01 05				
6919.00.00	666 330 00 11				
6922.00.00	375 460 06 05				
6922.00.00	375 460 11 05				
6924.00.00	002 460 10 05				
6924.00.00	003 460 29 05				
6924.00.00	000 460 85 05				
6925.00.00	699 460 42 05				
6926.00.00	699 460 84 05				
6926.00.00	699 460 98 05				
6927.00.00	699 460 05 05				
7385.20.00	440 460 03 48				
7414.20.00	000 330 56 35				
7414.20.00	000 338 18 10				
7414.20.00	000 460 43 48				
7414.20.00	000 460 56 48				
7414.20.00	310 330 06 35				
7414.20.00	310 330 10 35				
7414.20.00	310 330 12 35				
7523.20.00	000 463 40 29				
7523.20.00	000 463 41 29				

FAD	OEM
3573.00.00	665 197
3576.00.00	678 612
3579.00.00	665 196
3581.00.00	660 915
3581.10.00	660 916
3581.20.00	660 917
3582.00.00	660 856
3583.00.00	832 45
3584.00.00	660 977
3585.00.00	900 20
3586.00.00	660 976
3587.00.00	665 178
3588.00.00	900 81
3593.00.00	685 201
3595.00.00	683 795
3597.00.00	699 432
3598.00.00	700 875
3599.00.00	737 710
3646.00.00	917 20
4333.00.00	837 57
4333.00.00	839.53.3143.000
4334.00.00	A4815-20
4335.00.00	A4815-21
4336.00.00	A4815-22
4337.00.00	783.24.3143.000
4337.00.00	863 97
4345.00.00	4922-02/1962
4345.00.00	918 42
4387.00.00	996 56
4440.00.00	143 929
4441.00.00	144 228
5198.00.00	832.00.3183.000
5741.10.00	678 621
5741.20.00	678 622
5743.10.00	660 857
5743.20.00	660 858
5746.10.00	654 136
5914.00.00	836.01.3504.000
5927.00.00	997 324
5928.00.00	377 740
7720.20.00	619 687

FAD	OEM	FAD	OEM	FAD	OEM
3282.00.00	50 10 094 840	4675.00.00	50 10 098 467	4710.00.00	50 01 868 367
3283.00.00	00 00 691 970	4675.00.00	50 10 145 584	4710.00.00	50 10 587 050
3284.00.00	50 10 025 292	4675.00.00	50 10 439 631	4710.00.00	50 10 587 053
3284.96.00	50 00 814 841	4676.00.00	50 10 308 082	4711.00.00	20 847 191
3285.00.00	50 10 005 937	4676.00.00	50 10 566 059	4711.00.00	7420 847 190
3286.00.00	50 10 197 399	4677.00.00	50 10 216 608	4712.00.00	50 10 488 084
3287.00.00	50 10 207 168	4678.00.00	50 10 395 796	4712.00.00	50 10 488 639
3288.00.00	50 10 207 771	4678.00.00	50 10 566 049	4712.00.00	50 10 488 759
3289.00.00	00 23 123 220	4679.00.00	50 00 613 837	4712.00.00	50 10 557 341
3289.00.00	1 151 394	4680.00.00	50 10 308 214	4713.00.00	50 10 488 051
3291.00.00	50 10 130 344	4680.00.00	50 10 439 984	4714.00.00	50 10 566 157
3292.00.00	50 00 785 429	4681.00.00	50 10 439 022	4715.00.00	50 10 395 797
3293.00.00	00 23 123 247	4681.20.00	50 01 858 763	4715.00.00	50 10 566 050
3293.00.00	50 00 748 868	4682.00.00	50 10 439 021	4716.00.00	50 10 499 243
3293.00.00	50 00 874 577	4682.00.00	50 10 566 063	4716.00.00	50 10 517 082
3293.00.00	50 10 130 453	4683.00.00	50 10 587 004	4718.00.00	50 10 383 203
3296.00.00	50 00 725 267	4683.00.00	50 10 600 822	4718.00.00	50 10 488 836
3296.00.00	50 10 144 549	4684.00.00	50 10 630 822	4719.00.00	50 10 488 146
3296.00.00	50 10 144 552	4684.00.00	50 10 630 823	4720.00.00	50 10 488 052
3297.00.00	50 10 060 764	4685.00.00	50 10 587 034	4721.00.00	50 10 488 166
3297.00.00	50 10 557 243	4685.00.00	50 10 587 038	4722.00.00	50 10 488 165
3298.00.00	00 23 123 247	4686.00.00	50 10 600 483	4724.00.00	50 10 259 241
3298.00.00	50 00 748 868	4687.00.00	50 10 630 812	4724.00.00	50 10 557 234
3298.00.00	50 00 874 577	4687.00.00	50 10 630 813	4724.00.00	50 10 557 524
3298.00.00	50 10 130 453	4688.00.00	7420 630 813	4725.00.00	50 10 064 715
3590.20.00	00 23 162 046	4690.00.00	50 10 094 839	4725.00.00	50 10 130 382
3590.20.00	50 00 516 214	4692.00.00	50 01 868 374	4725.00.00	74 85 114 932
3590.20.00	50 10 144543	4692.00.00	50 10 630 637	4730.00.00	50 10 294 320
3637.96.00	50 01 840 095	4692.00.00	50 10 630 638	4731.00.00	50 10 151 528
3698.90.00	77 01 011 267	4693.00.00	25 379 292	4731.00.00	50 10 207 724
3944.00.00	50 10 207 726	4693.00.00	50 01 868 383	4731.00.00	50 00 761 671
3945.00.00	50 10 207 727	4693.00.00	50 10 630 820	4732.00.00	50 10 393 015
3948.00.00	50 10 037 602	4693.00.00	50 10 630 821	4733.00.00	50 01 868 404
3948.00.00	50 10 037 603	4694.00.00	50 10 557 523	4733.00.00	50 10 587 049
3948.00.00	50 10 130 456	4695.00.00	50 10 630 254	4733.00.00	50 10 587 052
4163.20.00	50 01 823 718	4696.00.00	50 10 488 336	4733.00.00	74 21 560 965
4660.00.00	50 00 786 532	4696.00.00	50 10 557 233	4735.00.00	50 10 224 899
4661.00.00	00 23 123 262	4697.00.00	50 10 488 096	4736.00.00	50 10 308 083
4666.00.00	23 123 224	4698.00.00	50 10 229 243	4737.00.00	50 01 860 360
4666.00.00	50 10 145 077	4698.00.00	50 10 488 053	5170.96.00	50 01 842 823
4667.00.00	720 128	4699.00.00	50 10 439 023	5524.90.00	50 01 014 520
4668.00.00	50 10 294 288	4699.00.00	50 10 566 062	5741.10.00	00 03 406 213
4669.00.00	50 10 294 289	4700.00.00	50 10 207 728	5741.10.00	00 03 406 218
4670.00.00	50 10 294 287	4701.00.00	50 10 207 729	5741.10.00	50 00 295 215
4672.00.00	50 01 860 359	4702.00.00	50 10 207 725	5741.10.00	50 01 850 550
4673.00.00	50 00 145 581	4703.00.00	50 00 450 713	5741.10.00	50 01 852 263
4673.00.00	50 00 791 032	4704.00.00	50 00 450 714	5741.20.00	00 03 406 212
4673.00.00	50 10 308 215	4707.00.00	50 10 557 423	5741.20.00	00 03 406 253
4673.00.00	50 10 791 275	4708.00.00	50 10 488 164	5741.20.00	50 00 242 159
4674.00.00	50 10 145 078	4709.00.00	50 10 439 078	5741.20.00	50 00 295 214

# FAD/RENAULT



FAD	OEM	FAD	OEM	FAD	OEM
5741.20.00	50 00 812 483	5980.00.00	00 00 566 157		
5741.20.00	50 01 850 549	5981.00.00	00 00 745 019		
5741.20.00	77 01 016 946	5982.00.00	00 23 123 253		
5742.20.00	50 00 808 458	5983.00.00	00 23 123 252		
5742.20.00	77 01 002 911	5983.00.00	50 00 788 392		
5743.10.00	00 03 401 170	5985.00.00	00 23 123 253		
5743.10.00	50 00 288 361	5985.00.00	50 00 750 976		
5743.10.00	50 01 832 581	5985.00.00	50 00 783 574		
5743.20.00	00 03 406 169	5985.00.00	50 01 850 530		
5743.20.00	00 03 406 236	5985.00.00	50 10 064 641		
5743.20.00	00 03 406 251	5985.00.00	50 10 094 838		
5743.20.00	00 03 406 254	5985.00.00	50 10 094 941		
5743.20.00	00 03 406 260	5987.00.00	00 23 123 159		
5743.20.00	00 03 406 261	5992.96.00	50 00 819 365		
5743.20.00	50 00 288 360	5992.96.00	50 10 104 465		
5743.20.00	50 00 590 236	5993.00.00	00 23 123 275		
5743.20.00	50 00 804 824	5994.00.00	50 10 268 035		
5743.20.00	77 01 011 412	5995.00.00	23 123 256		
5746.10.00	50 00 559 336	5996.00.00	00 23 123 233		
5746.10.00	50 00 823 947	5998.10.00	00 03 401 150		
5746.10.00	50 00 823 997	5998.10.00	50 00 803 462		
5752.00.00	50 10 145 077	5998.20.00	00 03 401 149		
5755.00.00	00 23 123 237	5998.20.00	50 00 803 461		
5755.00.00	1 151 395	6359.00.00	50 10 097 562		
5755.00.00	23 123 237	7474.20.00	50 00 792 132		
5755.96.00	50 00 802 123	7762.00.00	50 10 566 058		
5757.00.00	00 23 123 238				
5757.00.00	1 151 396				
5757.00.00	23 123 238				
5759.00.00	00 23 123 265				
5760.00.00	00 23 123 225				
5760.00.00	00 23 123 240				
5760.00.00	23 123 225				
5760.00.00	23 123 240				
5760.00.00	50 01 826 368				
5805.10.00	50 00 807 553				
5805.10.00	50 00 814 096				
5805.10.00	50 01 844 135				
5805.20.00	00 03 406 252				
5805.20.00	50 00 807 554				
5805.20.00	50 00 814 097				
5805.20.00	50 01 844 136				
5856.10.00	00 03 401 206				
5856.10.00	50 01 832 579				
5856.20.00	00 03 401 207				
5856.20.00	50 01 831 481				
5856.20.00	50 01 832 580				
5910.00.00	50 00 027 957				
5910.00.00	50 00 810 038				



FAD	OEM	FAD	OEM	FAD	OEM
3081.00.00	390 784	4785.00.00	477 889	6835.00.00	1 343 266
3082.00.00	1 384 025	4787.00.00	486 590	6835.00.00	1 759 690
3082.00.00	1 768 898	4788.00.00	488 056	6836.00.00	388 943
3083.00.00	1 338 769	4789.00.00	1 500 572	6837.00.00	421 573
3083.00.00	1 428 347	4790.00.00	1 367 282	6838.00.00	1 343 283
3084.00.00	1 326 775	4791.00.00	1 399 182	6838.00.00	1 759 691
3087.00.00	1 304 569	4792.00.00	1 438 475	6840.00.00	291 396
3089.20.00	1 383 405	4793.00.00	1 527 978	6841.00.00	1 393 298
3126.00.00	1 397 866	4793.00.00	1 723 896	6842.00.00	1 324 890
3126.00.00	1 734 020	4793.00.00	1 737 684	6843.00.00	1 420 698
3126.00.00	395 350	4793.00.00	1 897 336	6844.00.00	483 527
3138.00.00	414 531	4795.00.00	434 493	6847.00.00	1 384 027
3148.00.00	278 665	5048.96.00	114 406	6847.00.00	1 769 597
3149.00.00	306 981	5170.96.00	1 104 335	6849.00.00	1 394 884
3343.00.00	1 379 423	5170.96.00	638 862	6851.00.00	1 766 015
3348.00.00	345 124	5170.96.00	639 287	6851.00.00	445 626
3361.00.00	445 599	5323.96.00	1 104 334	6852.20.00	1 357 674
3361.00.00	489 989	5323.96.00	550 806	6853.00.00	445 629
3362.00.00	465 816	5323.96.00	639 370	6860.00.00	1 499 476
3362.00.00	466 801	5587.96.00	1 104 336	6860.00.00	1 722 748
3362.00.00	489 987	5743.10.00	1 358 792	6861.00.00	1 499 474
3363.00.00	621 863	5743.10.00	1 738 380	6861.00.00	1 722 746
3363.96.00	638 860	5743.10.00	283 783	6862.00.00	1 499 475
3364.00.00	649 346	5743.10.00	395 009	6862.00.00	1 722 747
3365.00.00	651 156	5743.20.00	1 358 793	6863.00.00	1 499 477
3366.00.00	651 157	5743.20.00	1 738 381	6863.00.00	1 722 749
3367.00.00	651 158	5743.20.00	1 767 328	6864.00.00	1 485 760
3368.00.00	409 639	5743.20.00	283 784	6864.00.00	1 499 478
3369.00.00	417 290	5743.20.00	395 010	6864.00.00	1 722 750
3581.20.00	1 337 367	5810.10.00	1 337 366	6865.00.00	1 499 479
4126.20.00	1 488 890	5810.10.00	352 645	6865.00.00	1 722 751
4126.20.00	1 534 756	5810.20.00	1 337 367	6868.00.00	416 159
4770.00.00	1 897 669	5810.20.00	352 646	7523.20.00	1 376 902
4770.00.00	481 217	5847.96.00	638 861	7981.20.00	1 394 443
4771.00.00	415 400	6409.96.00	550 808	7982.20.00	1 394 444
4773.00.00	1 369 917	6830.00.00	1 334 139		
4776.00.00	1 343 278	6831.00.00	1 399 180		
4777.00.00	1 897 671	6832.00.00	1 361 413		
4778.00.00	417 676	6832.00.00	1 395 614		
4779.00.00	1 431 472	6832.00.00	1 734 019		
4779.00.00	1 770 732	6832.00.00	1 897 333		
4779.00.00	477 890	6832.20.00	1 357 674		
4780.00.00	1 485 758	6833.00.00	1 385 251		
4780.00.00	1 486 757	6833.00.00	1 409 918		
4781.00.00	1 486 758	6833.00.00	1 501 030		
4782.00.00	1 431 475	6833.00.00	1 723 895		
4782.00.00	481 959	6833.00.00	1 737 683		
4783.00.00	488 738	6833.00.00	1 897 335		
4784.00.00	488 739	6834.00.00	1 897 673		
4785.00.00	1 431 471	6834.00.00	475 463		

FAD	OEM	FAD	OEM	FAD	OEM
3071.00.00	1 576 092	4234.00.00	20 581 086	4733.00.00	25 370 844
3074.00.00	1 576 092	4234.10.00	20 710 008	4733.00.00	74 21 560 965
3074.00.00	1 606 283	4234.20.00	20 581 089	4746.20.00	1696 920
3075.00.00	1 592 939	4236.00.00	20 375 787	5121.90.00	271 188
3075.00.00	85 114 144	4236.00.00	21 106 933	5136.00.00	1 626 494
3546.10.00	1 505 758	4237.00.00	9 959 503	5140.00.00	6 771 112
3546.10.00	1 507 822	4240.00.00	6 777 705	5141.00.00	1 075 663
3546.10.00	1 698 533	4241.20.00	20 374 698	5141.00.00	20 393 069
3546.10.00	1 698 847	4242.00.00	1 135 630	5141.00.00	3 988 704
3546.20.00	1 505 759	4243.00.00	1 075 006	5323.96.00	271 187
3546.20.00	1 507 823	4243.00.00	85 114 190	5386.96.00	273 612
3546.20.00	1 698 532	4244.00.00	20 400 942	5388.90.00	1 134 955
3546.20.00	1 698 846	4244.00.00	6 790 607	5493.00.00	1 197 338
3590.20.00	6 027 074	4244.00.00	6 790 766	5494.00.00	20 490 123
3590.20.00	6 853 913	4245.00.00	1 599 175	5494.00.00	20 745 923
3744.96.00	274 068	4245.00.00	1 613 351	5494.00.00	21 308 022
4163.20.00	3 099 129	4245.00.00	1 626 671	5494.00.00	9 519 278
4200.00.00	3 962 843	4247.00.00	1 134 840	5494.20.00	3 097 999
4208.00.00	3 124 964	4248.00.00	1 628 635	5494.20.00	85 104 188
4208.00.00	6 799 190	4248.00.00	20 393 079	5524.90.00	3 133 173
4208.20.00	1 697 246	4248.00.00	3 988 708	5580.90.00	1 075 255
4208.20.00	1 698 047	4248.00.00	3 988 710	5580.90.00	1 591 689
4209.00.00	3 116 050	4250.00.00	20 400 940	5580.90.00	20 554 908
4210.00.00	8 132 373	4250.00.00	1 071 170	5580.90.00	3 173 759
4211.00.00	3 039 647	4251.00.00	1 576 816	5581.90.00	1 598 588
4212.00.00	1 611 880	4251.00.00	1 587 489	5584.00.00	1 589 817
4212.00.00	1 626 670	4251.00.00	1 606 282	5586.00.00	20 556 490
4216.00.00	1 094 219	4252.00.00	1 197 339	5586.00.00	3 173 291
4218.00.00	3 173 613	4256.00.00	1 075 260	5586.90.00	1 628 107
4218.00.00	3 987 354	4256.00.00	1 629 072	5587.00.00	1 080 690
4219.00.00	1 094 334	4257.00.00	8 190 034	5587.00.00	1 606 200
4219.00.00	1 575 690	4258.00.00	1 626 957	5587.96.00	274 056
4220.00.00	20 393 071	4259.00.00	20 410 053	5587.96.00	276 192
4220.00.00	8 190 146	4259.00.00	21 106 157	5589.90.00	274 069
4222.20.00	3 097 228	4260.00.00	6 799 189	5594.00.00	1 581 527
4222.20.00	3 099 529	4262.00.00	20 367 555	5594.00.00	1 607 079
4223.00.00	1 592 940	4263.00.00	20 477 807	5594.00.00	8 154 017
4223.00.00	85 114 145	4263.00.00	3 944 046	5594.00.00	8 158 206
4224.00.00	1 075 664	4264.00.00	20 453 123	5594.00.00	8 158 207
4224.00.00	20 393 063	4265.00.00	20 383 080	5594.96.00	273 373
4224.00.00	3 988 701	4265.00.00	21 252 481	5594.96.00	274 019
4225.00.00	1 629 668	4266.00.00	20 383 081	5594.96.00	4 941 233
4225.00.00	20 477 805	4266.00.00	21 260 283	5595.00.00	1 610 338
4225.00.00	3 986 433	4267.00.00	20 742 117	5595.00.00	1 626 751
4229.00.00	20 400 909	4267.00.00	1 524 382	5596.00.00	1 628 636
4229.00.00	3 124 480	4490.96.00	3 198 309	5596.00.00	85 114 200
4229.00.00	3 124 594	4693.00.00	20 727 840	5596.10.00	3 090 728
4229.00.00	6 777 855	4710.00.00	25 370 845	5596.10.00	3 110 001
4232.00.00	3 173 614	4712.00.00	20 818 854	5596.10.00	3 988 968
4233.20.00	3 093 647	4733.00.00	21 560 965	5596.20.00	3 090 727

FAD	OEM	FAD	OEM	FAD	OEM
5596.20.00	3 092 472	6275.00.00	20 994 419	6739.00.00	6 790 572
5596.20.00	3 988 965	6276.00.00	20 375 555	6744.00.00	3 172 829
5597.00.00	1 135 427	6276.00.00	20 393 186	6746.00.00	1 612 254
5597.90.00	113 50 30	6276.00.00	21 106 930	6746.00.00	20 393 097
5598.00.00	1 606 551	6276.00.00	3 986 452	6746.00.00	21 260 286
5598.00.00	8 154 016	6278.00.00	20 393 091	6746.00.00	3 985 570
5599.00.00	1 135 427	6278.00.00	20 442 113	6747.00.00	20 393 061
5746.10.00	1 517 439	6278.00.00	20 513 951	6747.00.00	3 988 697
5746.10.00	1 698 190	6278.00.00	24 425 660	6748.00.00	3 098 294
5746.20.00	1 517 440	6281.00.00	3 112 282	6748.00.00	85 104 265
5746.20.00	1 517 444	6283.00.00	21 461 309	6750.00.00	1 573 572
5746.20.00	1 698 191	6283.00.00	70 371 272	6750.10.00	1 608 352
5805.10.00	1 517 448	6284.00.00	20 374 444	6750.20.00	1 608 351
5805.20.00	1 190 778	6284.00.00	20 410 530	6751.00.00	1 135 428
5805.20.00	1 517 449	6284.00.00	20 509 018	6751.90.00	1 136 891
5805.20.00	1 518 142	6720.00.00	20 367 004	6753.00.00	1 194 390
5943.90.00	273 706	6720.00.00	20 507 262	6754.00.00	8 156 123
5945.90.00	273 375	6720.00.00	20 741 695	6755.00.00	9 523 795
6260.00.00	20 739 082	6720.00.00	20 741 703	6756.00.00	1 135 429
6260.00.00	70 311 664	6720.00.00	7420 741 703	6756.00.00	8 365 399
6261.00.00	20 497 798	6721.00.00	20 382 314	6758.00.00	1 082 104
6261.00.00	3 112 050	6721.00.00	20 502 944	6758.00.00	1 605 035
6261.00.00	9 959 151	6723.00.00	20 556 490	6759.00.00	9 523 794
6262.00.00	20 443 063	6723.00.00	3 173 291	6761.00.00	20 556 491
6262.00.00	20 443 067	6725.00.00	1 075 005	6761.00.00	3 173 292
6262.00.00	20 994 420	6726.00.00	20 390 745	6762.20.00	1 527 234
6263.00.00	20 497 799	6726.00.00	21 106 936	6762.20.00	382 745
6263.00.00	3 112 273	6727.00.00	21 260 274	6765.00.00	1 130 568
6263.00.00	9 959 152	6727.00.00	3 198 276	6767.00.00	6 853 511
6263.10.00	3 098 295	6728.00.00	21 260 275	6768.00.00	1 088 985
6263.10.00	85 104 266	6728.00.00	3 198 234	6768.00.00	20 393 083
6264.00.00	1 071 344	6729.00.00	1 083 744	6769.00.00	1 626 637
6264.00.00	20 400 944	6730.00.00	8 154 444	6769.00.00	3 962 343
6264.00.00	3 127 737	6731.00.00	20 497 800	6769.00.00	3 988 711
6265.00.00	9 959 462	6731.00.00	3 112 122	7720.00.00	1 576 093
6266.00.00	20 443 061	6731.00.00	9 959 153	7720.00.00	1 606 284
6266.00.00	20 443 065	6732.00.00	1 080 792	7720.10.00	1 695 840
6266.00.00	20 994 418	6732.00.00	6 862 225	7720.20.00	1 507 826
6267.00.00	20 374 831	6733.00.00	1 130 567	7720.20.00	1 695 585
6267.00.00	21 252 480	6733.00.00	1 612 781	7720.20.00	1 695 776
6268.00.00	20 393 187	6733.00.00	1 614 838	7720.20.00	1 698 557
6268.00.00	21 406 952	6733.00.00	85 114 197		
6272.00.00	24 425 411	6734.00.00	1 588 263		
6273.00.00	70 311 665	6734.00.00	1 606 277		
6274.00.00	21 426 652	6734.00.00	1 626 493		
6274.00.00	21 525 324	6737.00.00	20 556 492		
6274.00.00	70 311 662	6737.00.00	3 173 293		
6274.00.00	85 115 635	6738.00.00	1 628 483		
6275.00.00	20 443 062	6738.00.00	20 556 586		
6275.00.00	20 443 066	6738.00.00	3 173 294		